

A	B	C	D
1	AB1 - 404	1750	700
			1/2

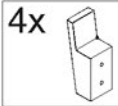

4x g503

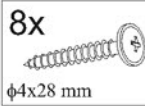

8x

φ4x28 mm

p94

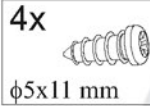

4x

φ5x11 mm

e4



2x

g2

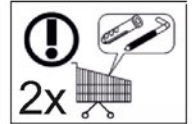

1

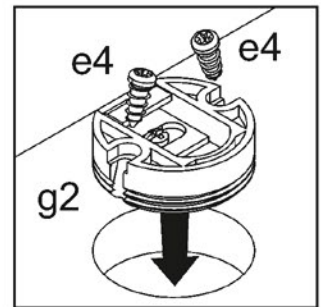
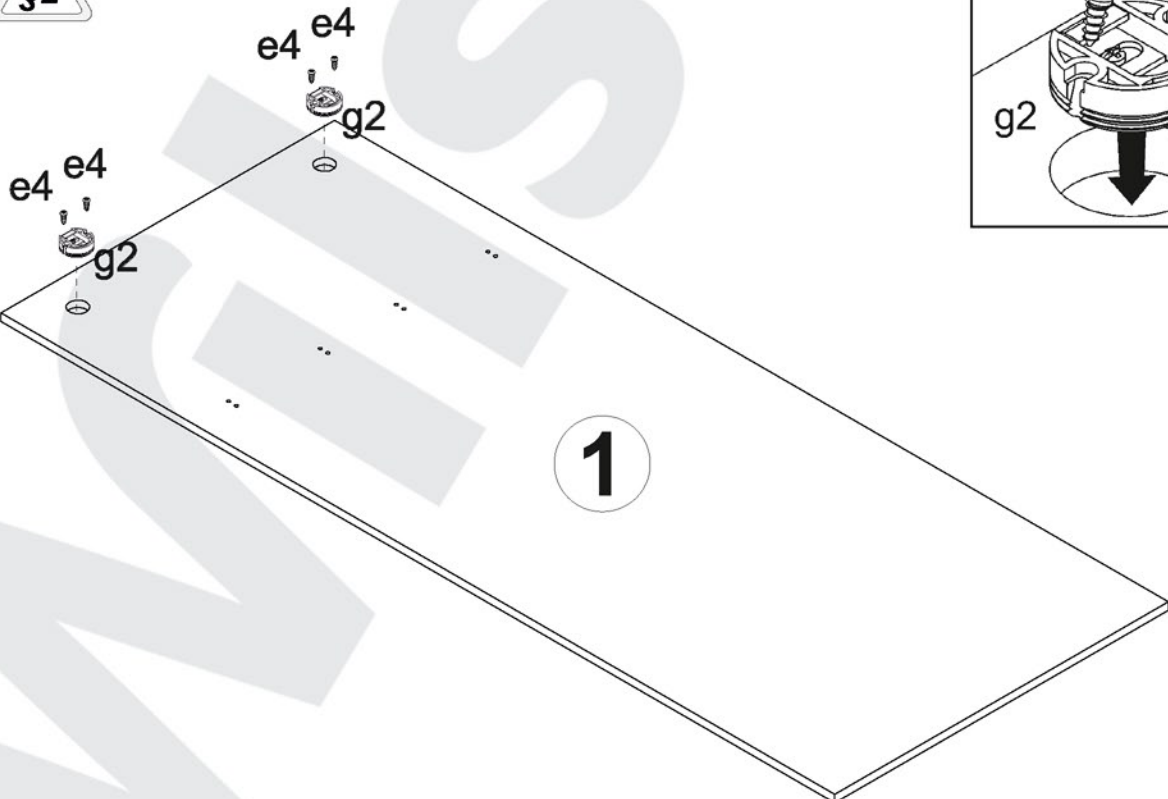

2 

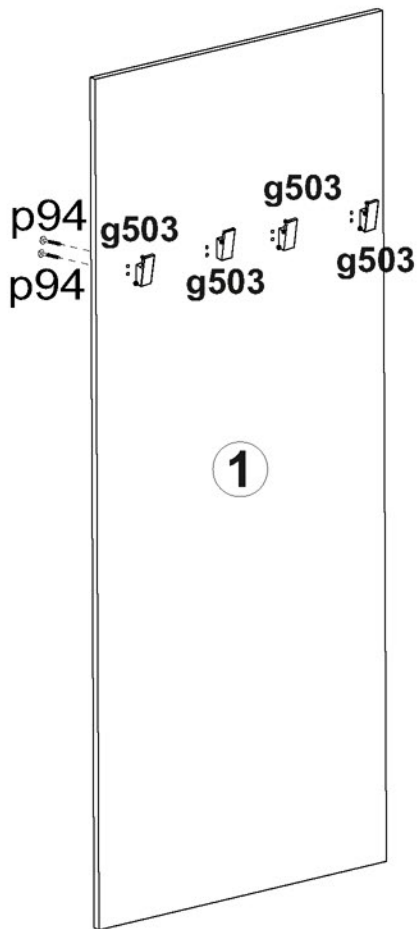

3 

