

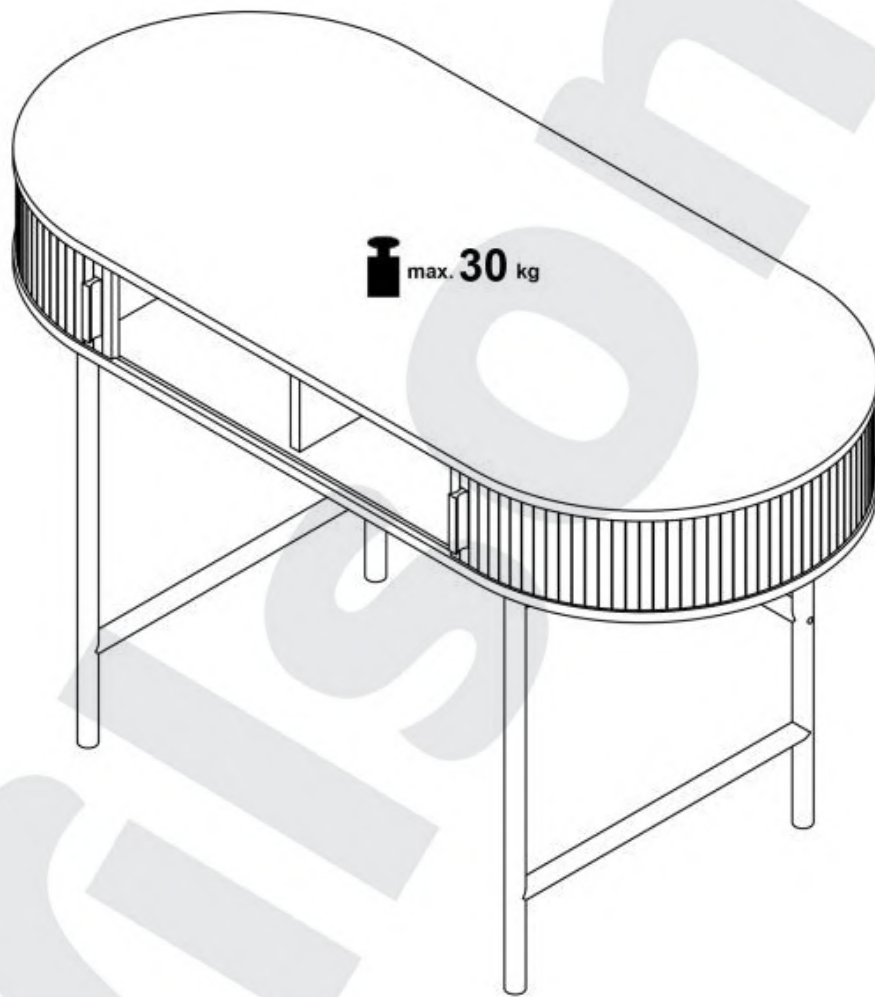

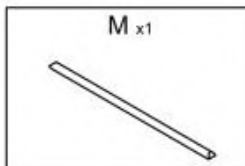

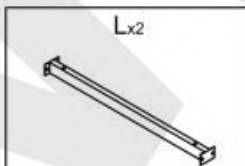

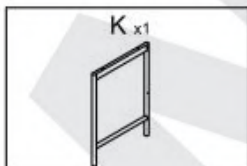

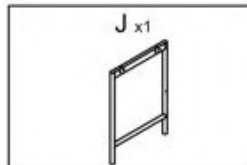
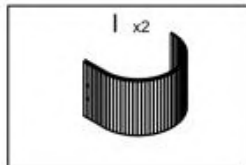
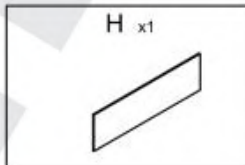
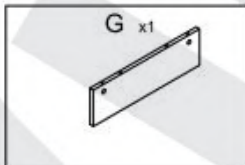
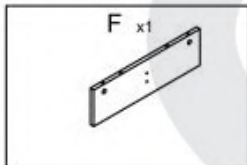
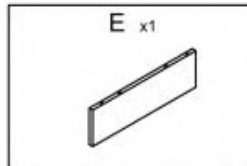
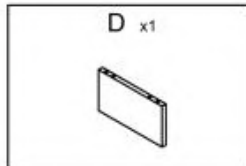
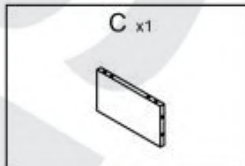
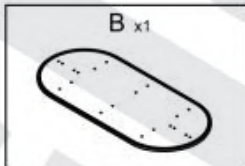
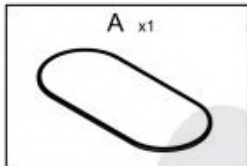
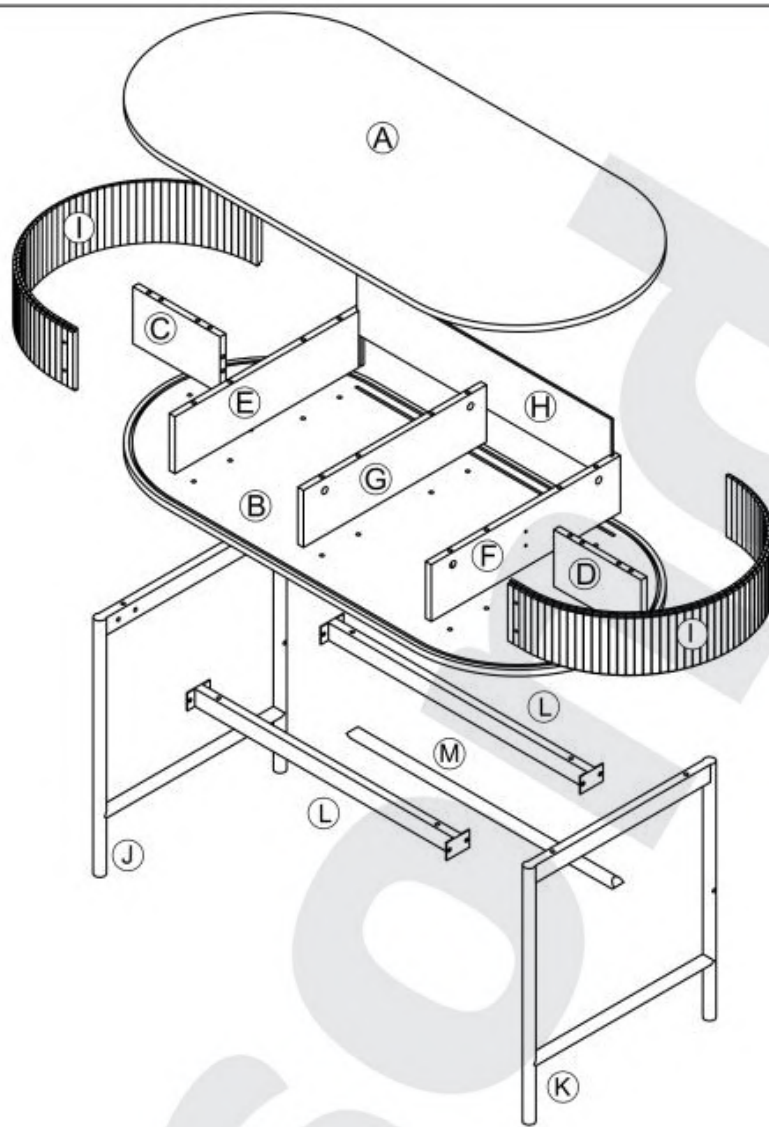

# B-51



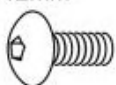
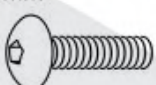
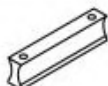

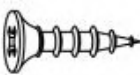
N	Ø6*35mm 	14	O	Ø15mm 	14
P	M7*50mm 	10	Q	Ø8*30mm 	20
R	Ø20mm 	14	S	M4 	1
T	M6*12mm 	8	U	M6*50mm 	10
V		2	W	M4*8mm 	4
X	Ø3.5*14mm 	6	Y		6

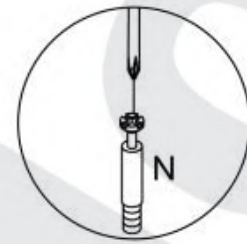
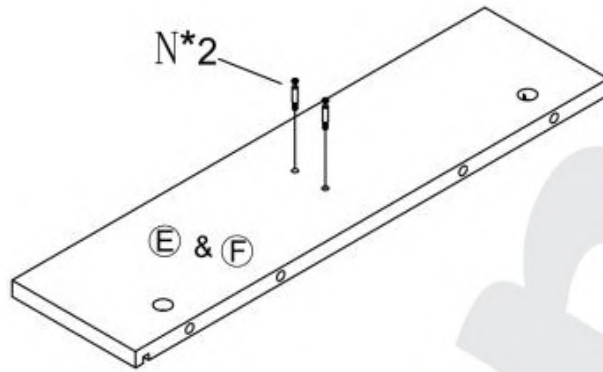

1:



N	X4
	
M6*35mm	

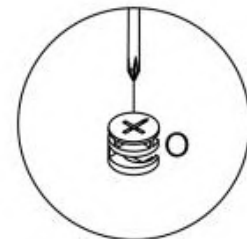
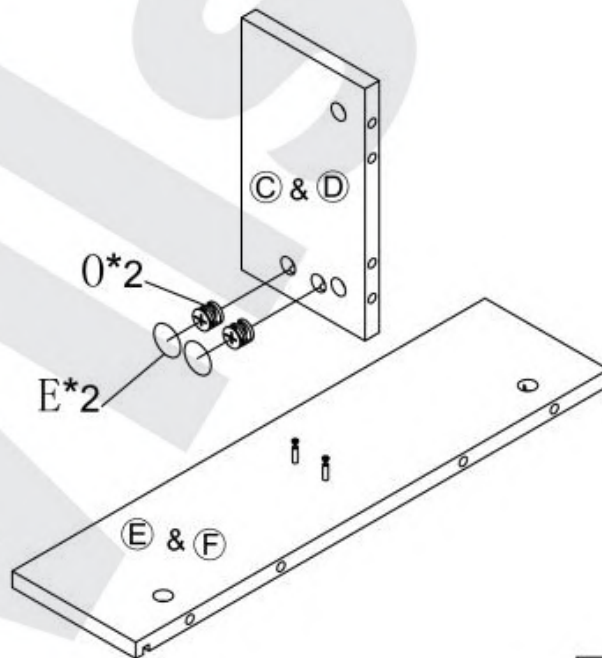

2:



O	X4	R	X4
			
Ø15mm		Ø20mm	

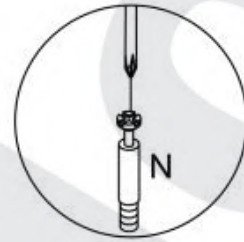
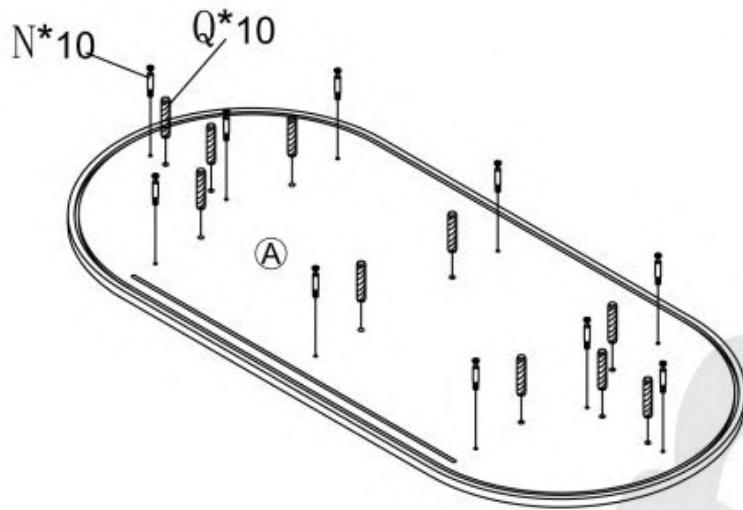

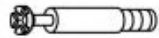
3:

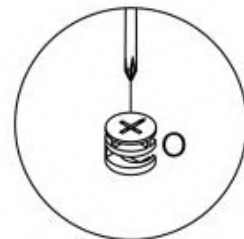
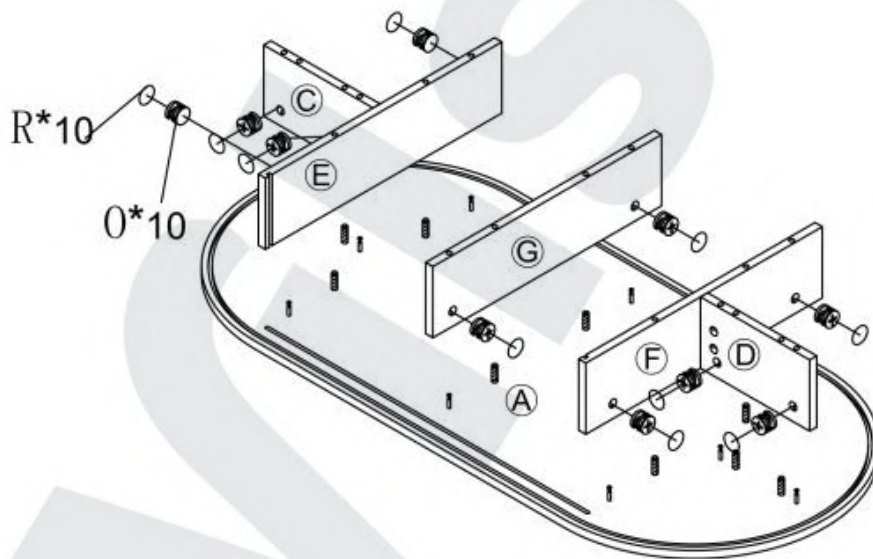

N	X10	Q	X10
			
M6*35mm		Ø8*30mm	

4:



O	X10	E	X10
			
Ø15mm		Ø20mm	

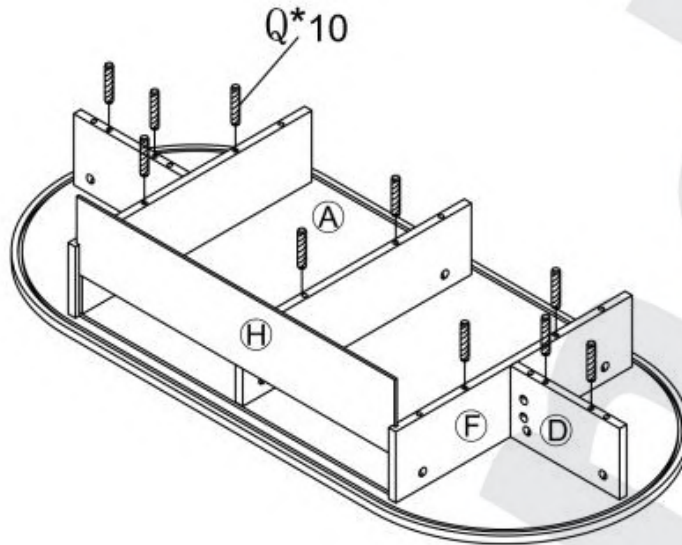

5:

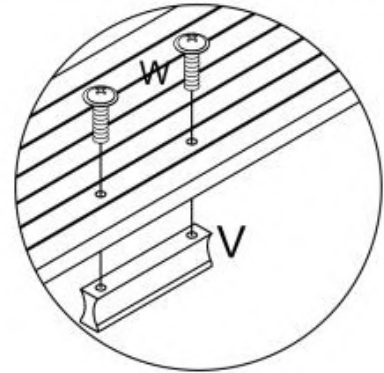
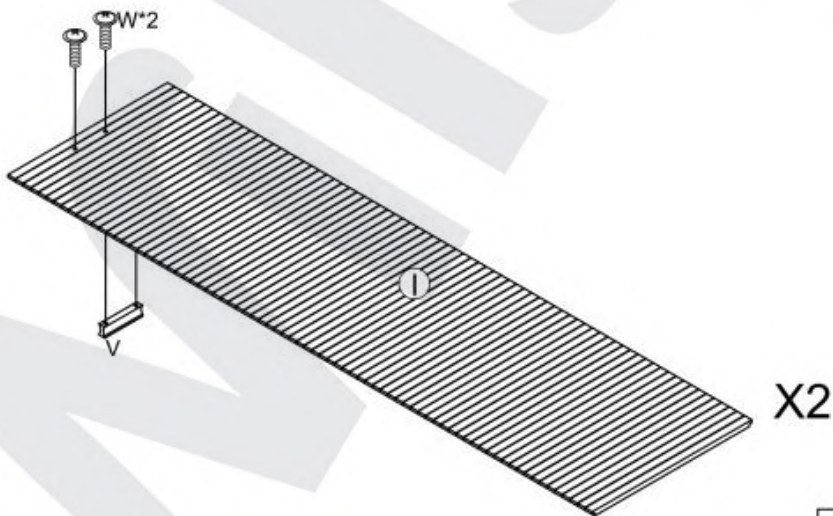

Q	X10
	
Ø8*30mm	

6:

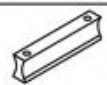

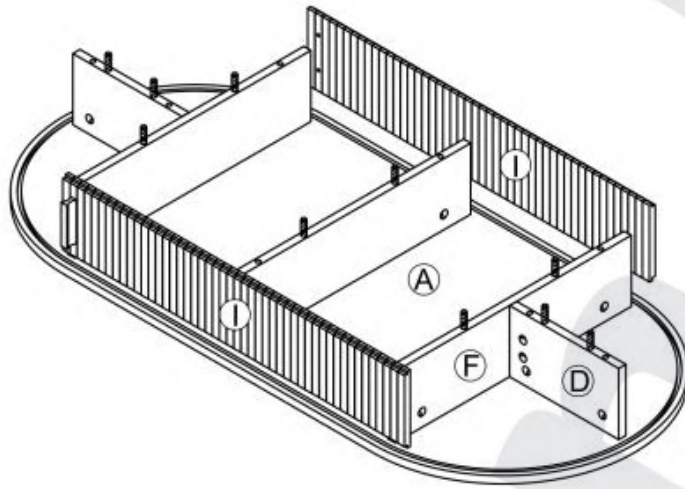

V	X2	W	X4
			
M4*8mm			

7:



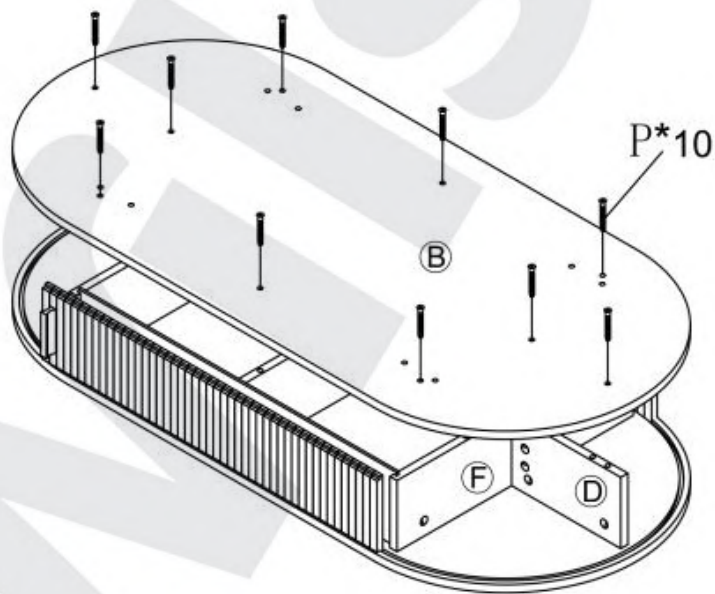
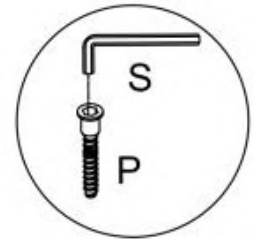



8:

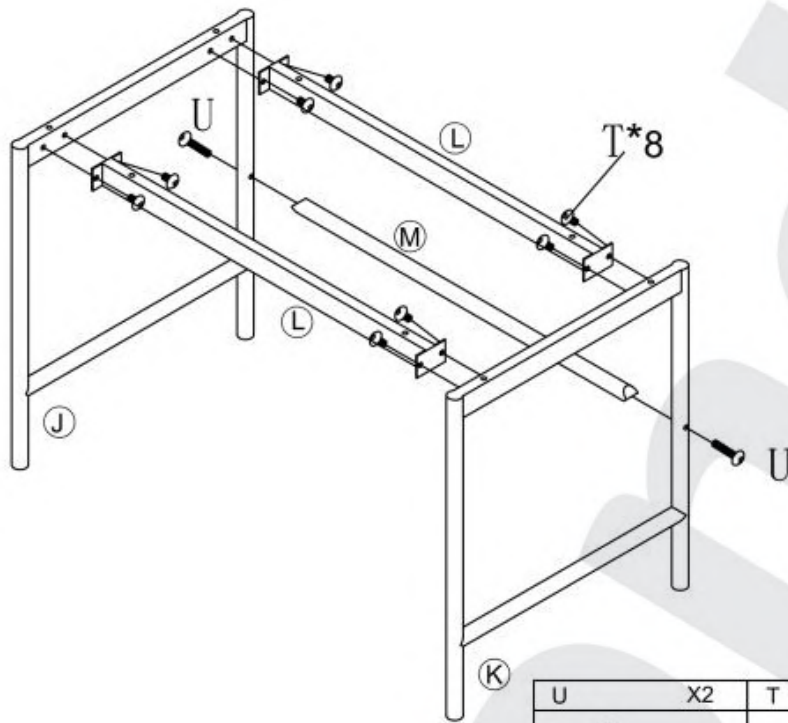

P	X10	S	X1
			
M7*50mm		M4	



9:

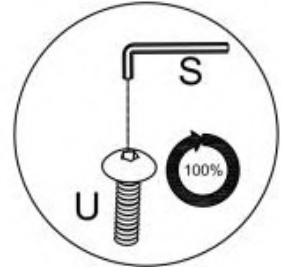
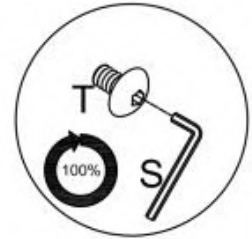
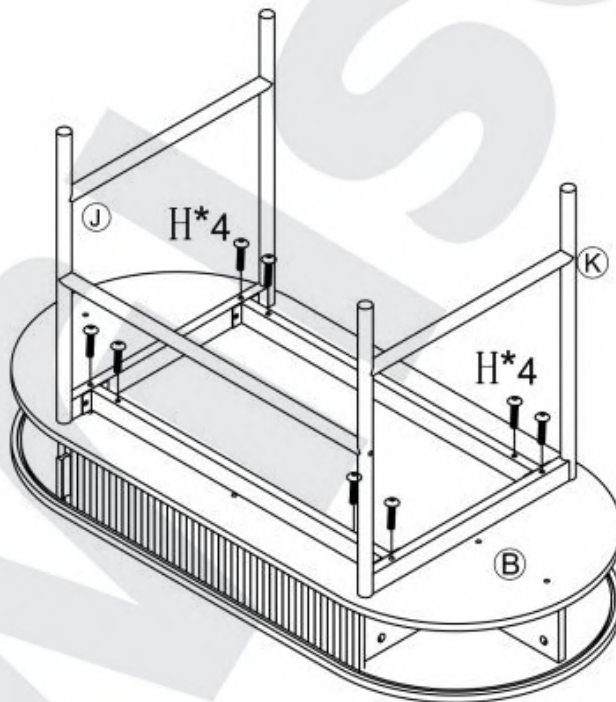

U	X2	T	X8	S	X1
					
M6*50mm		M6*12mm		M4	

10:



U	X8	S	X1
			
M6*50mm		M4	



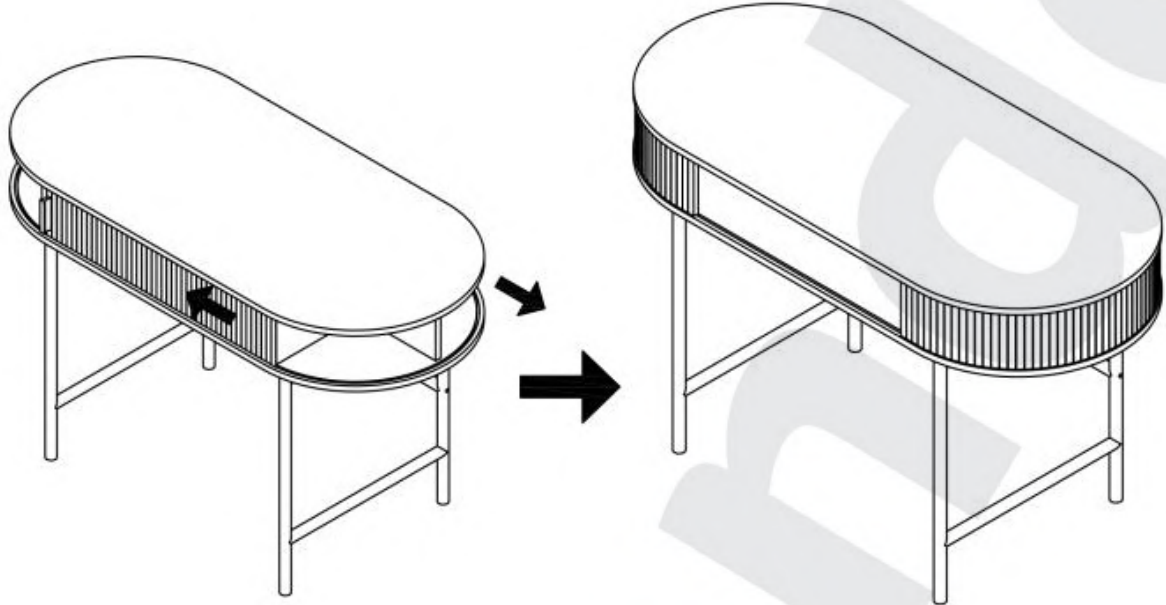

11:

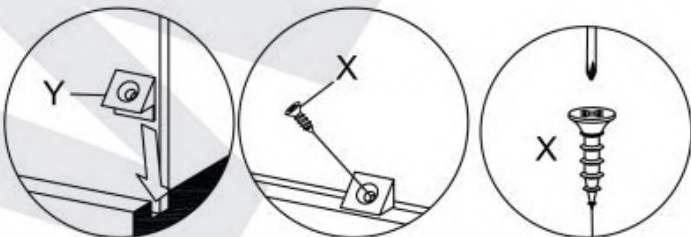
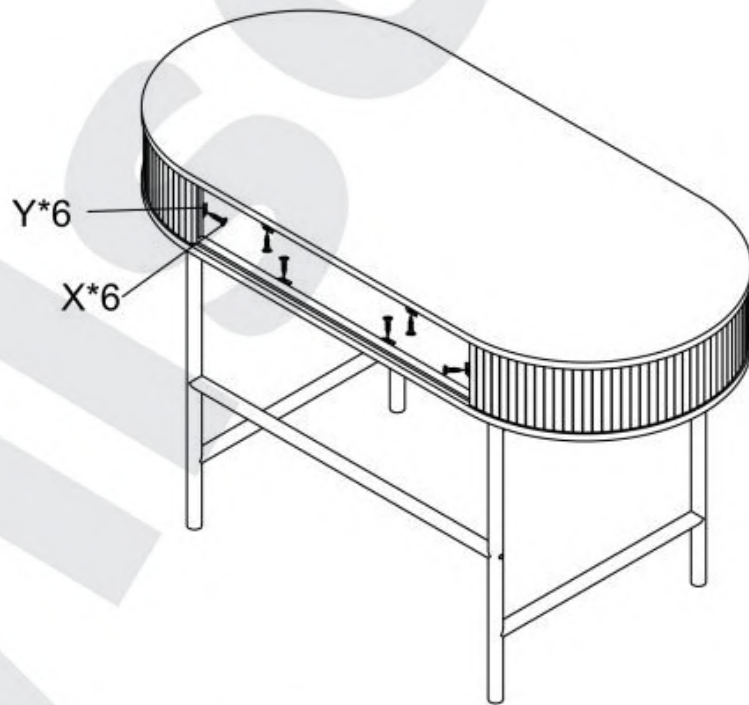

12:



X	X6	Y	X6
			
Ø3.5*14mm			