

50mm Screw x8

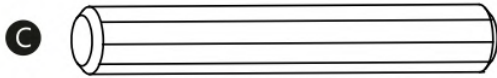

8x35 Wooden Dowel x20



8x60 Wooden Dowel x4



16mm Screw x2

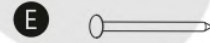

Panel pin x18

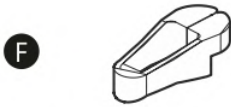

Panel pin locator x1



Cover cap x8

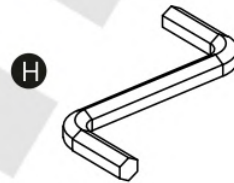

Key x1

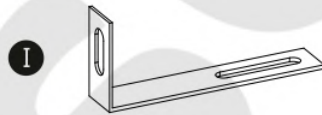

Wall Fixing Bracket x1

Tools required

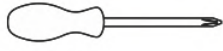

Phillips screwdriver
(small & medium)



Flat screwdriver
(small & medium)

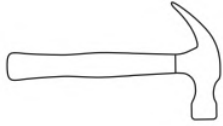

Hammer



Pencil

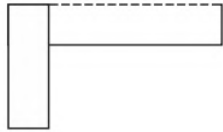

Set Square

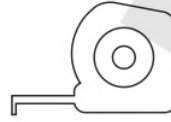

Ruler/tape
measure



Eye protection
(when using a
hammer or glue)

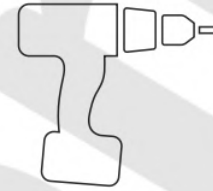

Power Drill

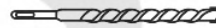

Drill Bits



Spirit Level

Panels

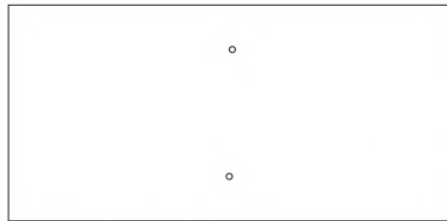

(Side View)

1 Top / Bottom Panel (580 x 293mm) (x2)



2 Side Panel (912 x 295mm) (x2)

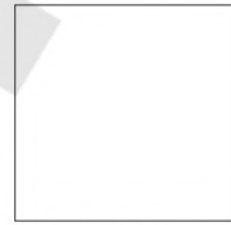

3 Divider (282 x 291mm) (x3)



(Side View)

4 Shelf Panel (580 x 293mm) (x2)



5 Back Panel (308 x 295mm) (x3)

1

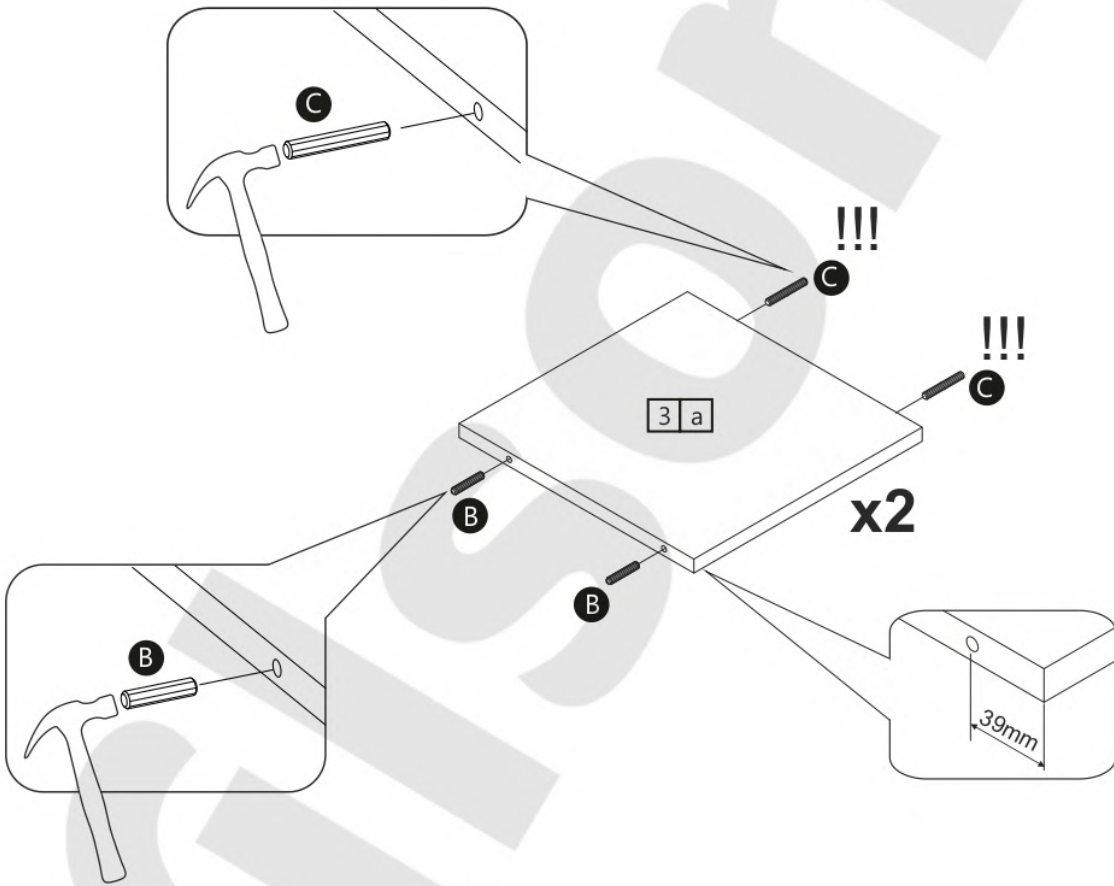
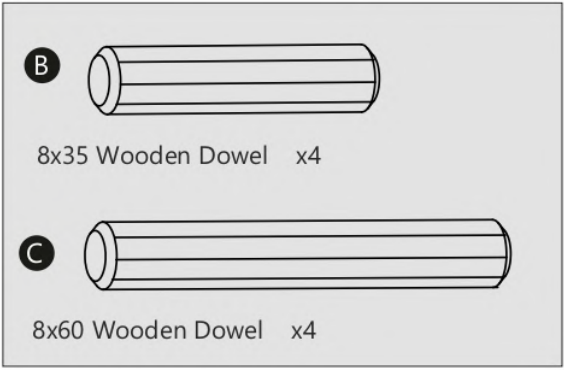

2

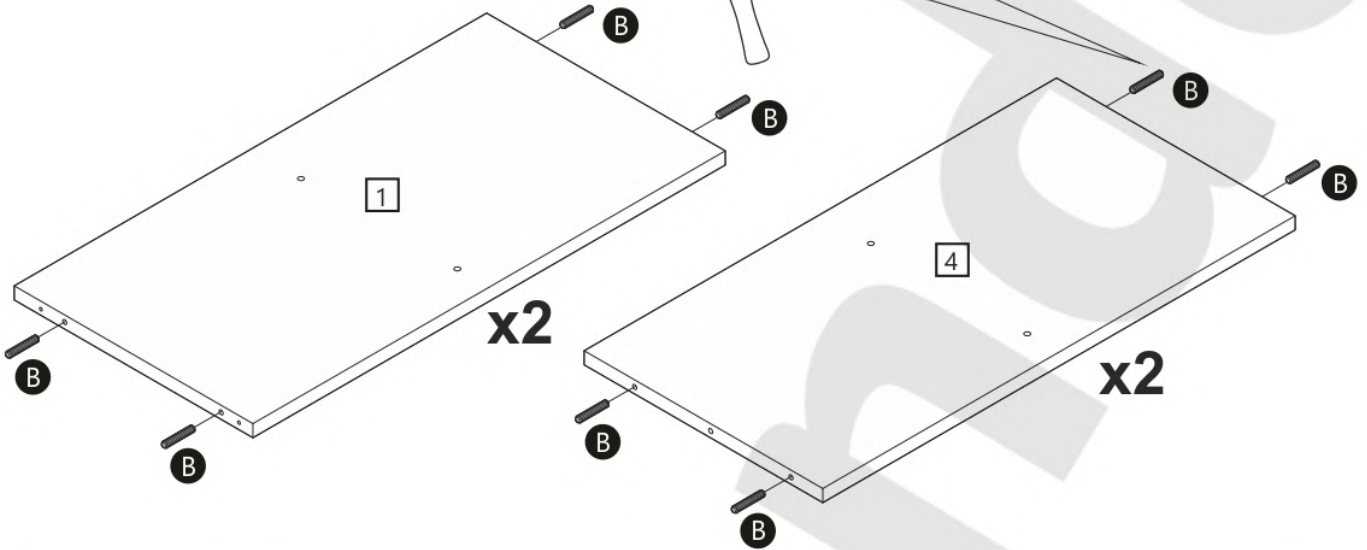
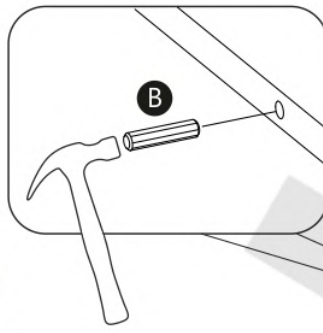
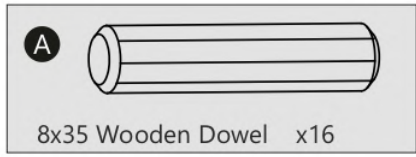

3

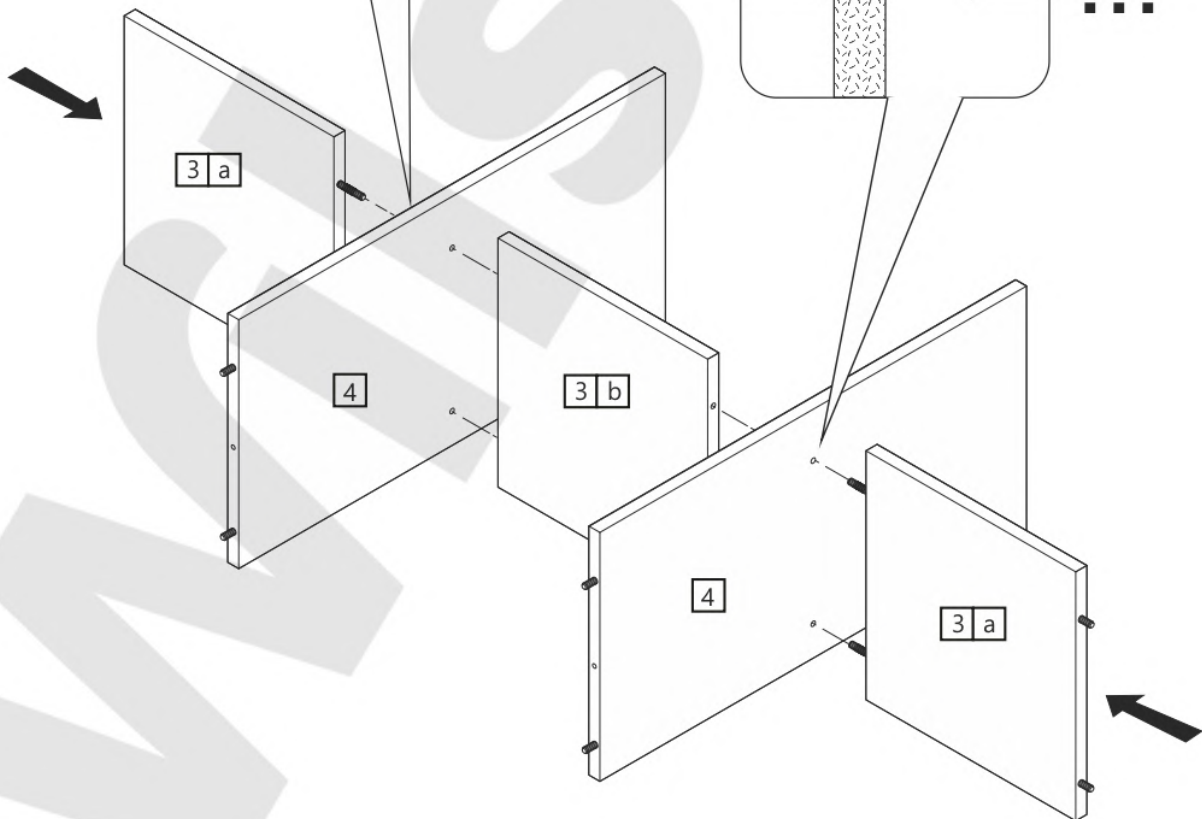
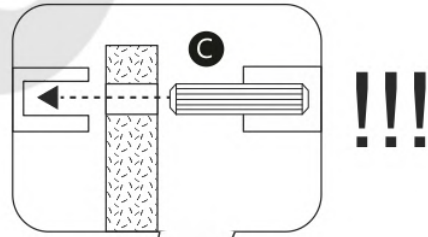
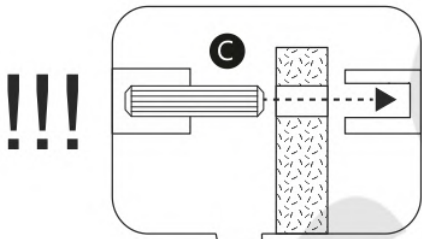

4

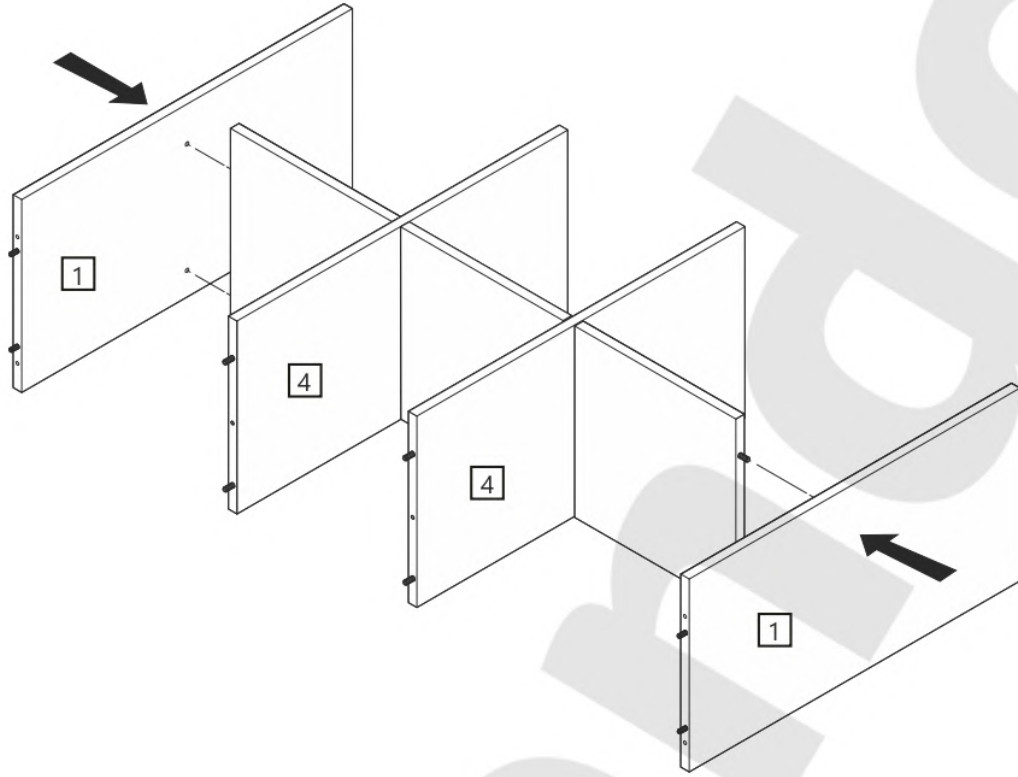

5

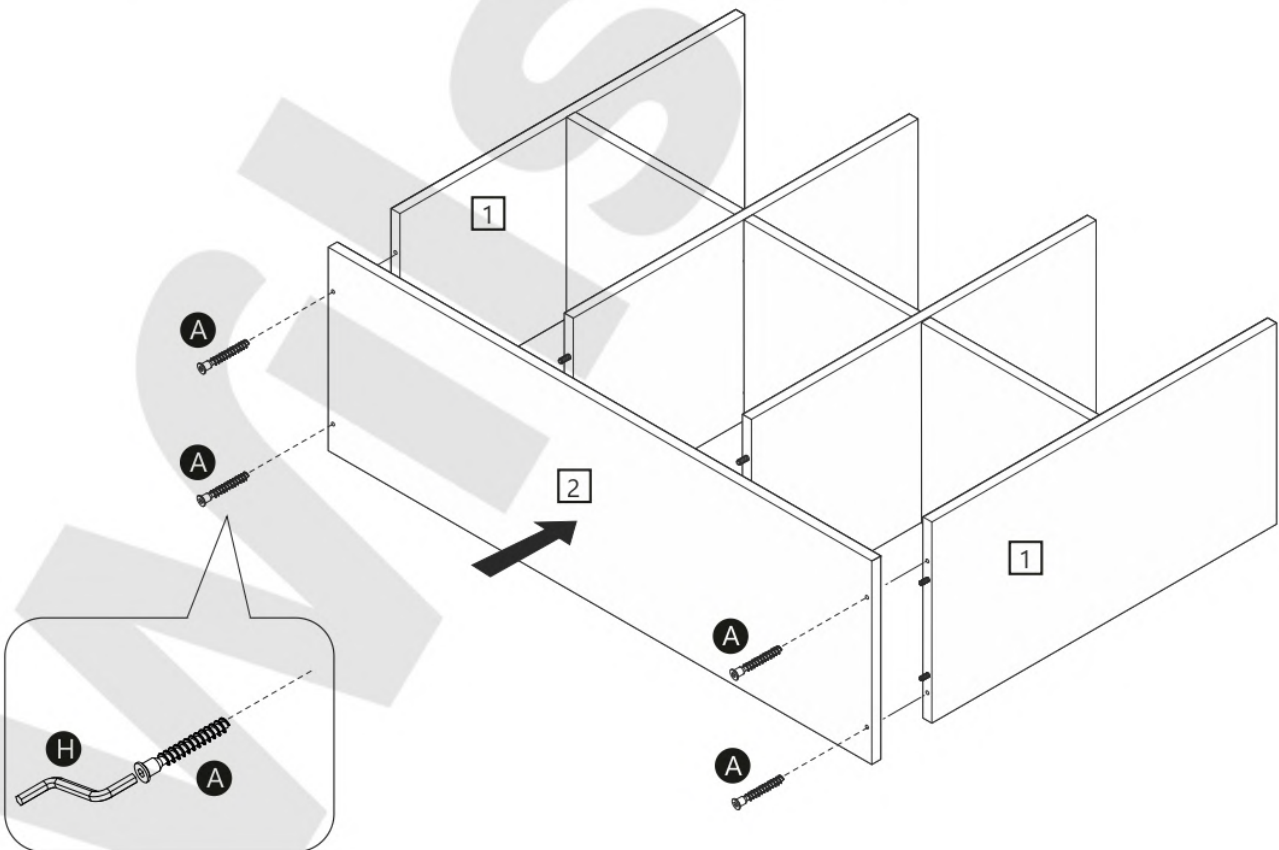
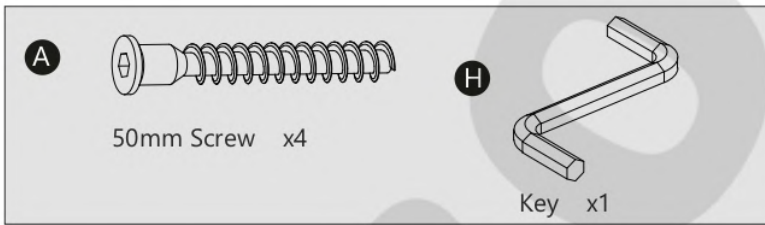

6

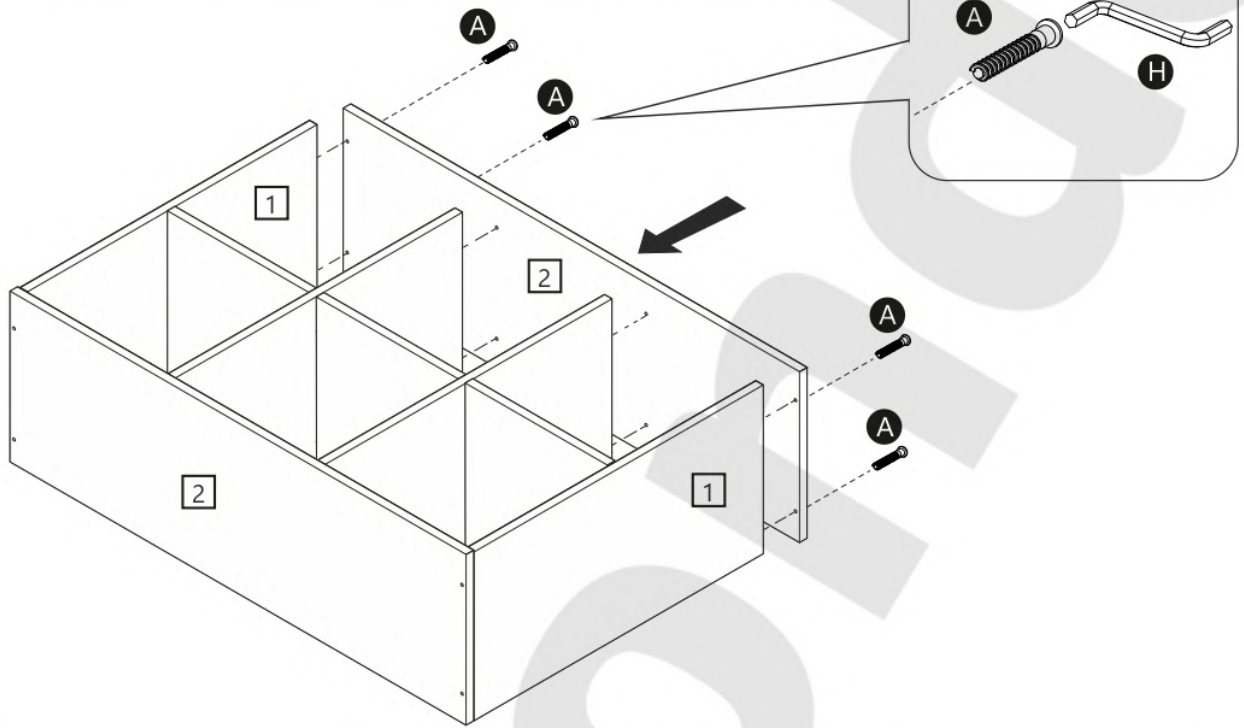
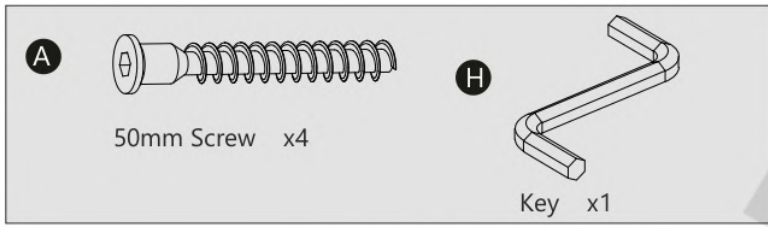

7

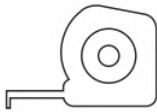

$A=B$

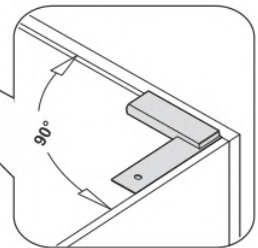
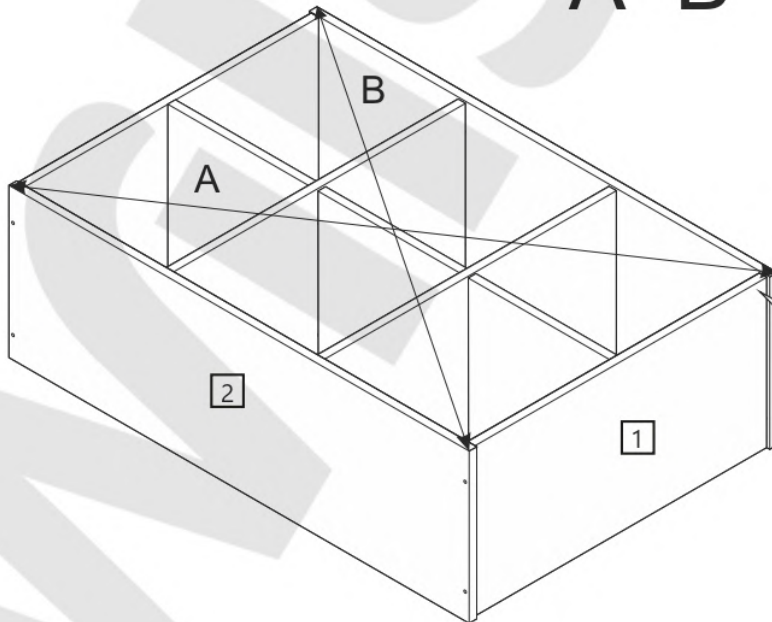
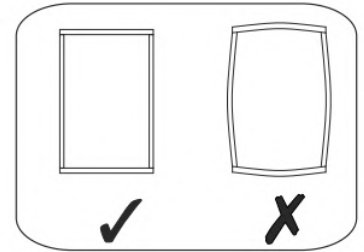

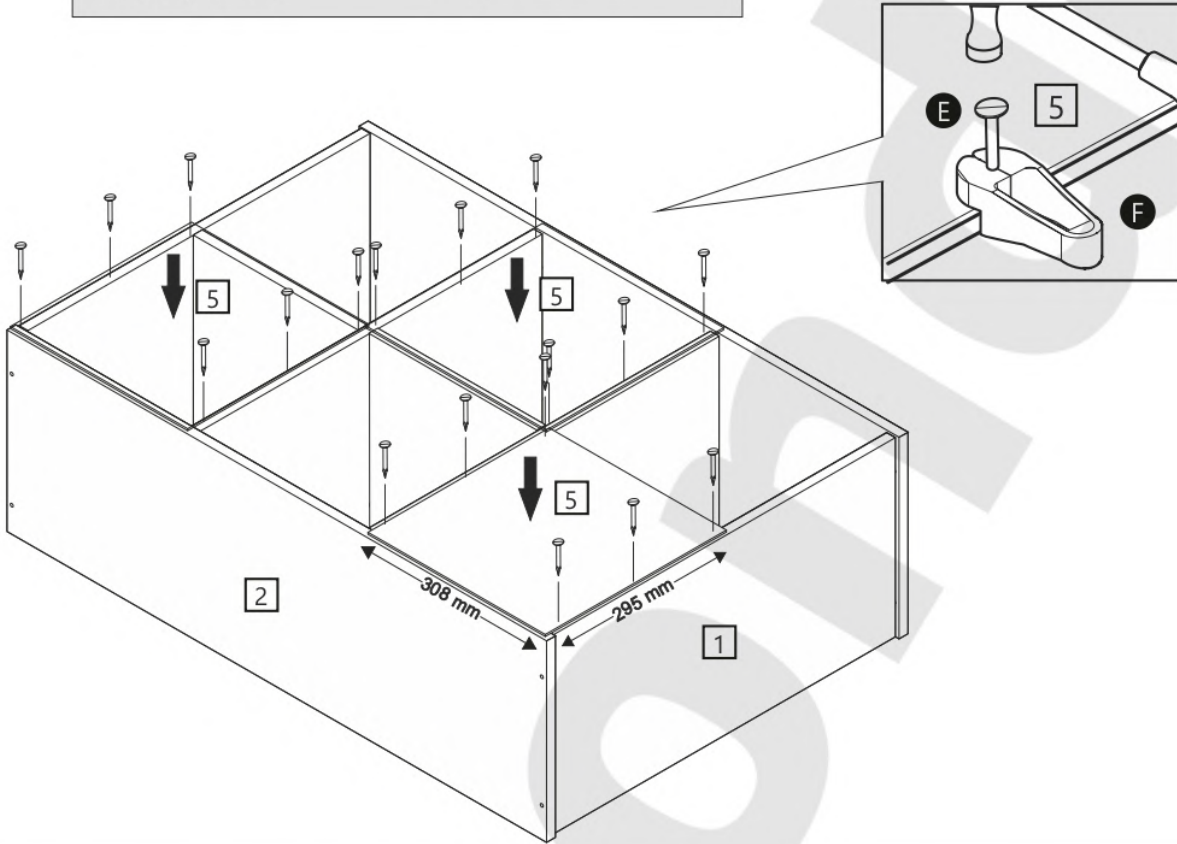
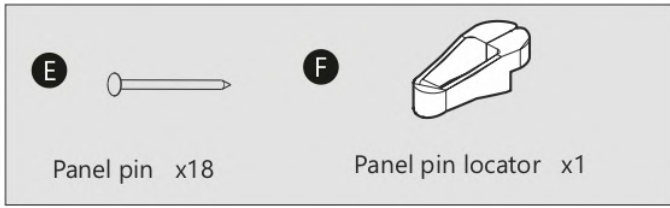

8

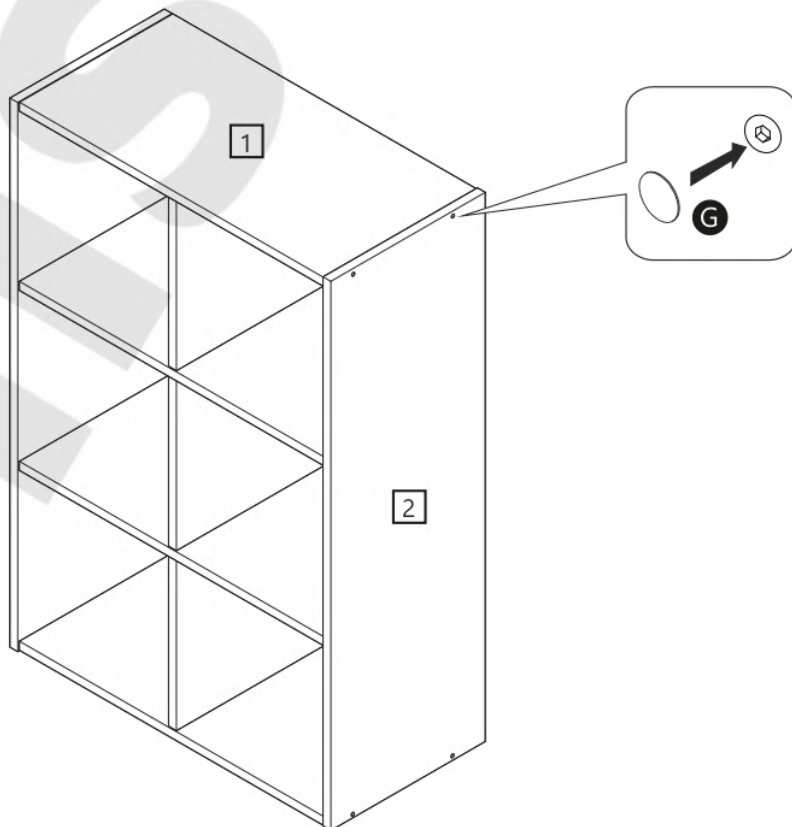

9

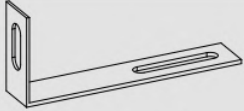

10

I 	D 
Wall Fixing Bracket x1	16mm Screw x2

