

A 50mm Screw x10

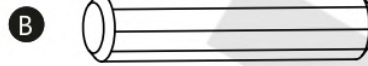

B 8x35 Wooden Dowel x16

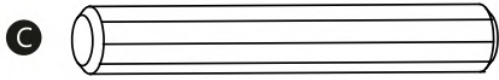

C 8x60 Wooden Dowel x6



D 12mm Screw x4



E Panel pin x24



F Panel pin locator x1



G Cover cap x10

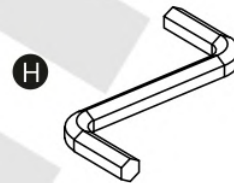

H Key x1

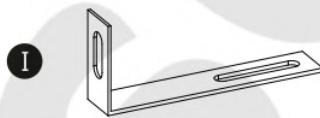

I Wall Fixing Bracket x2

Tools required



Large Cross
Headed
Screwdriver

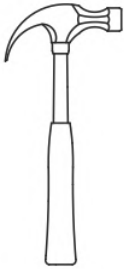

Small Hammer

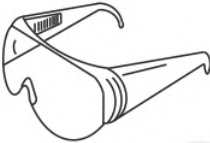

Eye protection
(when using a
hammer)

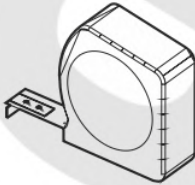

Tape Measure

Panels

Storage unit

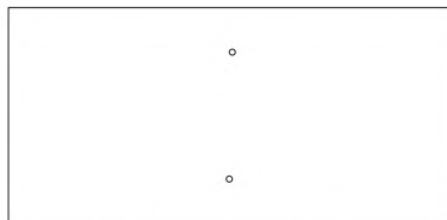

(Side View)

1 Top / Bottom Panel (580 x 293mm) (x2)



2 Side Panel (1208 x 295mm) (x2)



3 Divider (282 x 291mm) (x4)



5 Back Panel (308 x 295mm) (x4)

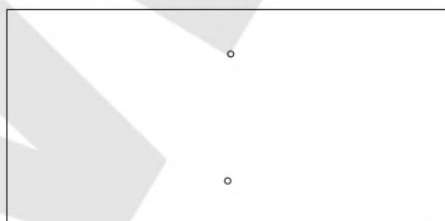

(Side View)

4 Shelf Panel (580 x 293mm) (x3)

2

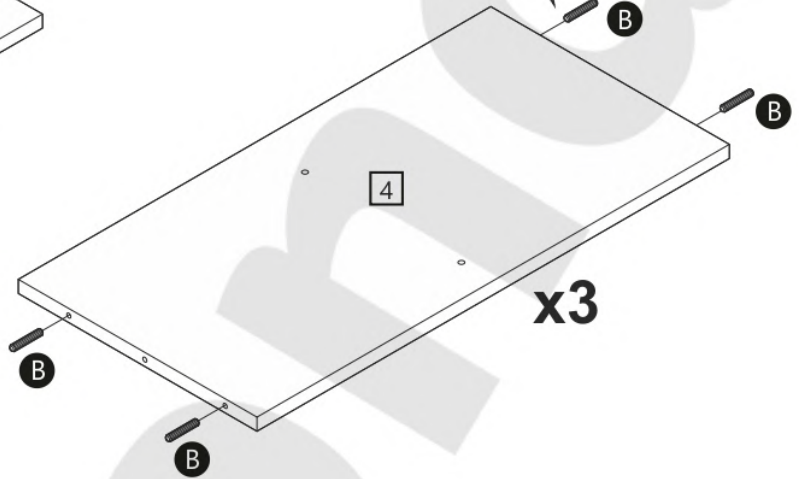
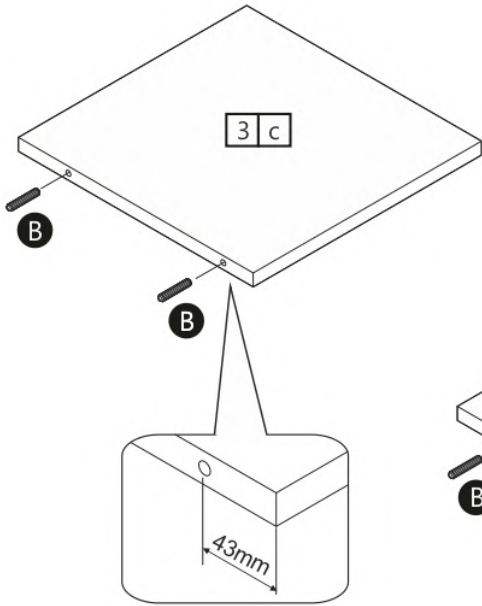
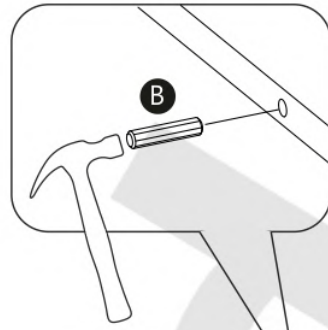
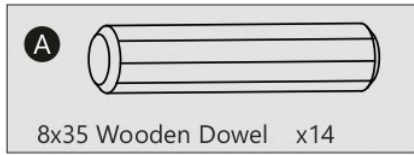

3

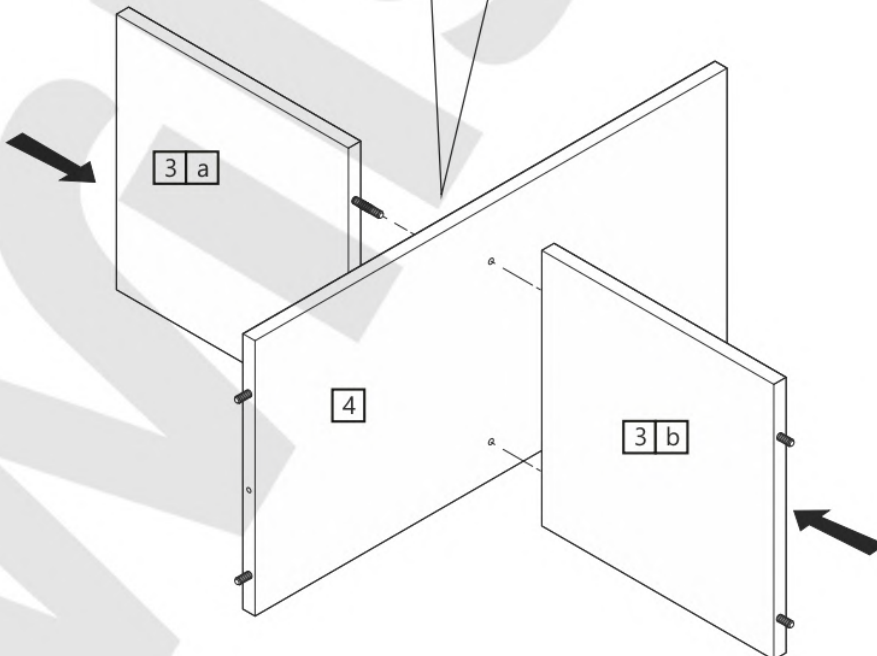
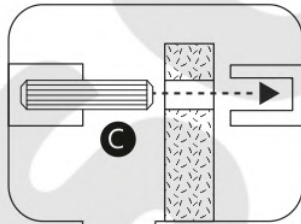

4

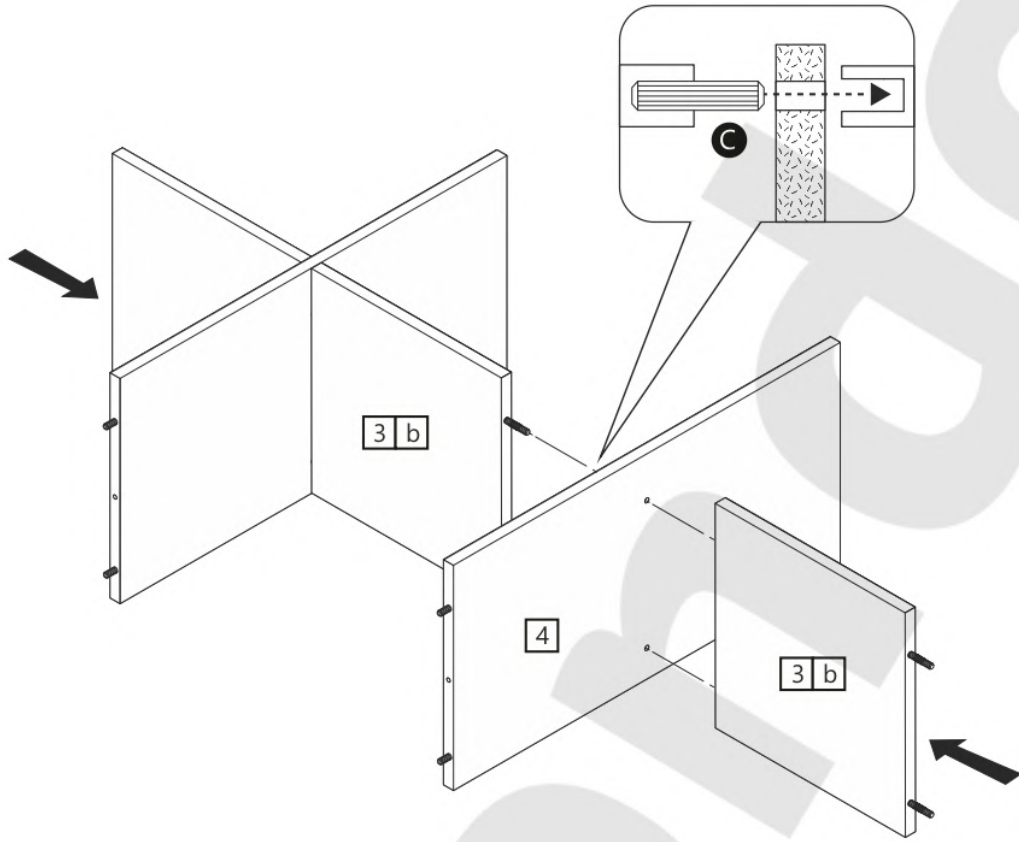

5

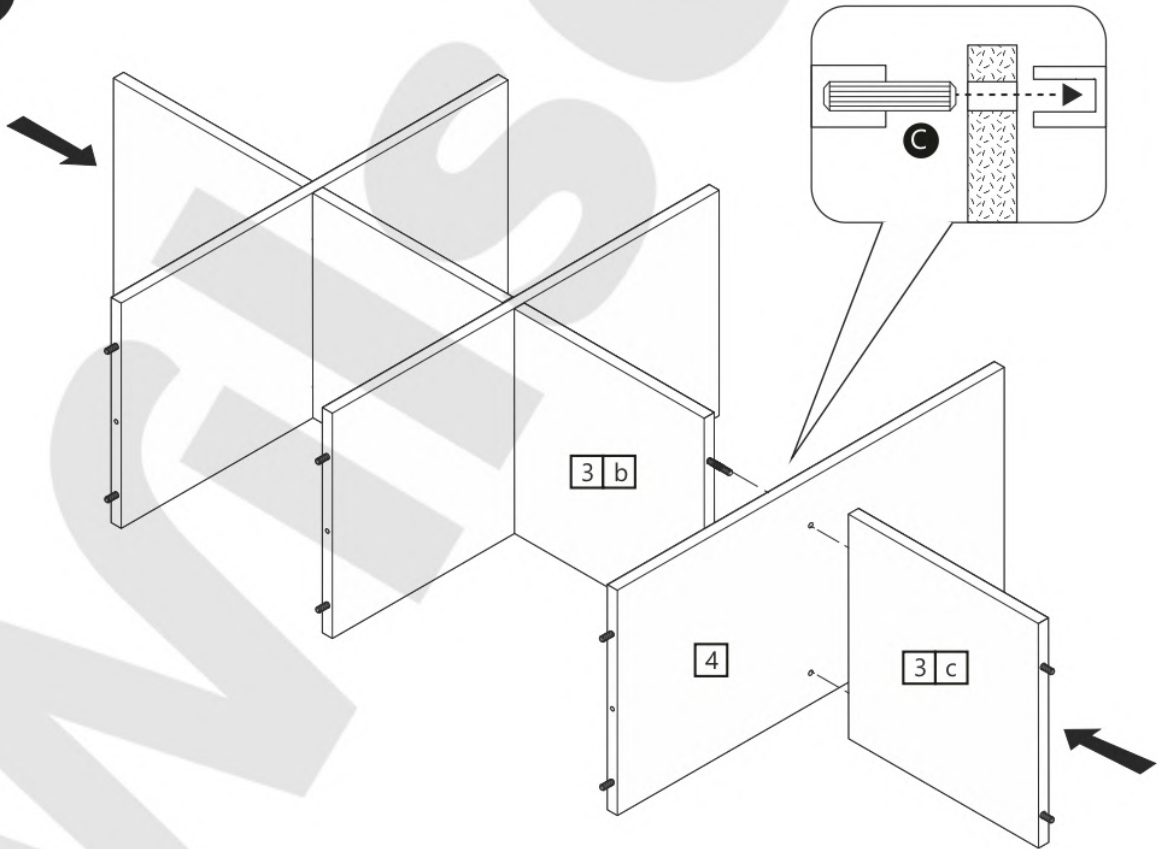

6

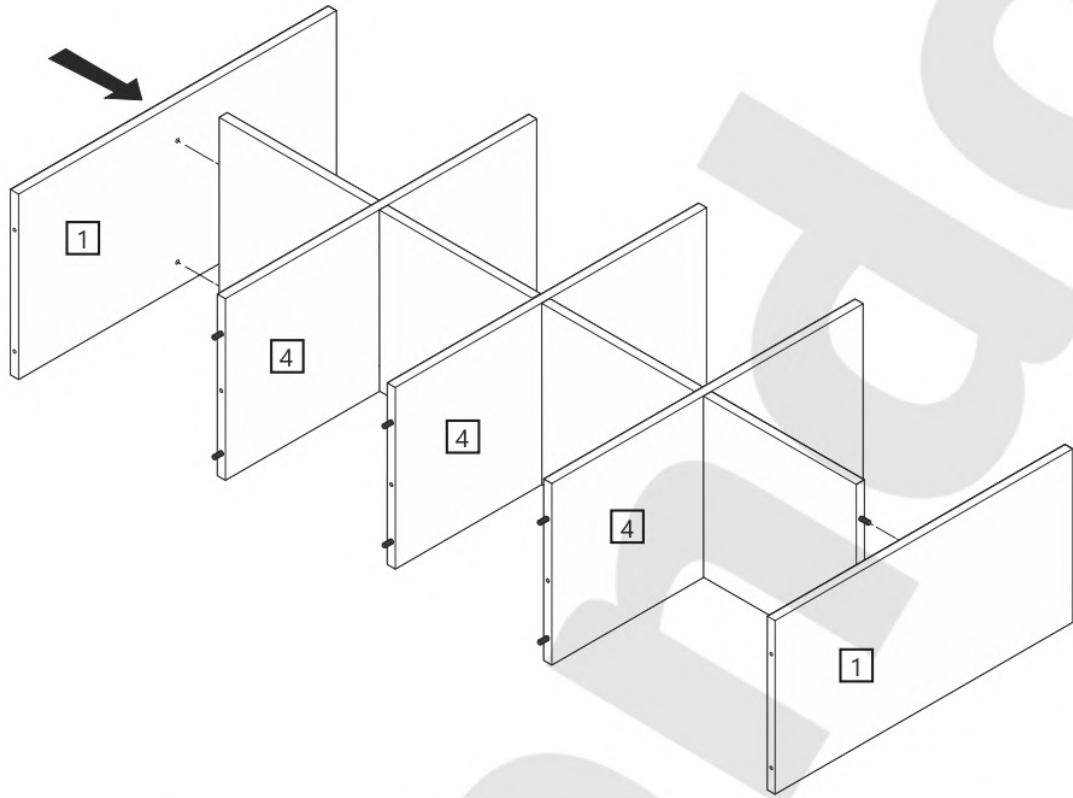

7

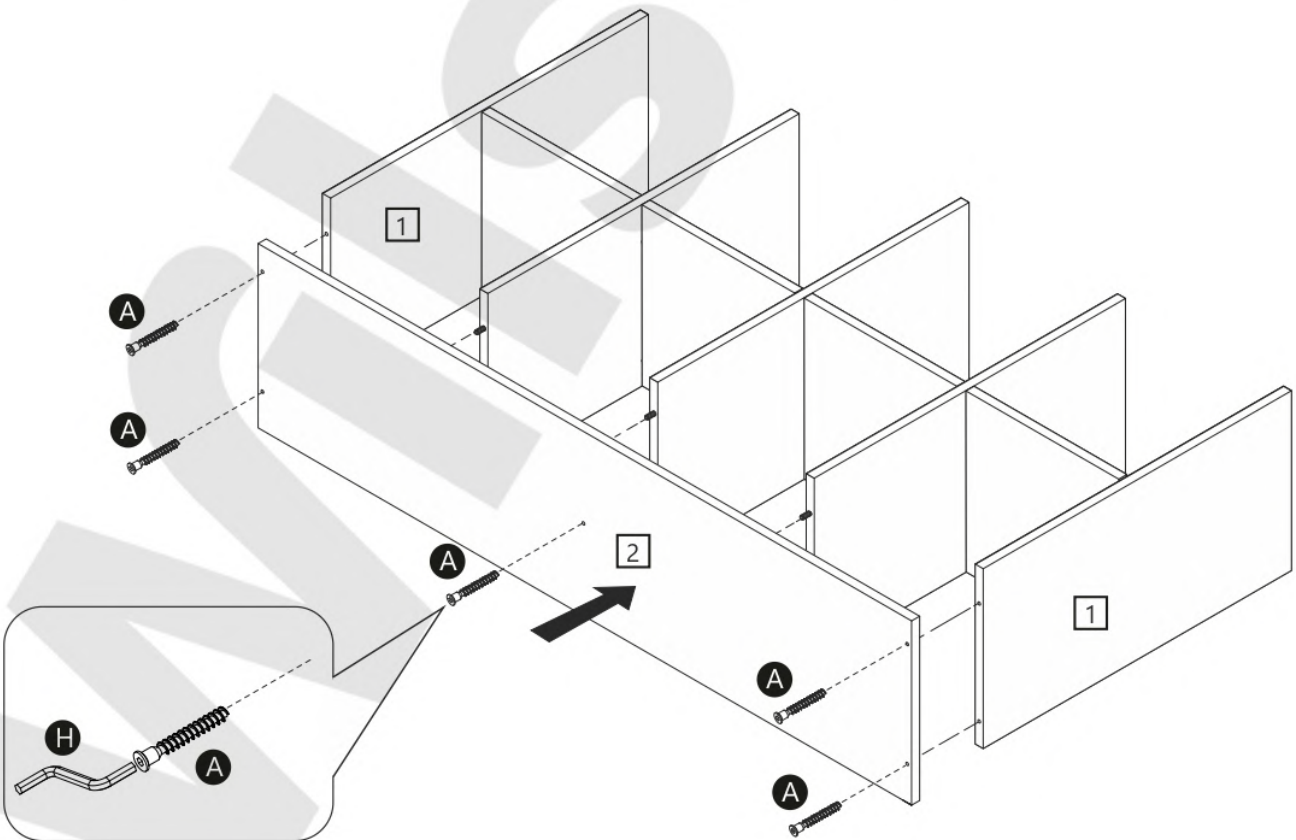
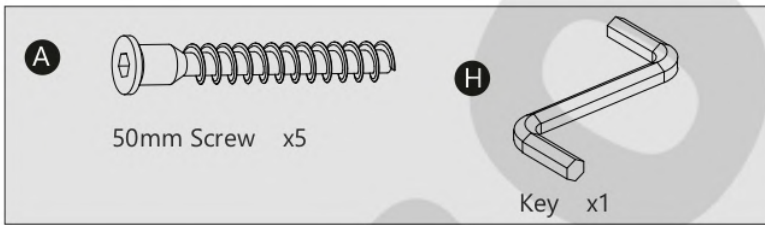

8

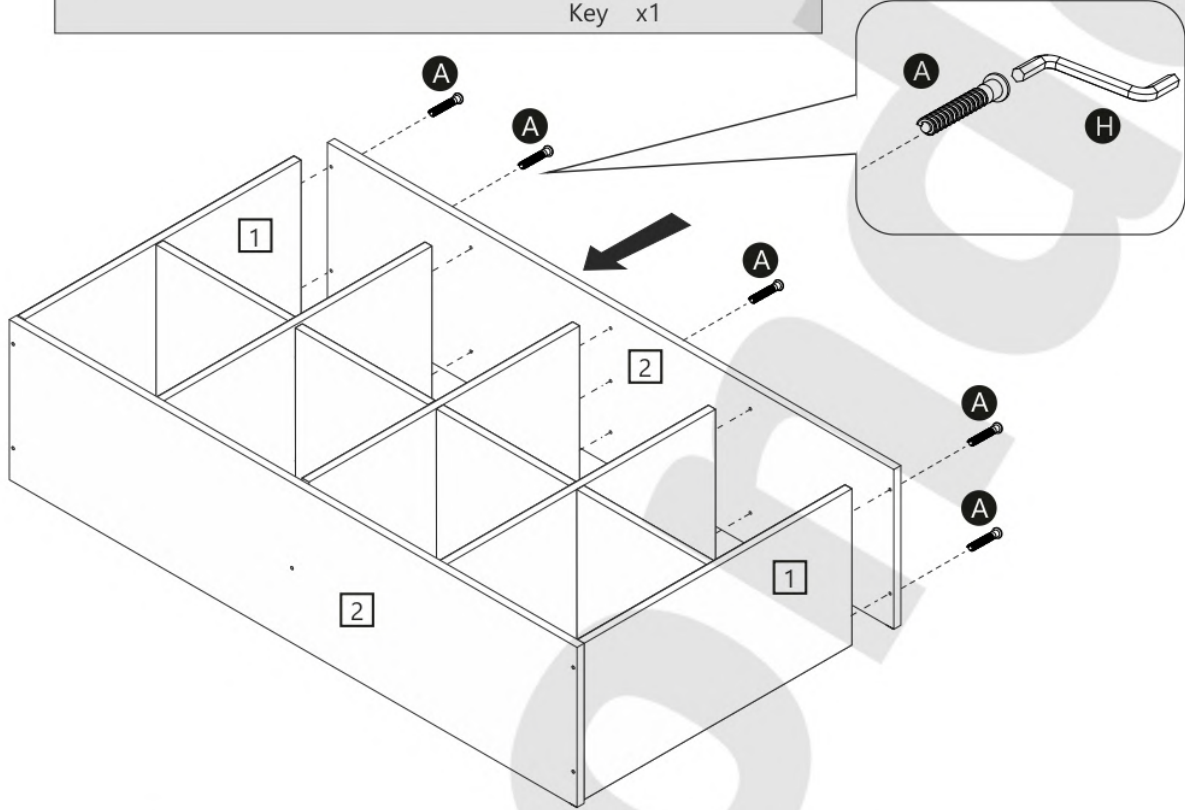
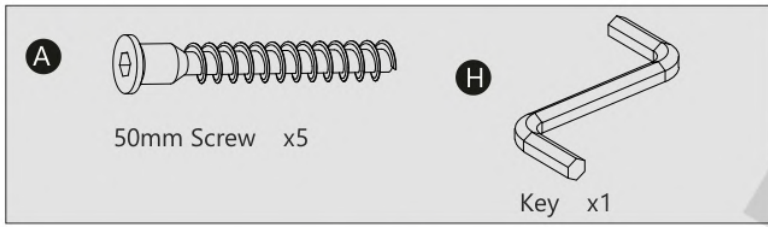

9

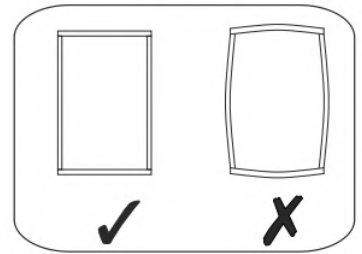
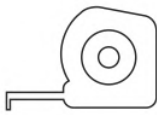

$A=B$

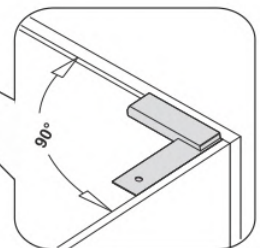
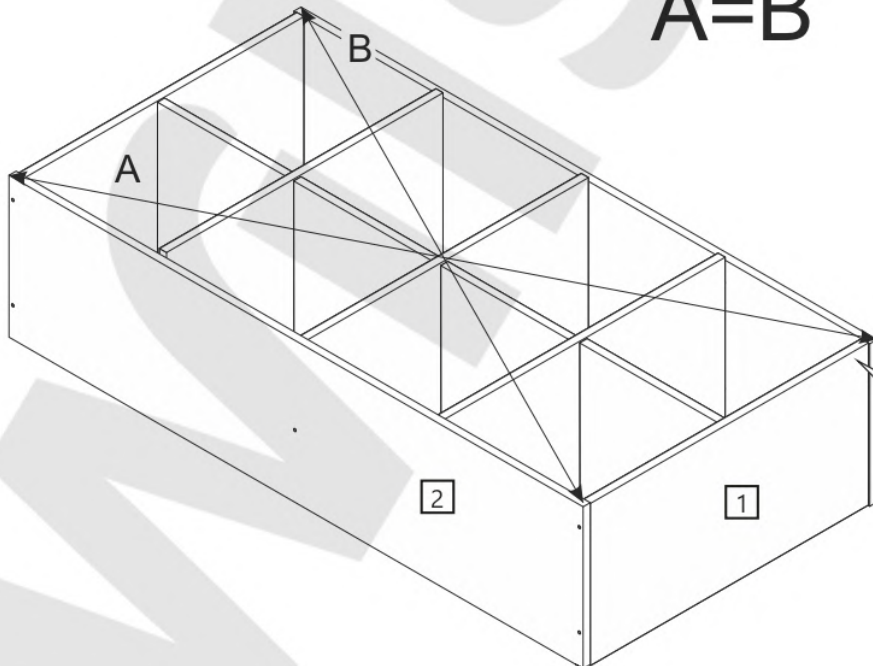

10

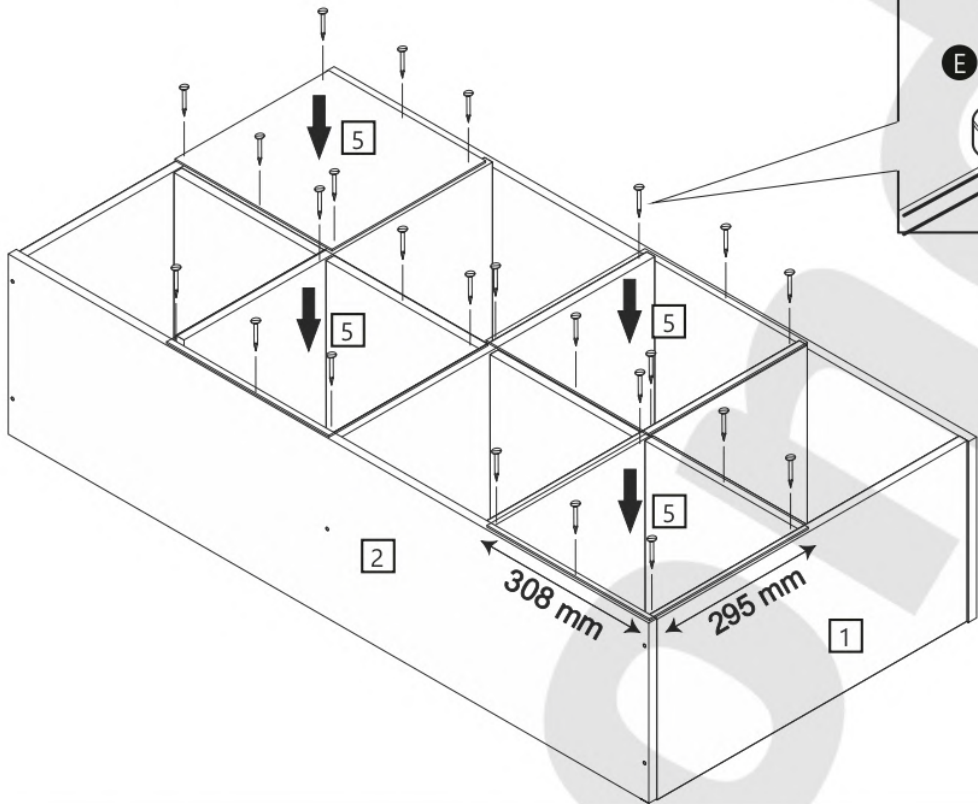
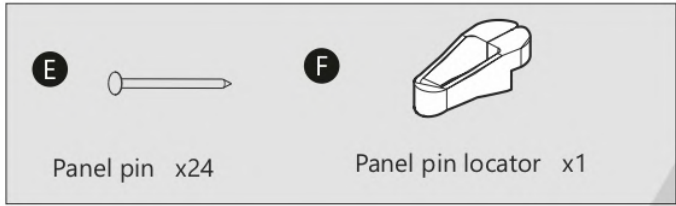

11

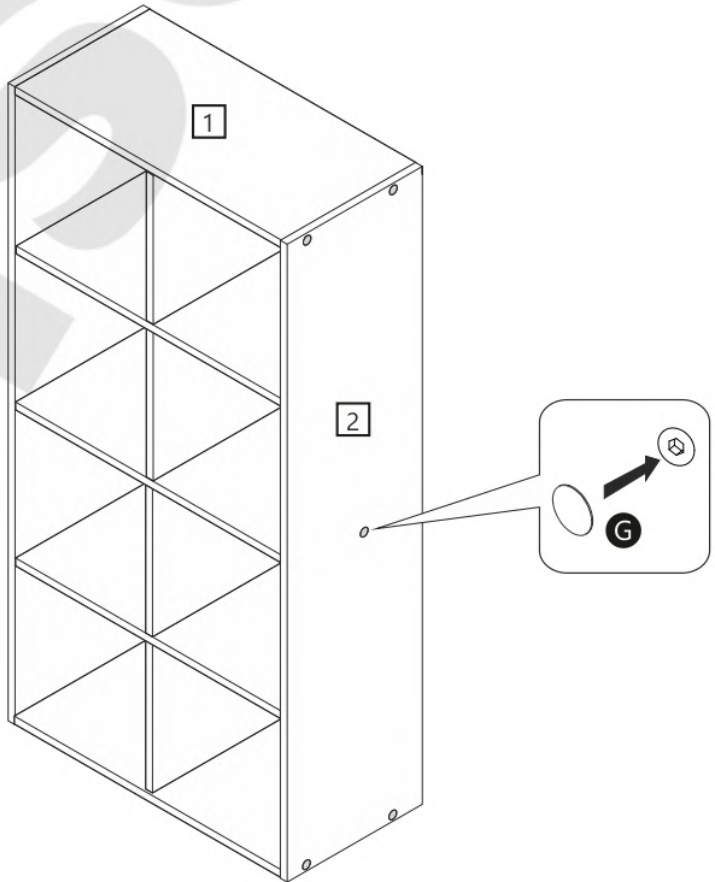

12

