

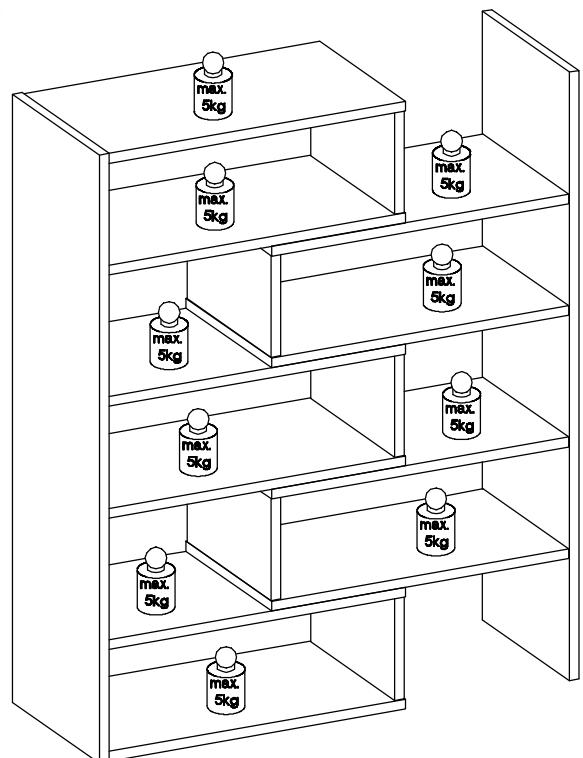

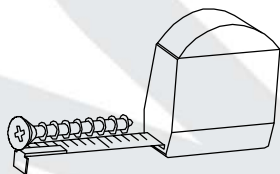

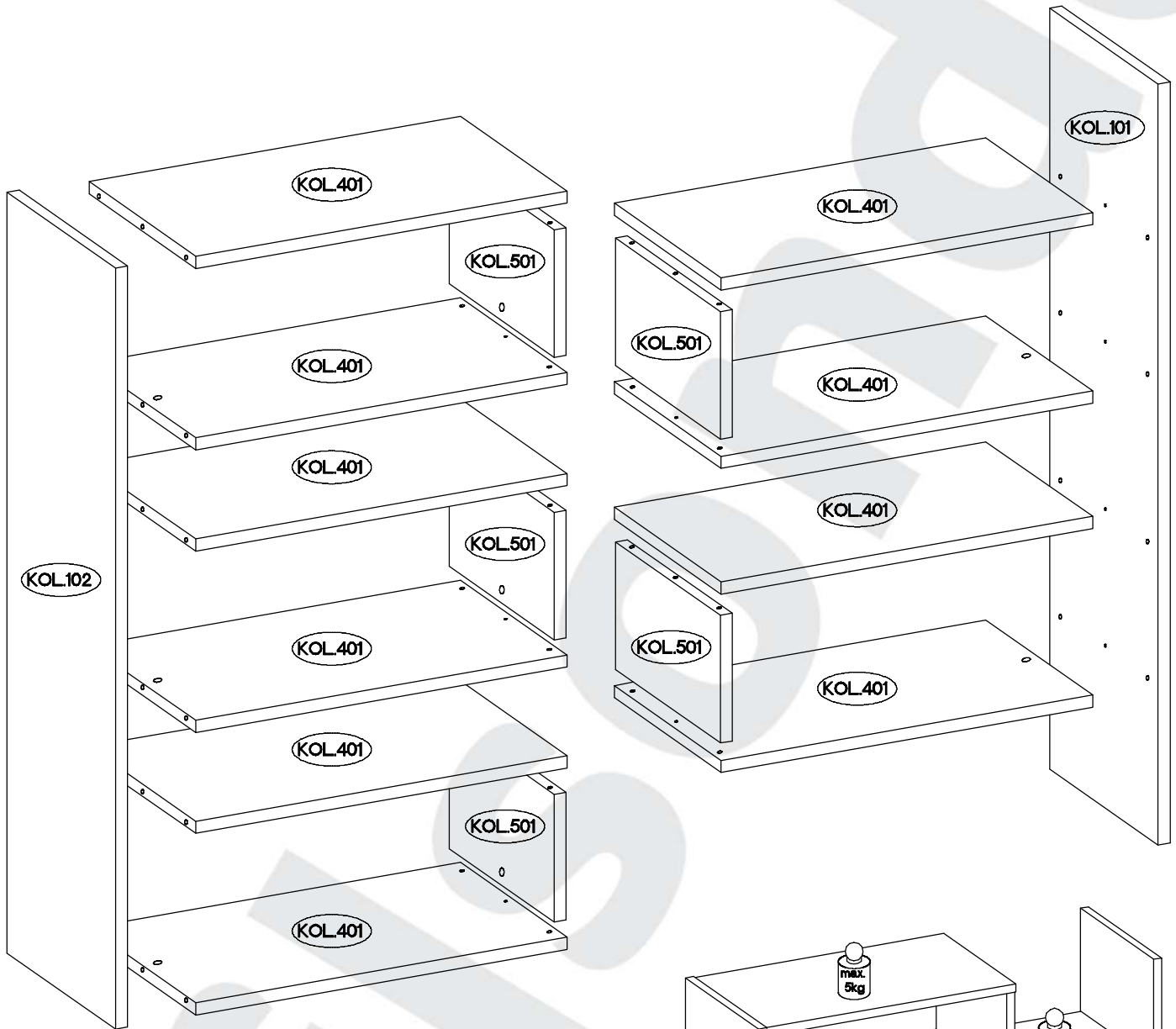

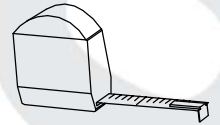

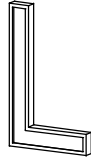
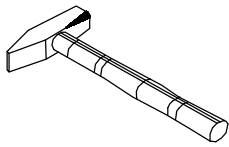
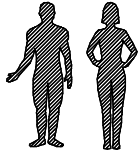

Regał KAROL



 4x30mm A 40	 L=20mm D2 20	 45/12mm C 20	 45x5mm F4 6	 E 20	 0,05 O11 1
--	--	--	---	---	--

1.

 $\pm 8 \times 30 \text{ mm}$ A	 L-20mm D2	 $\pm 15/12 \text{ mm}$ C	 0,05 O11
40	20	20	1

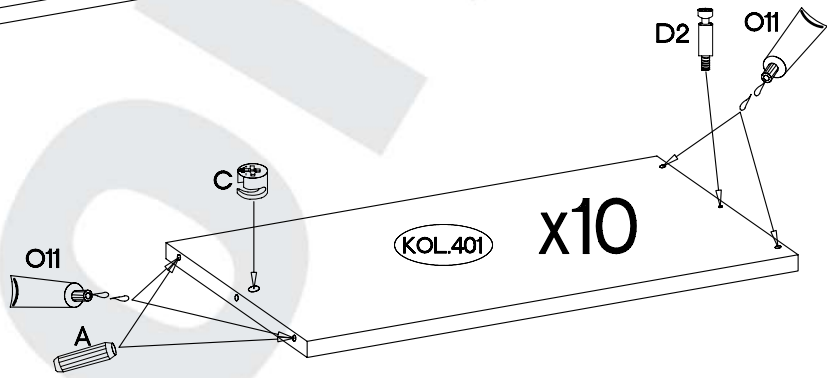
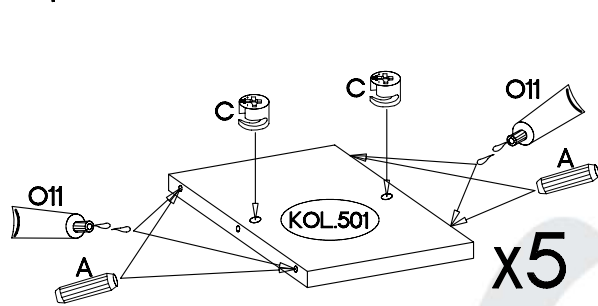
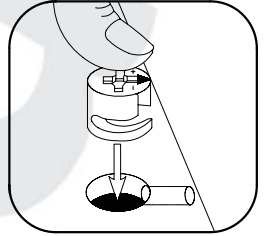
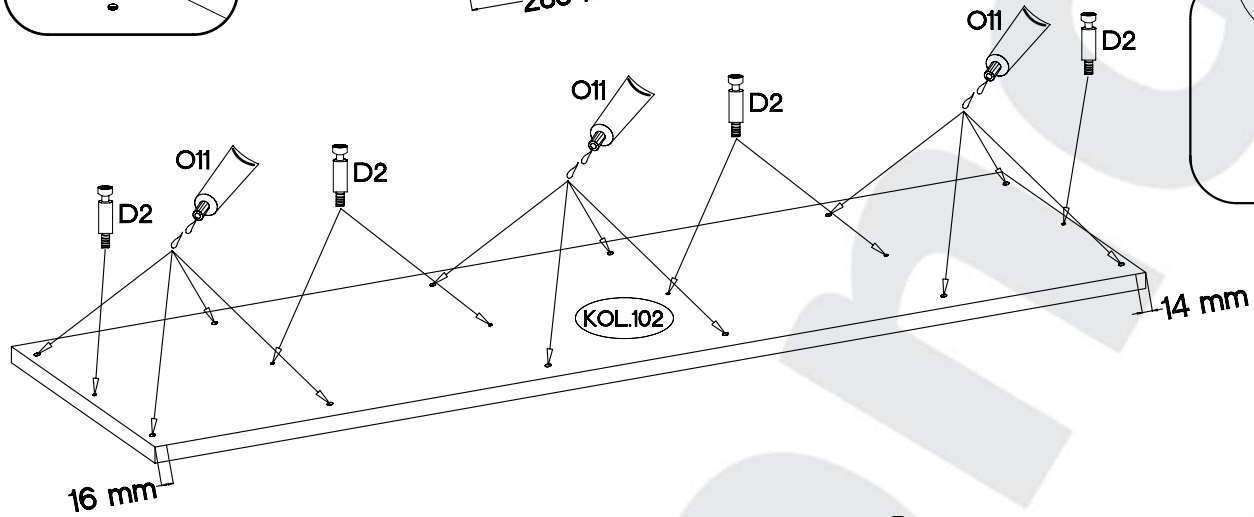
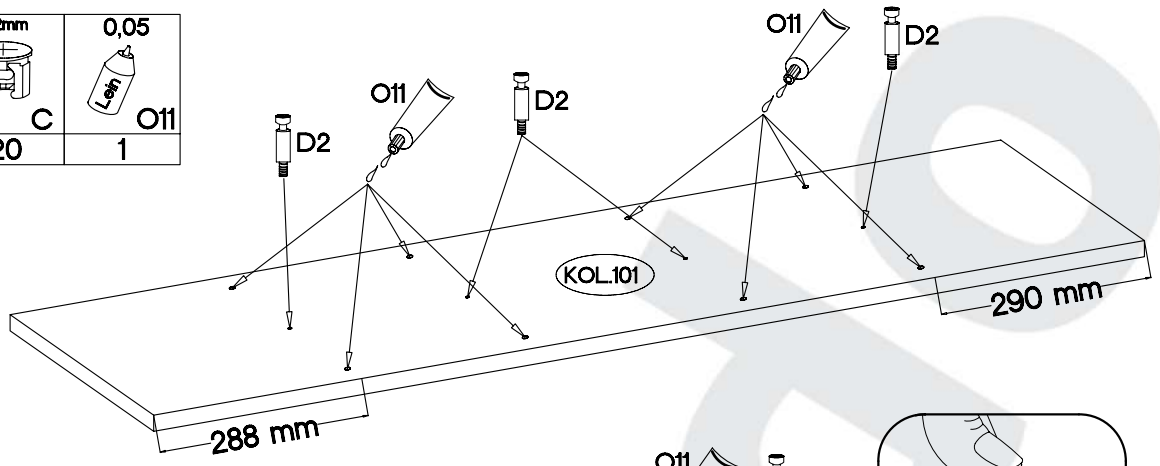
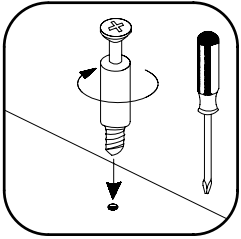

2.

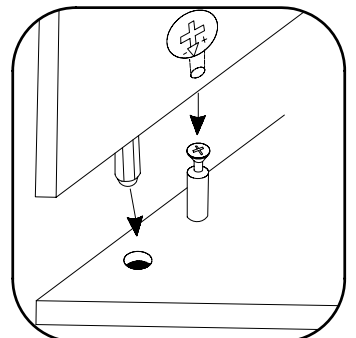
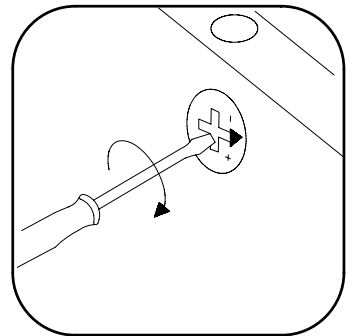
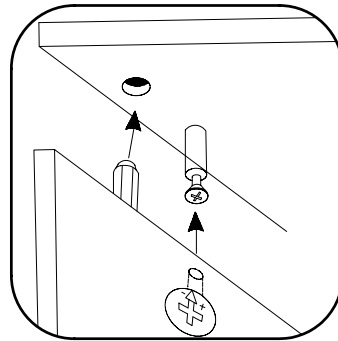
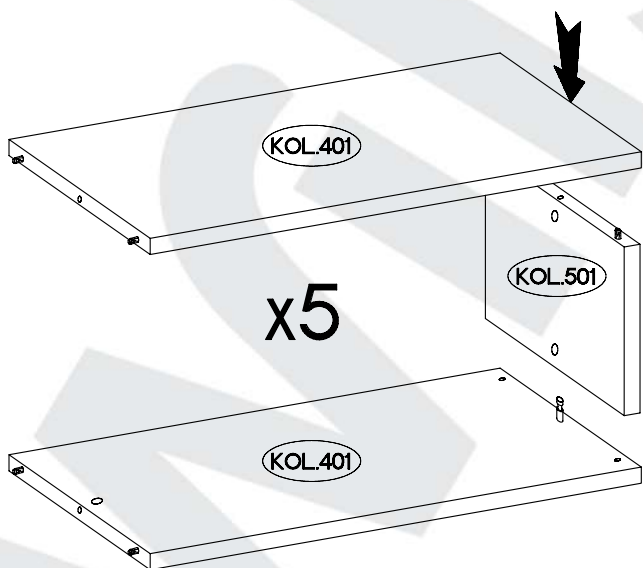

3.

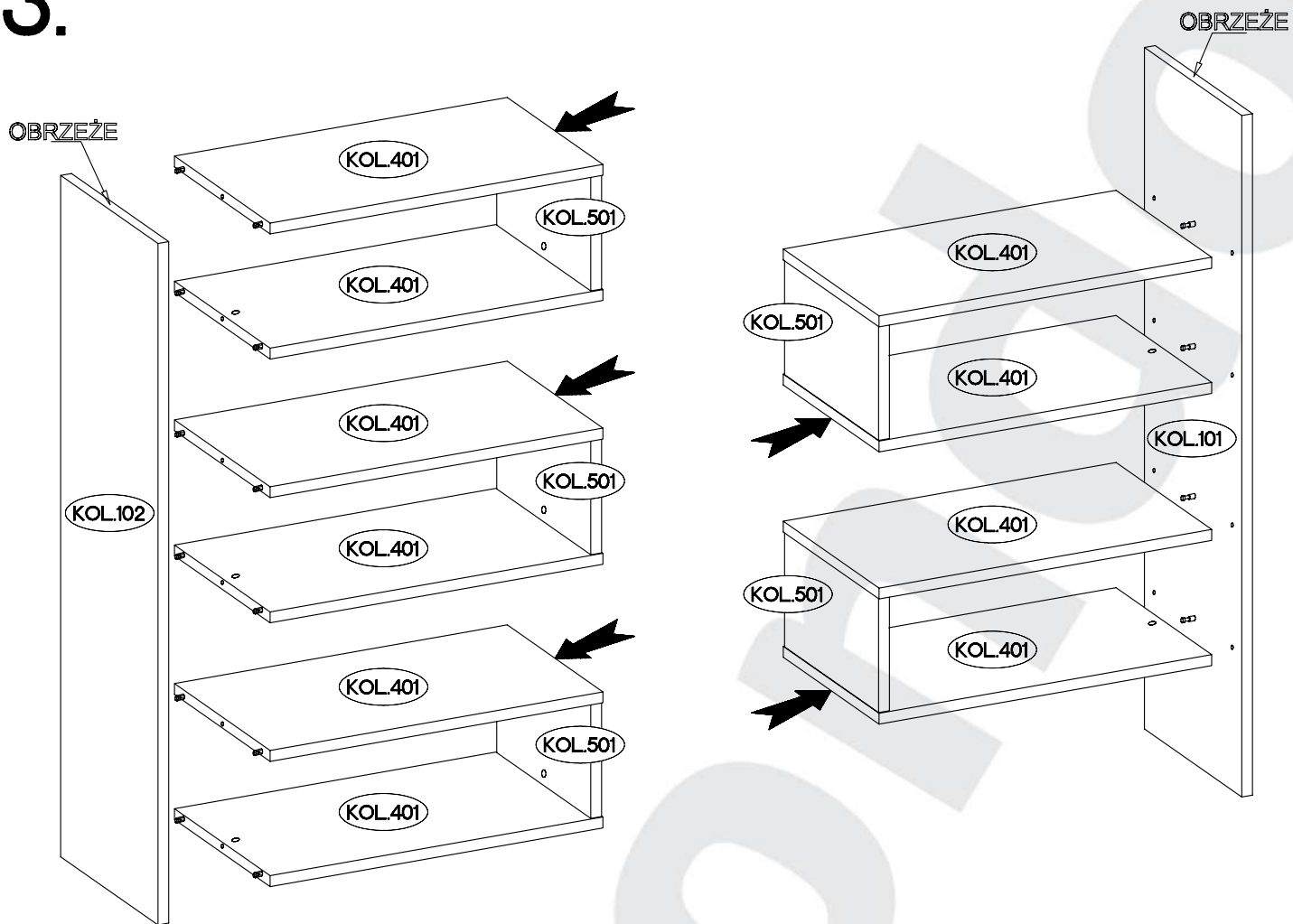

4.

±15x5mm	
F4	E
6	20

