

LANDRO LR-10

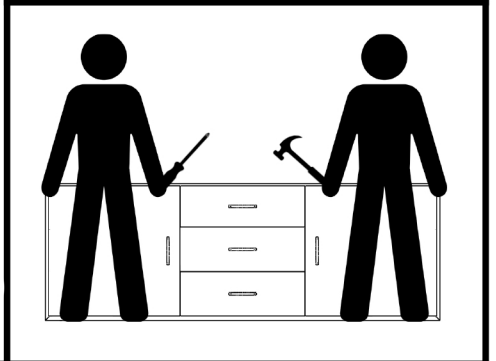

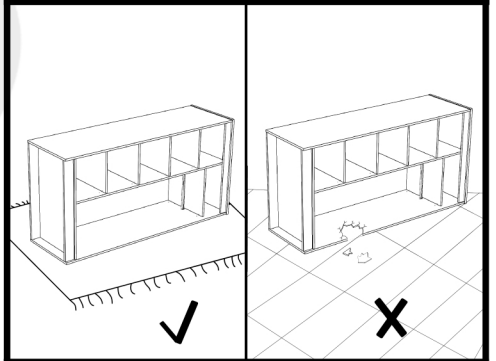
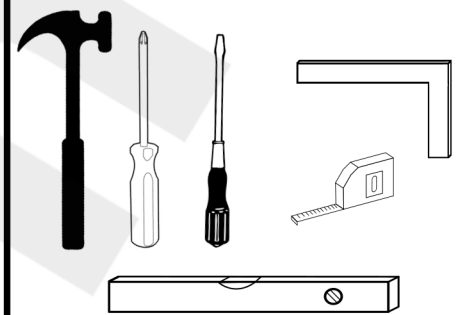
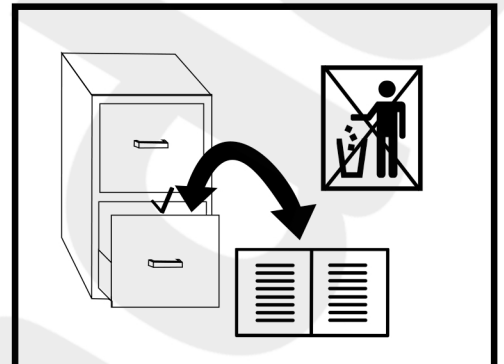
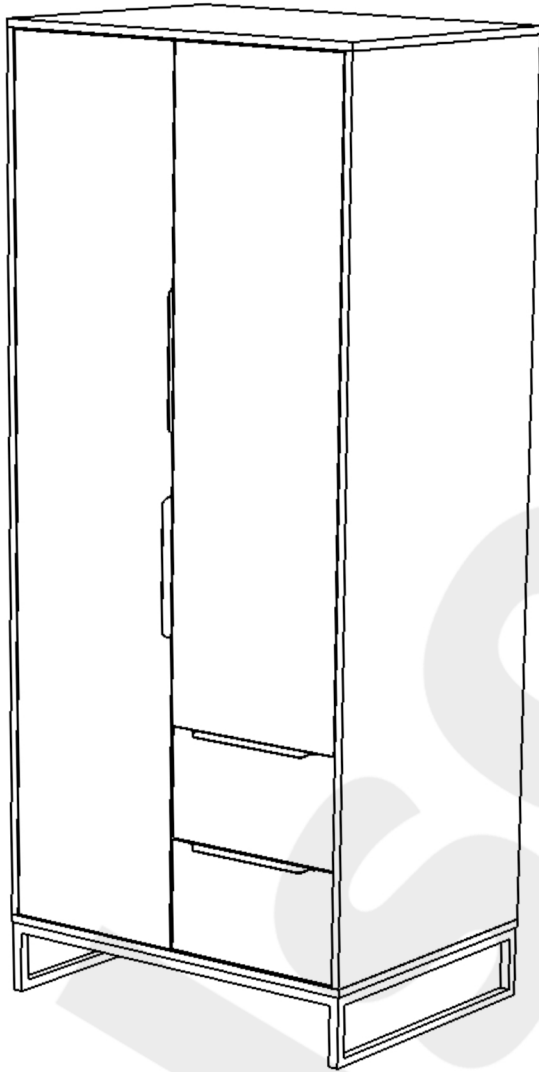

(PL) Przed montażem należy dokładnie zapoznać się z instrukcją montażu. Należy zamontować wszystkie akcesoria zabezpieczające oraz stosować się do wskazówek zawartych w instrukcji podczas montażu i użytkowania. Nie wolno stawiać na meblu ciężkich przedmiotów oraz używać go w innym celu niż jego przeznaczenie.

Po zmontowaniu należy wyrównać poziom i pion mebla oraz wyregulować drzwi na zawiasach.

Czyszczenie należy wykonywać wyłącznie za pomocą ściereczki lub lekko nawilżonego ręcznika. Nie stosować środków czyszczących do szorowania.

(DE) Lesen Sie vor der Installation die Montageanleitung sorgfältig durch. Installieren Sie alle Sicherheitszubehörteile und befolgen Sie während der Montage und Verwendung die Anweisungen im Handbuch. Stellen Sie keine schweren Gegenstände auf die Möbel und verwenden Sie sie nicht zweckentfremdet.

Richten Sie nach der Montage die Ebene und Vertikale des Möbels aus und justieren Sie die Flügeltür.

Die Reinigung sollte nur mit einem Lappen oder einem leicht angefeuchteten Tuch erfolgen. Verwenden Sie keine Scheuermittel.

(SK) Pred inštaláciou si pozorne prečítajte montážny návod. Nainštalujte všetko bezpečnostné príslušenstvo a počas montáže a používania dodržiavajte pokyny v návode. Na nábytok nekladte ťažké predmety a nepoužívajte ho na iný účel, než na ktorý je určený.

Po montáži zarovnajte úroveň a vertikálu nábytku a nastavte křídlové dvierka.

Čistenie by sa malo vykonávať iba handričkou alebo mierne navlhčenou utierkou. Nepoužívajte abrazívne čistiace prostriedky.

(RO) Vă rugăm să citiți cu atenție instrucțiunile de asamblare înainte de instalare. Instalați toate accesoriile de siguranță și urmați instrucțiunile din manual în timpul instalării și utilizării. Nu puneți obiecte grele pe mobilier și nu o utilizați contrar utilizării pentru care a fost prevăzut.

După asamblare, nivelați poziția mobilierului și reglați ușa cu balamale.

Curățarea trebuie făcută numai cu o cârpă sau un prosop ușor umed. Nu utilizați produse de curățare abrazive.

(FR) Avant l'installation, lisez attentivement les instructions de montage. Installez tous les accessoires de sécurité et suivez les instructions du manuel lors du montage et de l'utilisation. Ne placez pas d'objets lourds sur le meuble et ne l'utilisez pas à d'autres fins que celles pour lesquelles il a été conçu.

Après le montage, alignez le niveau et la verticale du meuble et ajustez la porte battante.

Le nettoyage doit être effectué uniquement avec un chiffon ou une serviette légèrement humide. N'utilisez pas de nettoyeurs à récurer.

(EN) Before installing, read the assembly instructions carefully. Install all safety accessories and follow the instructions during installation and use. Do not put heavy objects on the furniture and do not use it for any purpose other than its intended use.

After assembly, align the level and vertical of the furniture and adjust the hinged door.

Cleaning should only be done with a cloth or a slightly moistened towel. Do not use scouring cleansers.

(NL) Lees voor de montage de montagehandleiding aandachtig door. Installeer alle veiligheidsaccessoires en volg de instructies in de handleiding tijdens montage en gebruik. Plaats geen zware voorwerpen op het meubel en gebruik het niet voor een ander doel dan waarvoor het bedoeld is.

Lijn na montage het niveau en de verticaal van het meubel uit en stel de deur af.

Reiniging mag alleen worden gedaan met een doek of een licht bevochtigde handdoek. Gebruik geen schurende reinigingsmiddelen.

(CZ) Před instalací si pozorně přečtete montážní návod. Nainstalujte veškeré bezpečnostní příslušenství a během montáže a používání dodržujte pokyny v návodu. Na nábytek nepokládejte těžké předměty a nepoužívejte jej k jinému účelu, než ke kterému je určen.

Po montáži vyrovnejte úroveň polohu nábytku a nastavte pantové dveře.

Čištění by mělo být prováděno pouze hadříkem nebo mírně navlhčeným ručníkem. Nepoužívejte drhnoucí čisticí prostředky.

(HU) Telepítés előtt figyelmesen olvassa el az összeszerelési útmutatót. Szereljen be minden biztonsági tartozékot, és kövesse a kézikönyvben található utasításokat az összeszerelés és a használat során. Ne helyezzen nehéz tárgyakat a bútorra, és ne használja a rendeltetésétől eltérő célra.

Összeszerelés után állítsa be a bútorok szintjét és függőlegesét, és állítsa be a csuklós ajtót.

A tisztítást csak ruhával vagy enyhén megnedvesített törülközővel szabad elvégezni. Ne használjon súroló tisztítószereket.

(HR) Prije postavljanja pažljivo pročitajte upute za montažu. Ugradite sav sigurnosni pribor i slijedite upute u priručniku tijekom sastavljanja i uporabe. Ne stavljajte teške predmete na namještaj i nemojte ga koristiti u bilo koju drugu svrhu osim za koju je namijenjen.

Nakon montaže poravnajte razinu i okomitost namještaja i namjestite vrata na šarkama.

Čišćenje treba obavljati samo krpom ili blago navlaženim ručnikom. Nemojte koristiti sredstva za čišćenje.

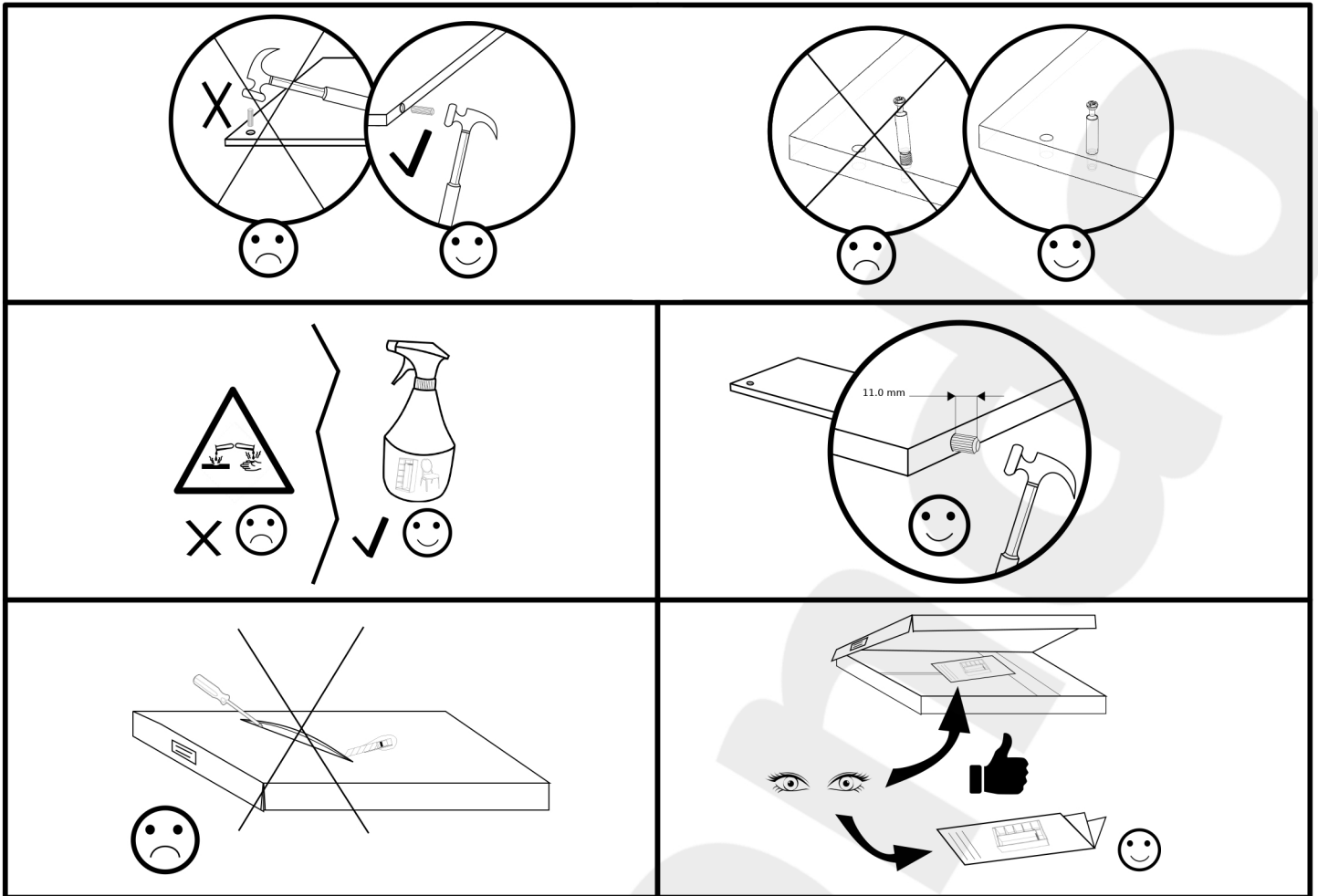

Akcesoria • Accessories • Zobehör

28	28	50	32	6	12	2	6	1	4	2
B	A	8.0x35	D 3.5x16 W2	G	I	KS	PZ	U1	G4	L-368
X	L-500	PK 3.0x20 W1	3.5x16 W4	S3 3.0x16 W3	256	UL	Z	O	G2	N2
20	2	8	2	8	8	4	6	2	6	4

1	4	4
U2	US	4.0x35 W11

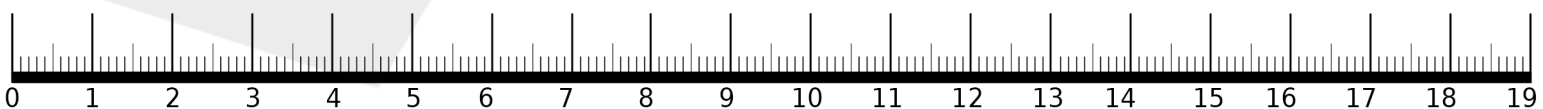

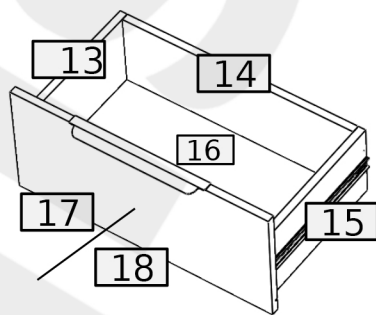
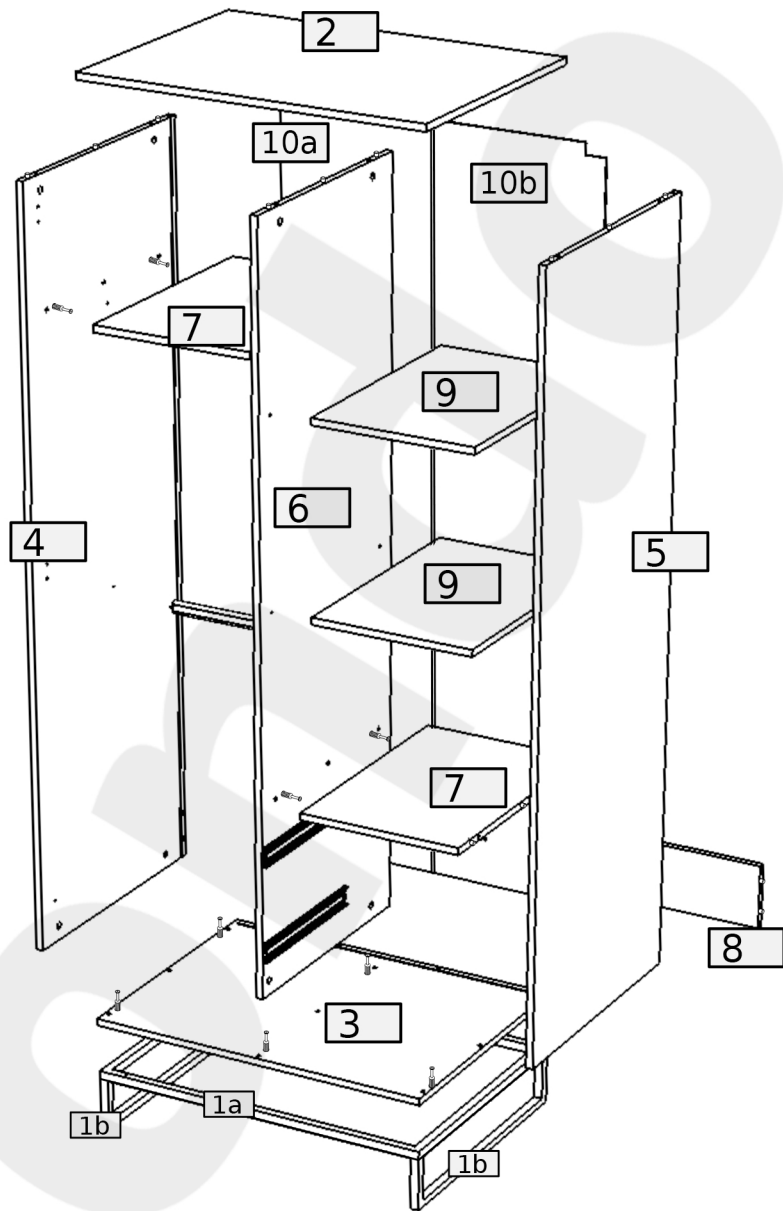
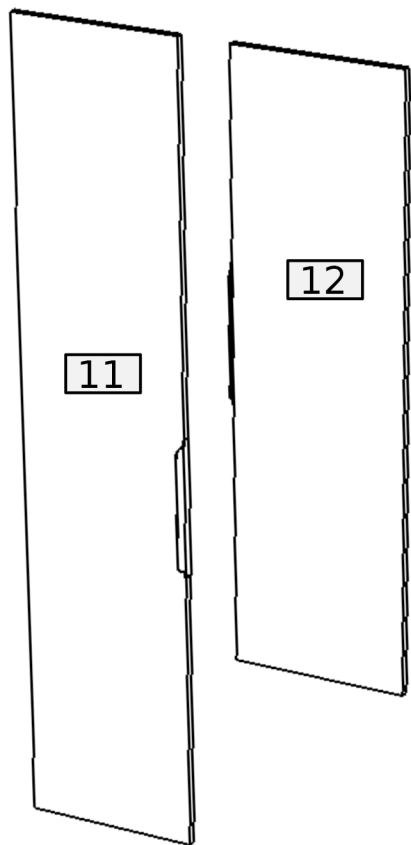

No.	Pcs.	L	W	D	Pac
1a	1	795	595	20	2/3
1b	1	120	595	20	2/3
2	1	800	600	16	2/3
3	1	800	600	16	2/3
4	1	1728	599	16	1/3
5	1	1728	599	16	1/3
6	1	1728	560	16	1/3
7	2	560	375	16	2/3
8	1	766	150	16	2/3
9	2	550	375	16	3/3
10a	1	1742	390	3	1/3
10b	1	1742	390	3	1/3
11	1	1722	380	16	3/3
12	1	1280	380	16	3/3
13	2	550	160	16	2/3
14	2	318	142	16	2/3
15	2	550	160	16	2/3
16	2	557	333	3	1/3
17	1	380	217	16	3/3
18	1	380	217	16	3/3

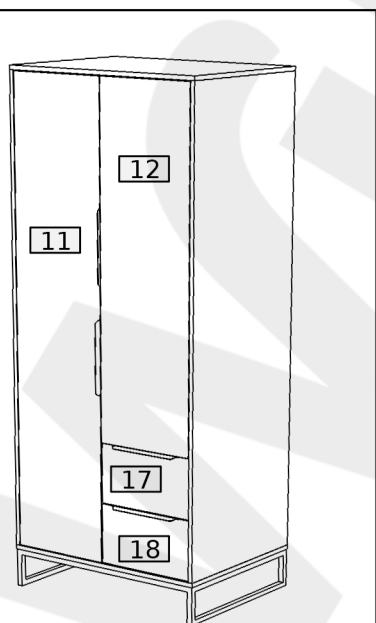

①

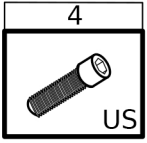
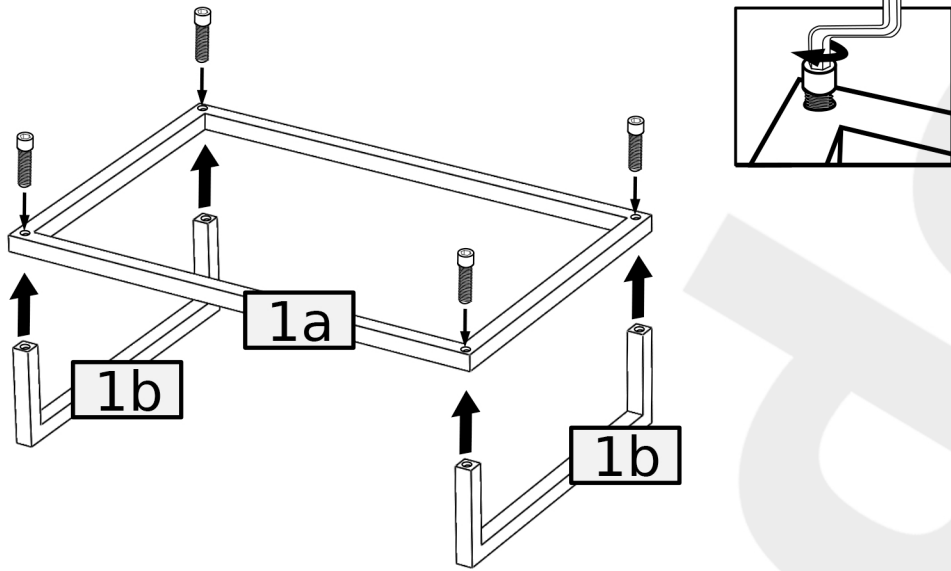

②

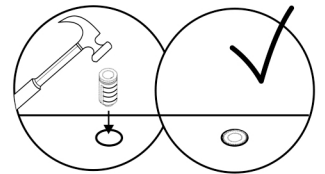
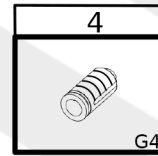
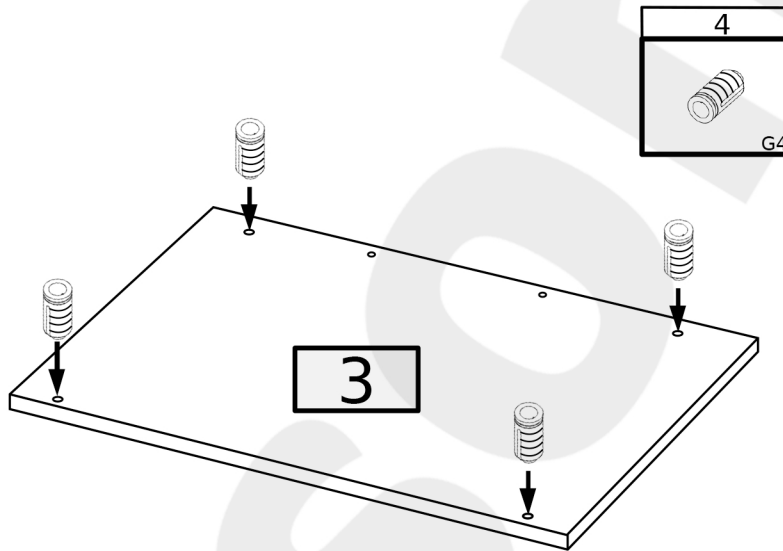

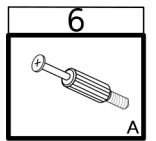
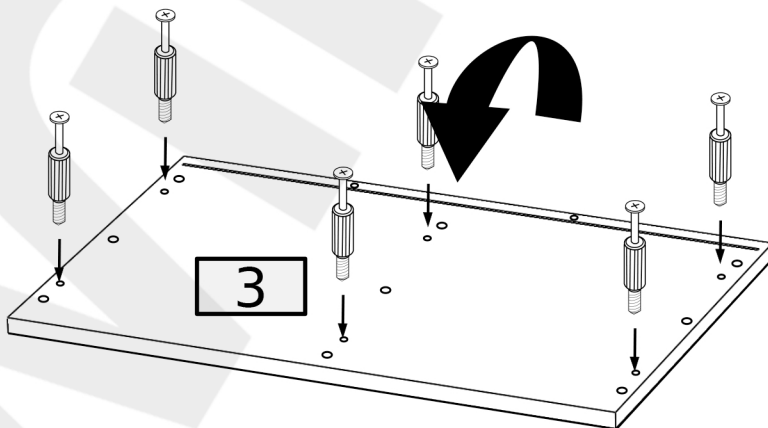

③

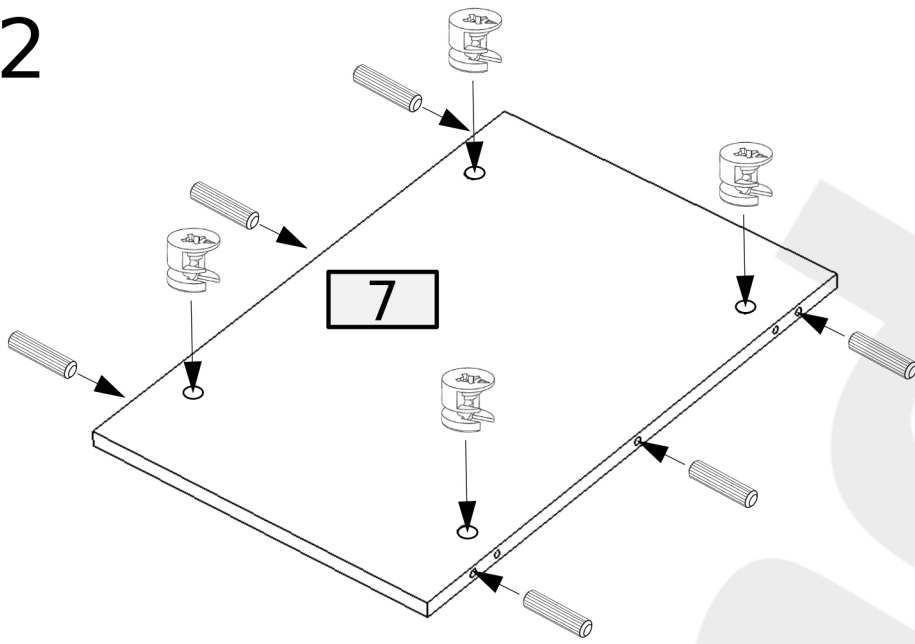

④ x2



6	4
	
8.0x35	B

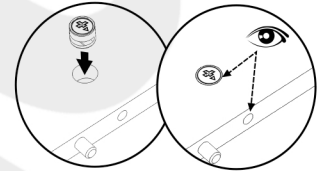

⑤

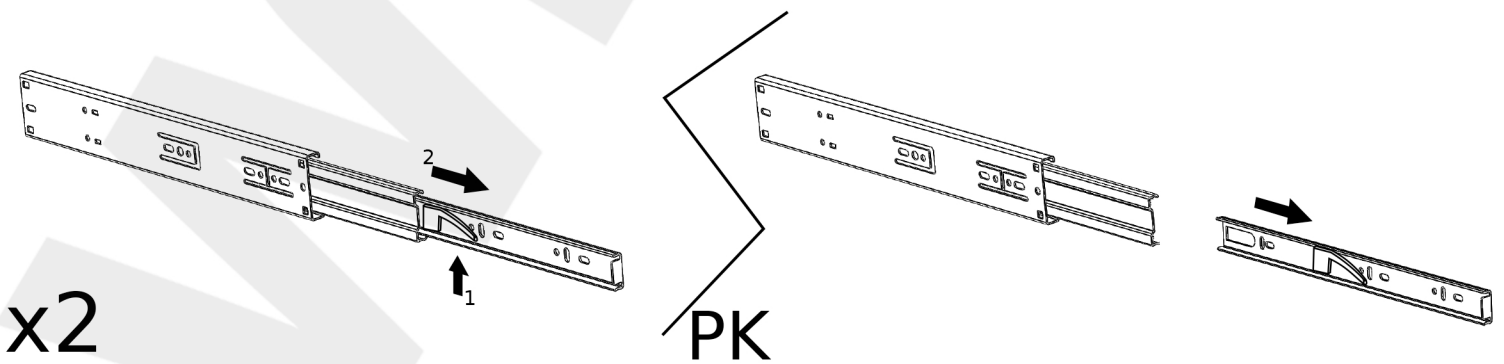
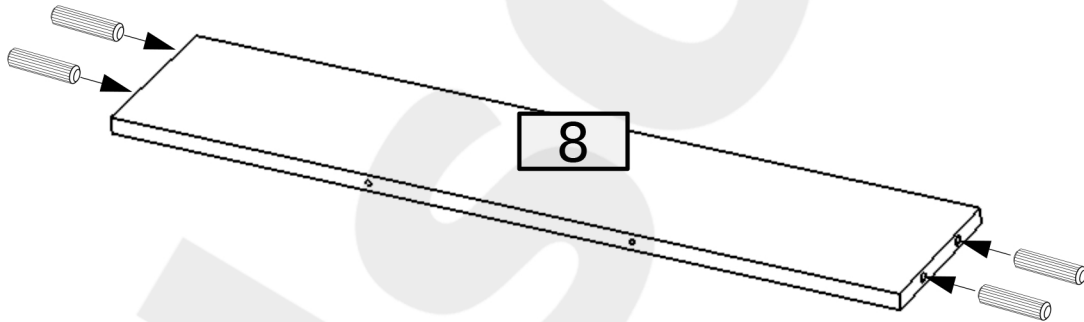
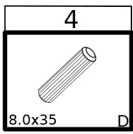

x2

PK

6

6	4	2	3
8.0x35	D	A	PZ

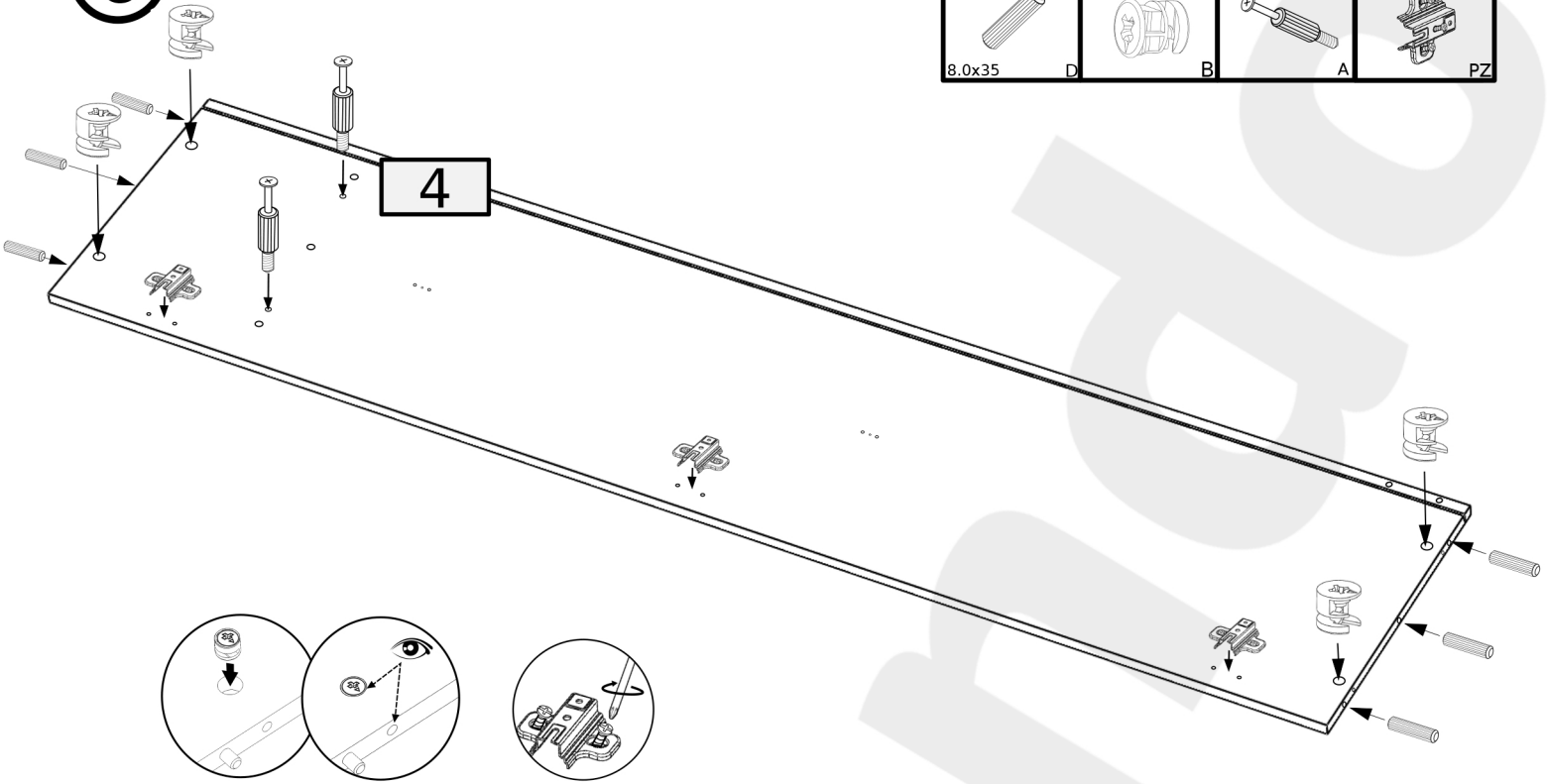

7

6	4	6	4	2	4	3
8.0x35	D	A	3.5x16 W2	PK	S3	PZ

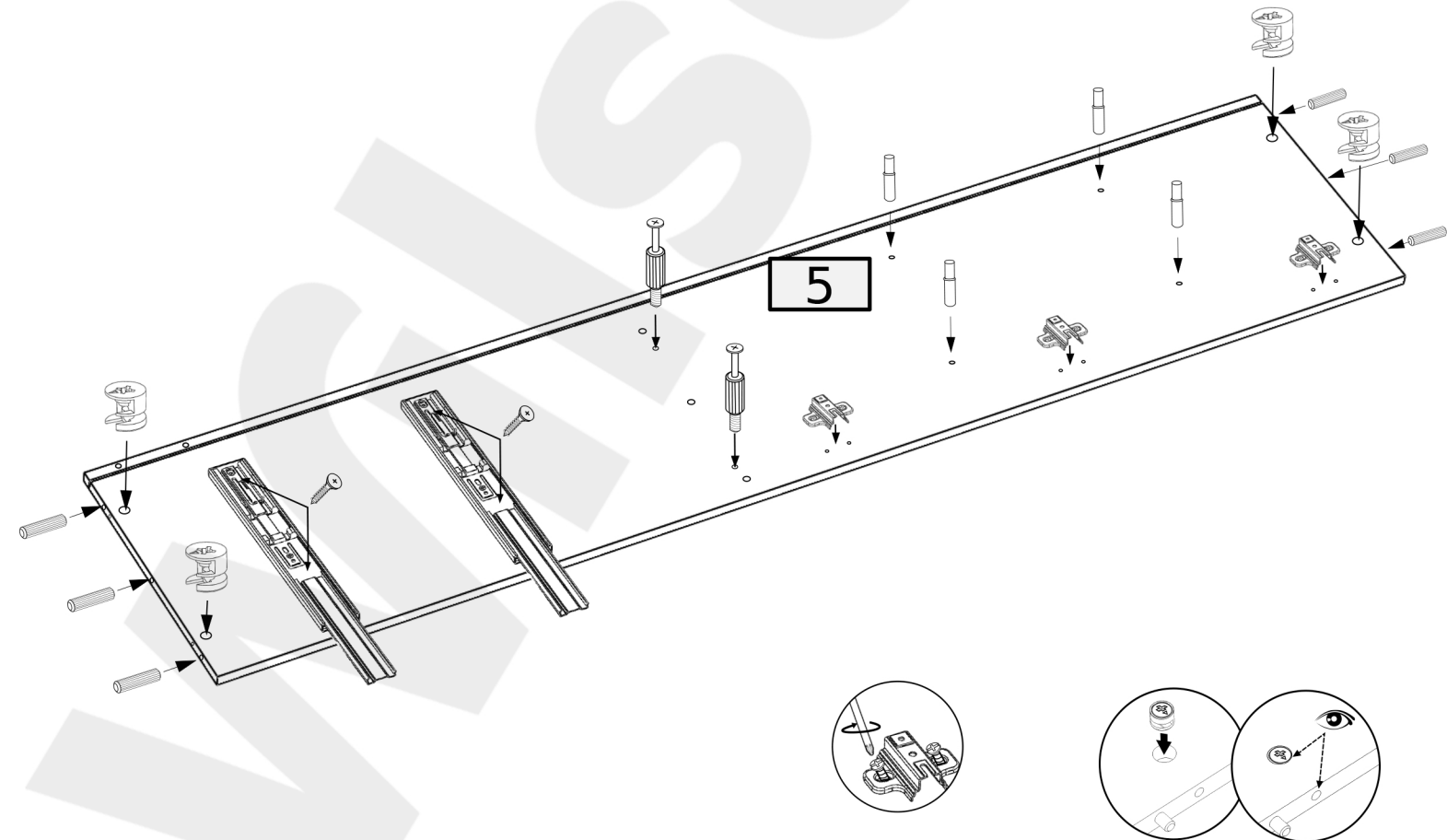



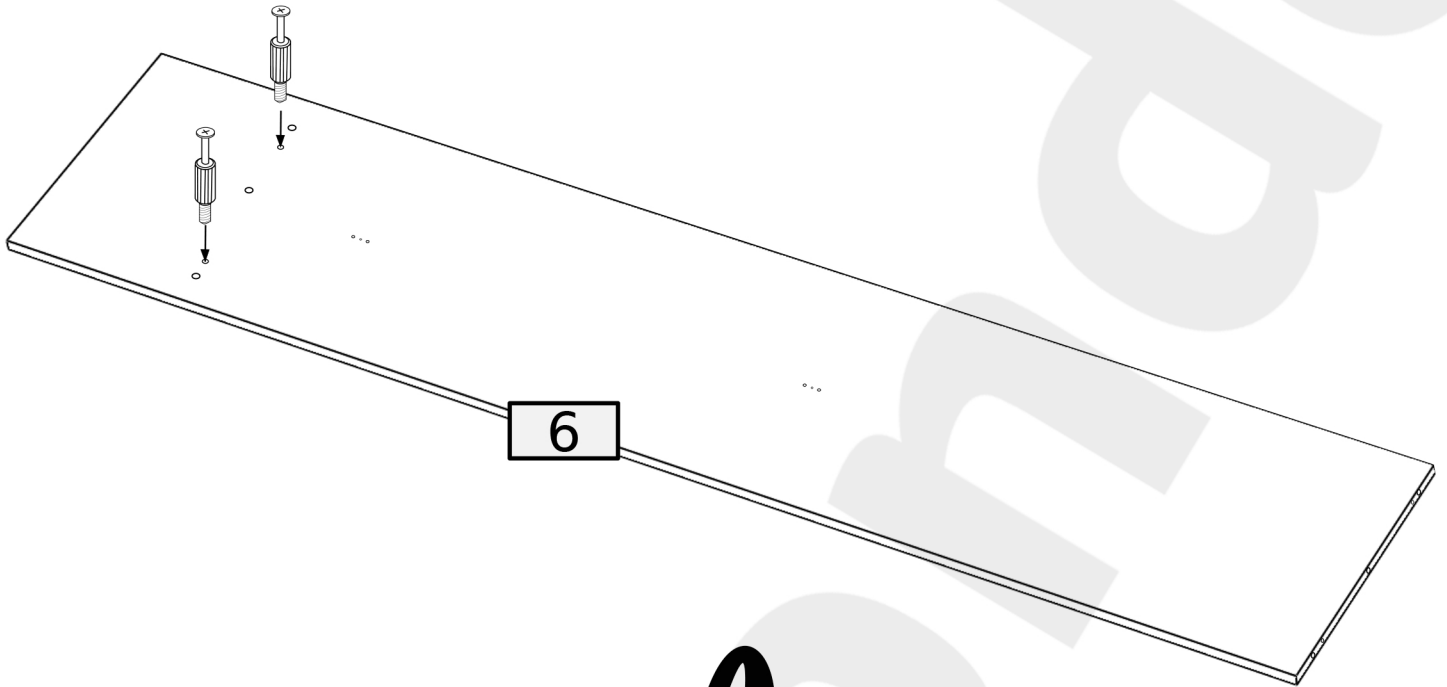
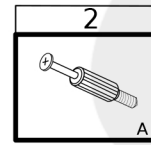

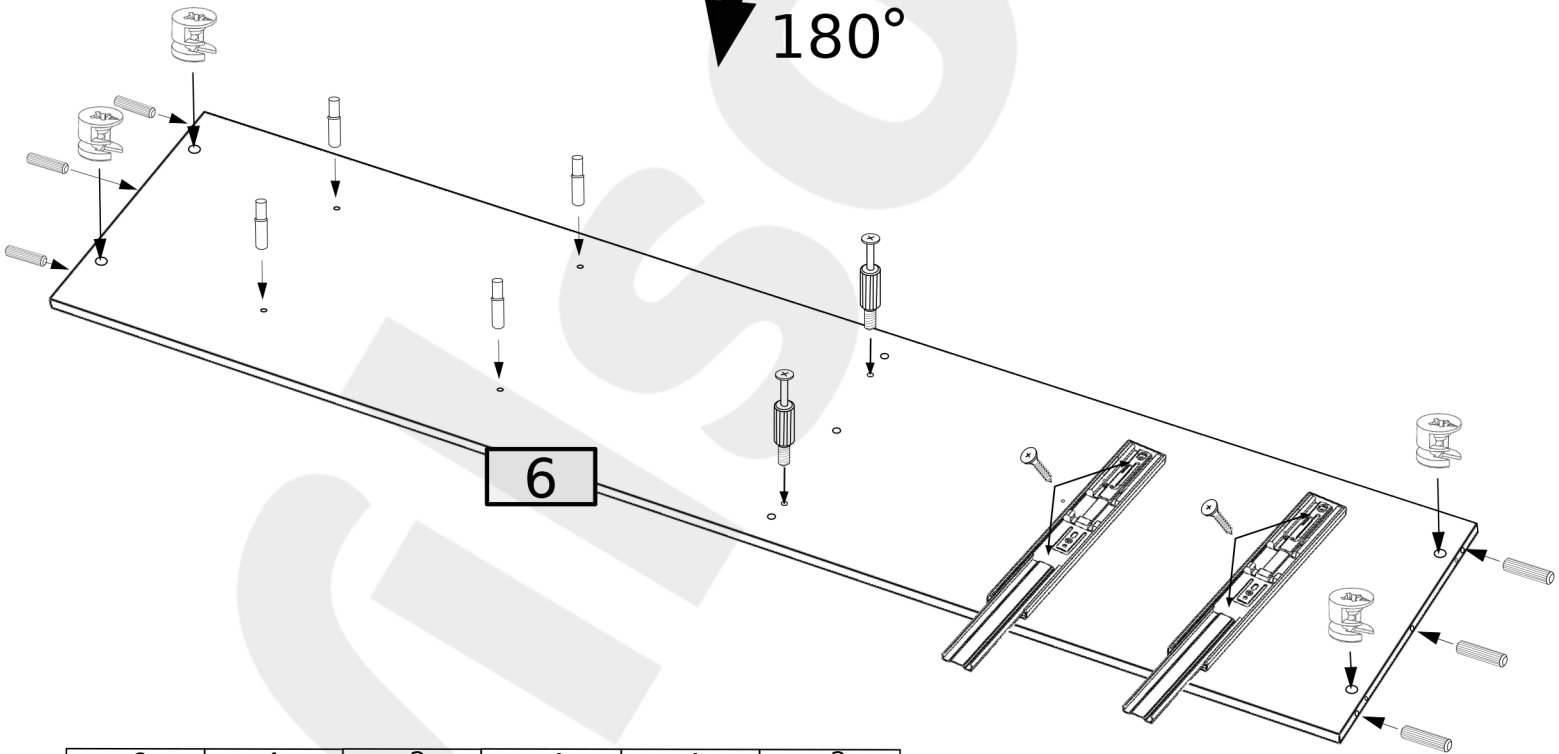

8

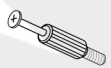

180°

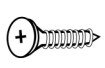

6	4	2	4	4	2
					
8.0x35	D	A	S3	3.5x16 W2	PK

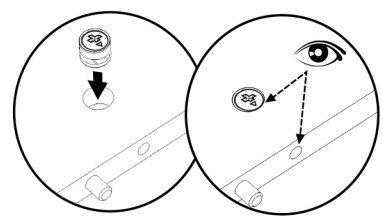

9

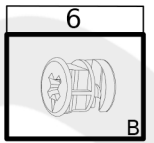
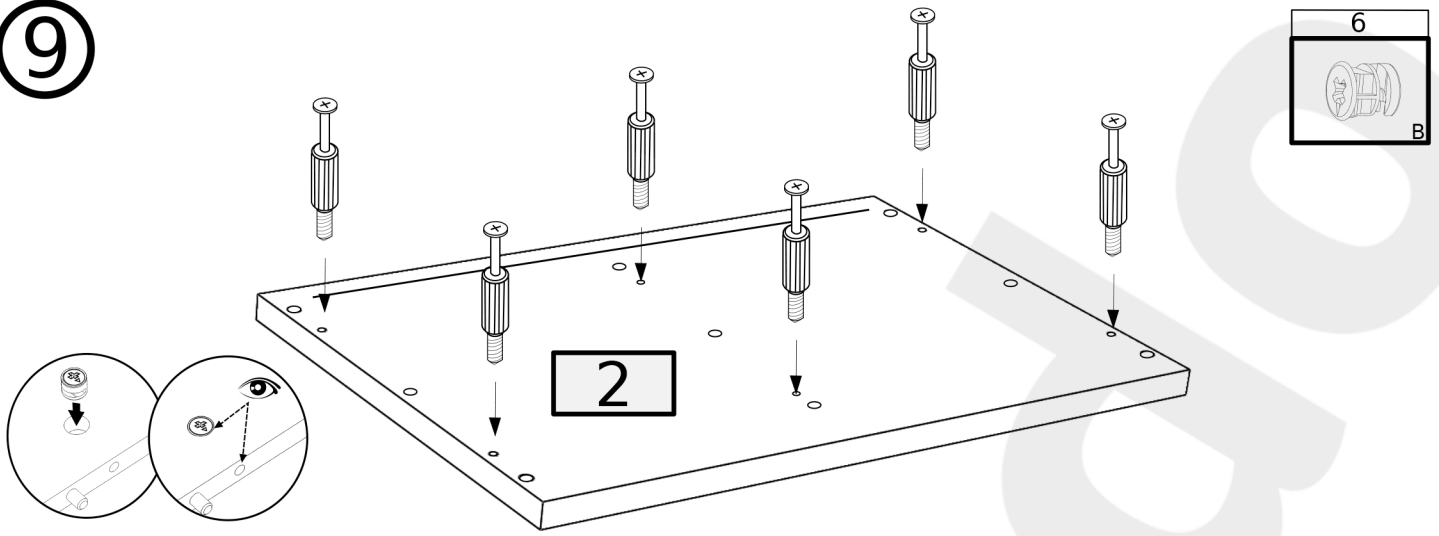

10 x2

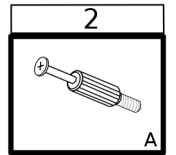
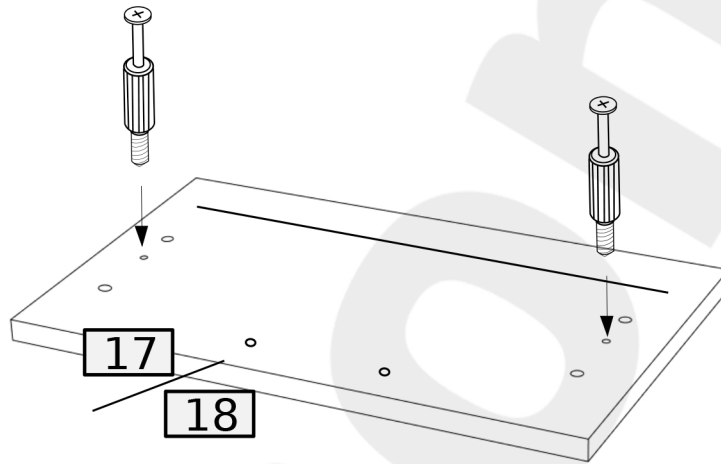

11 x2

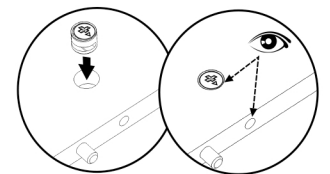
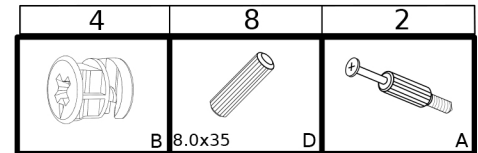
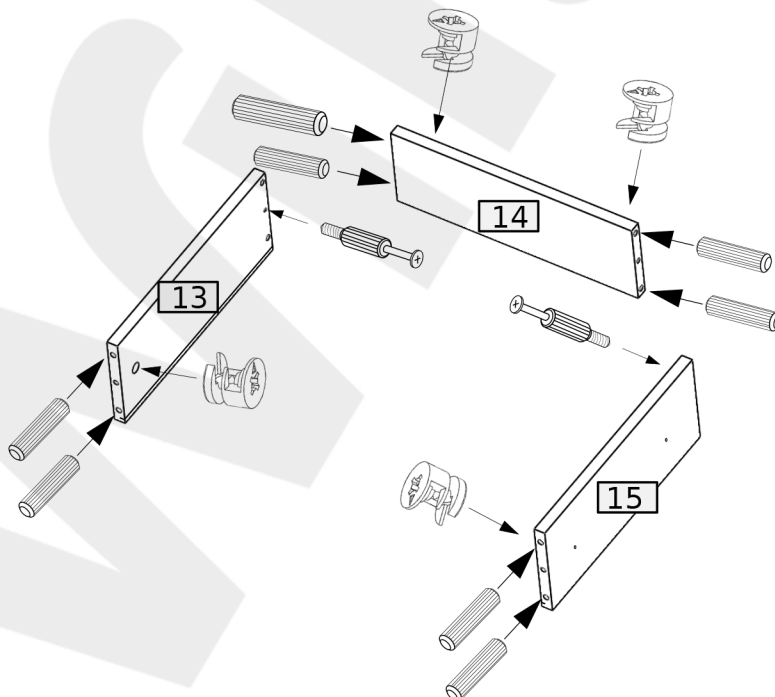

⑫ x2

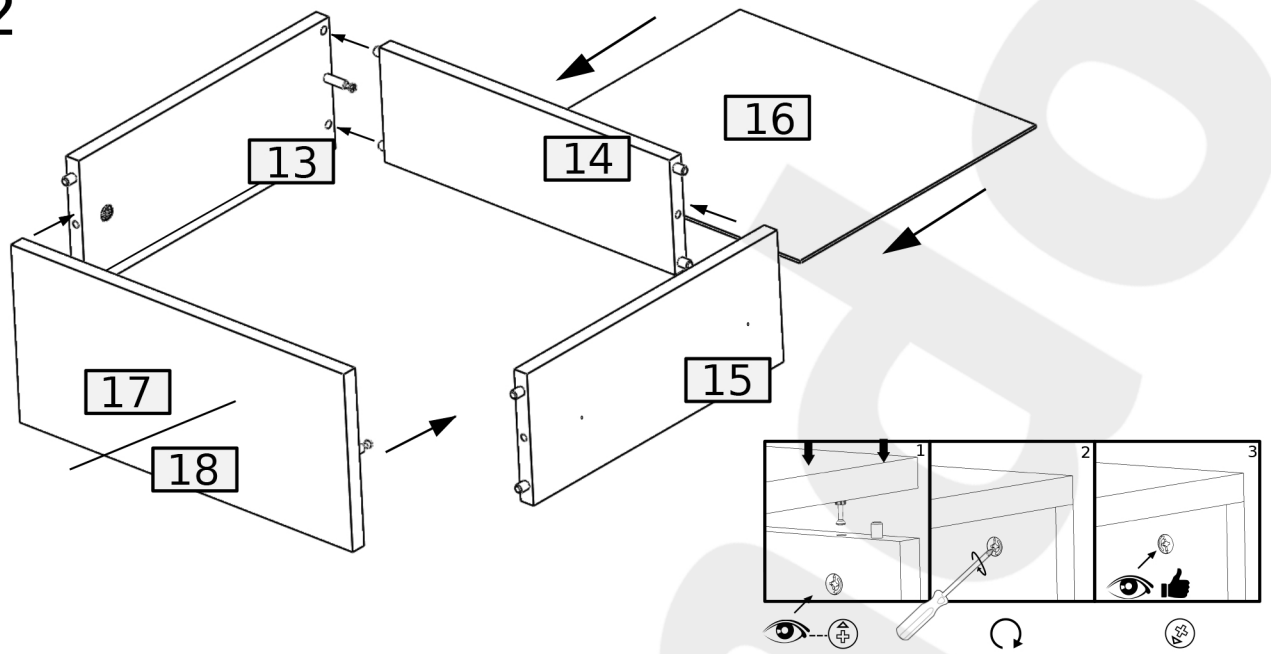

⑬ x2

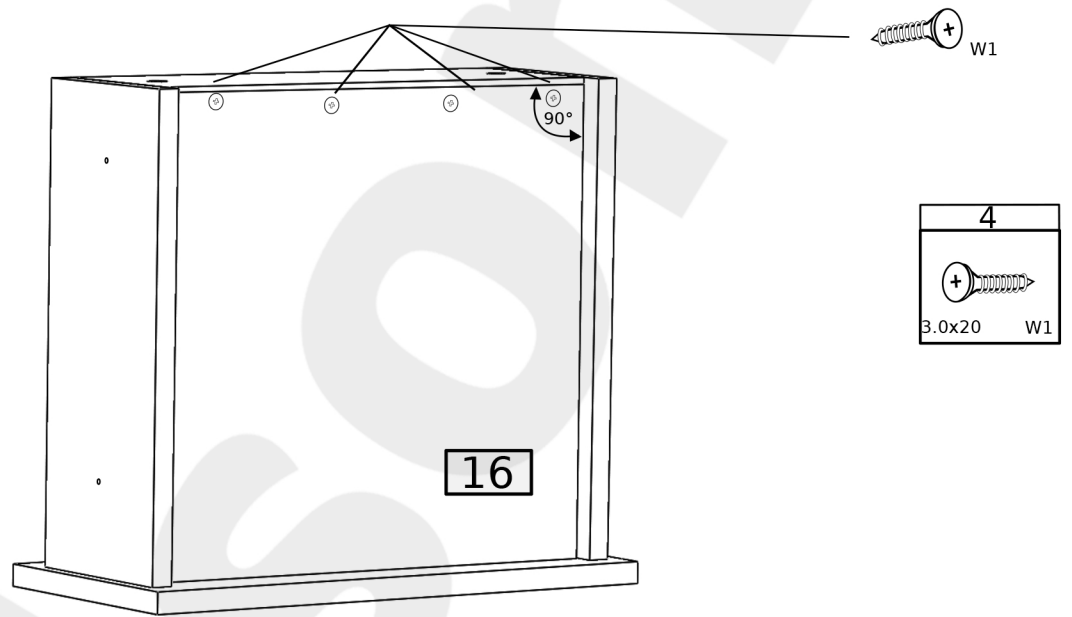

⑭ x2

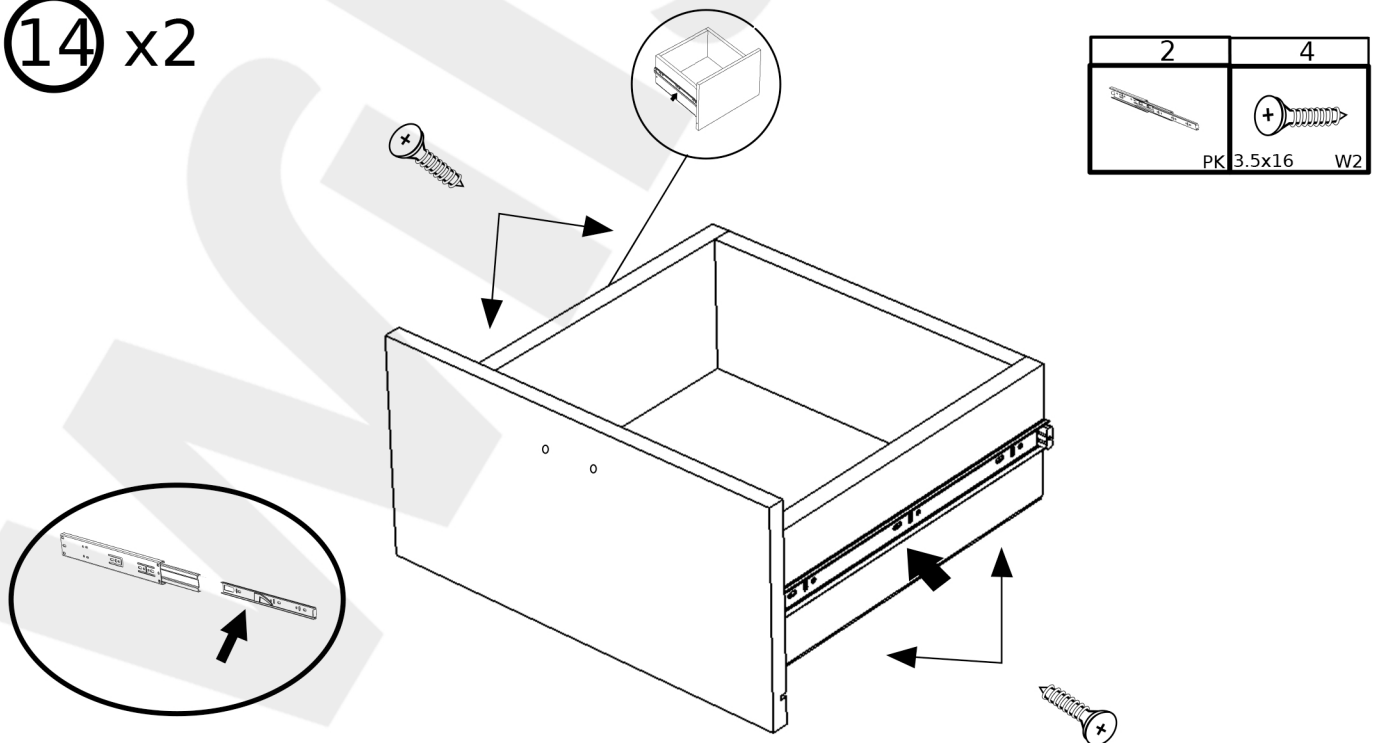

15

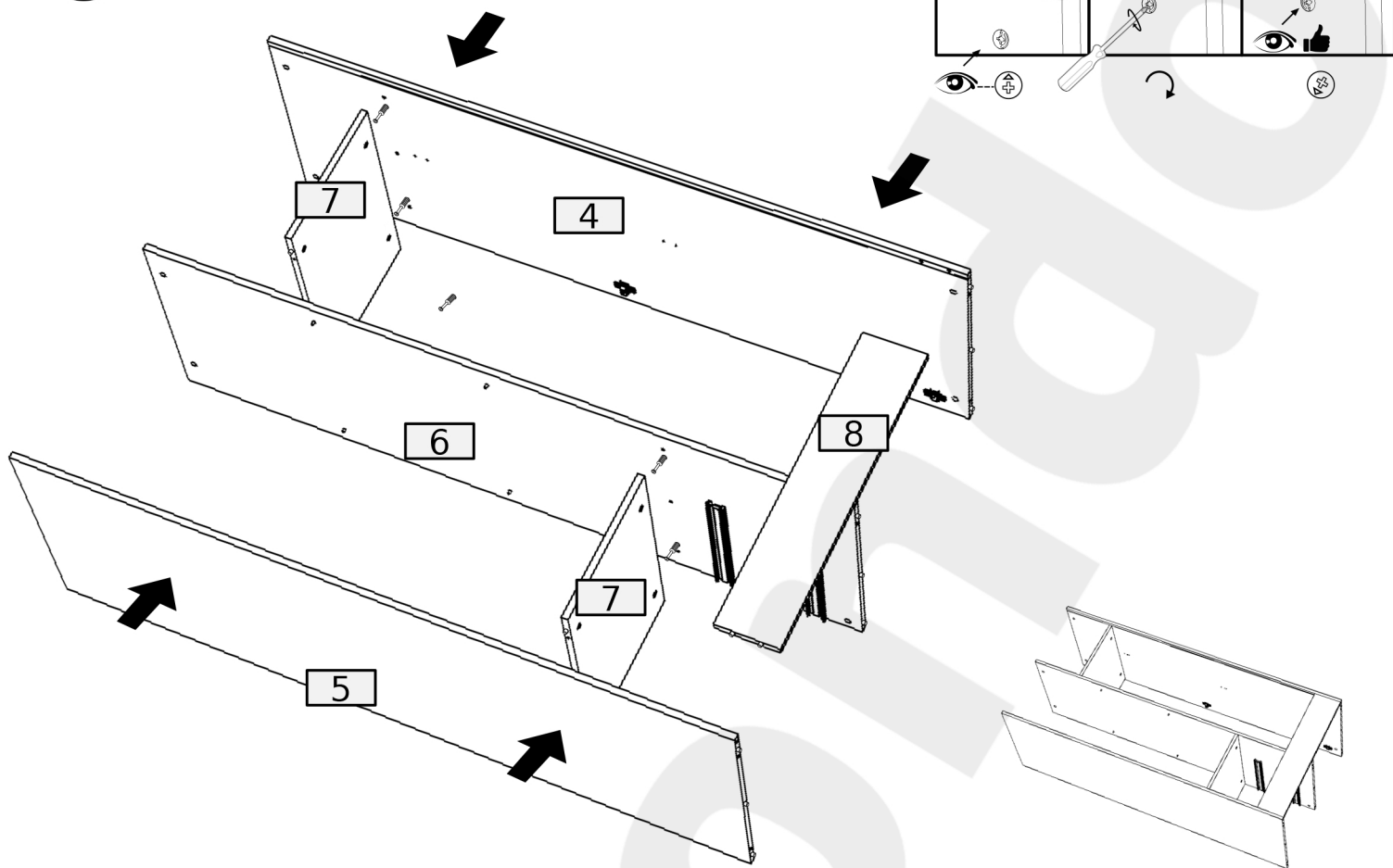

16

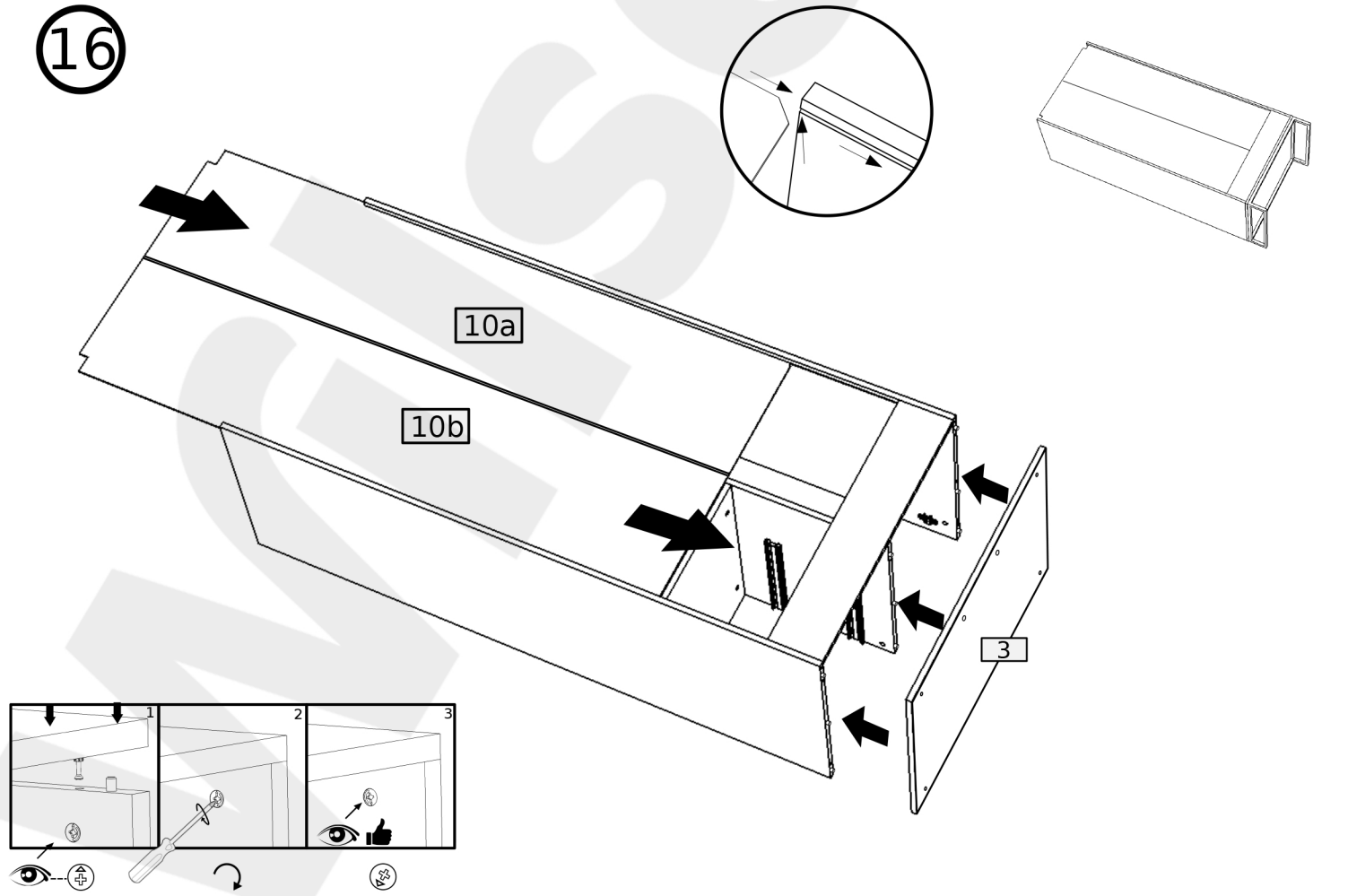

17

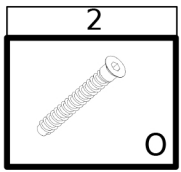
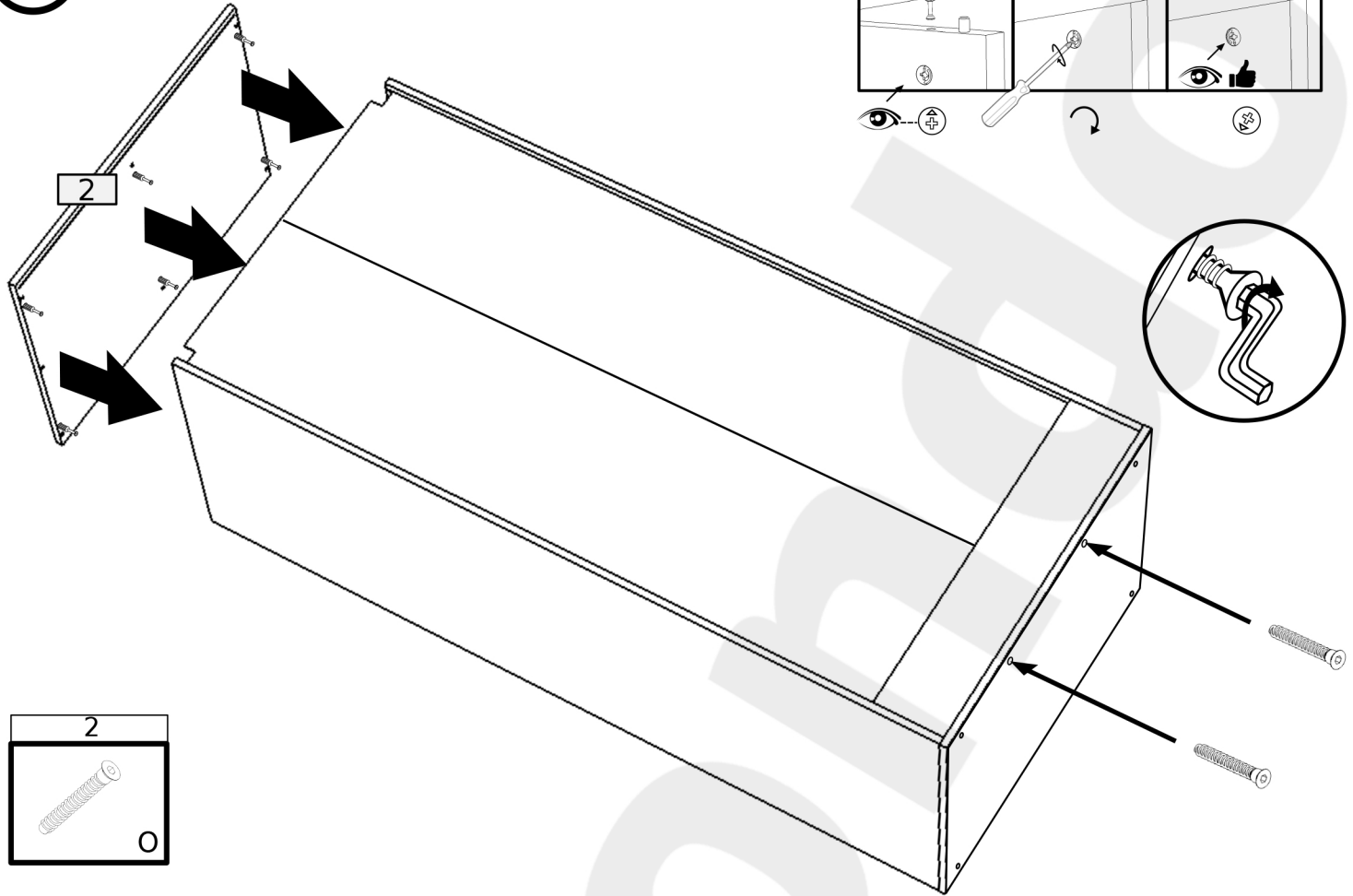
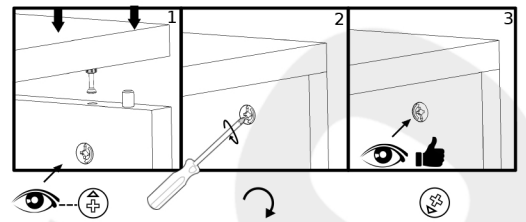

18

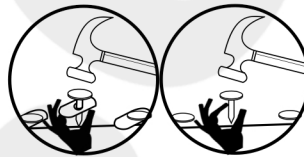

12	6	4
	G	4.0x35 W11

6
G2

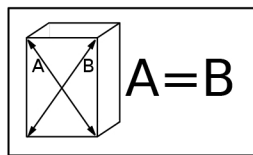
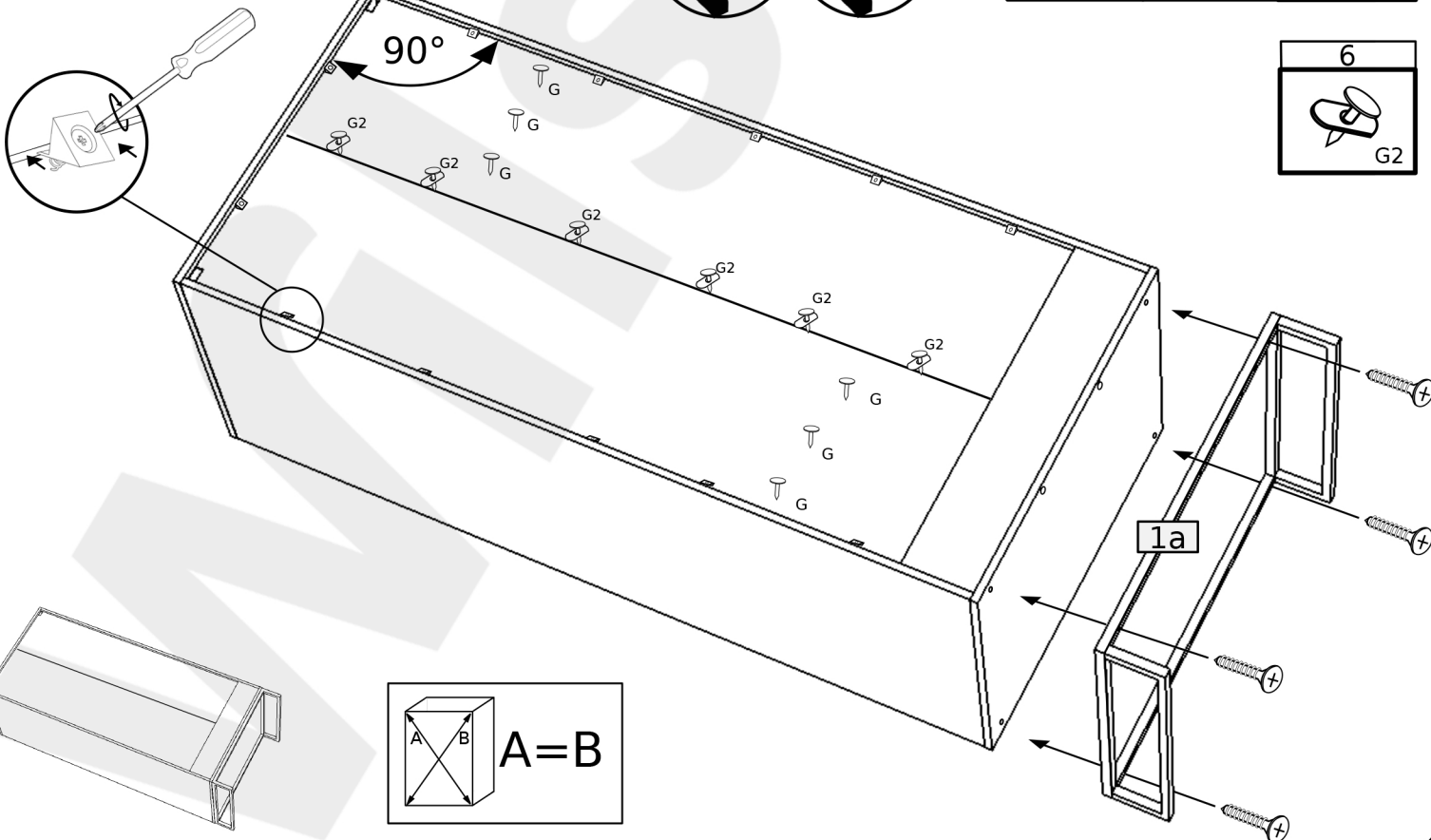

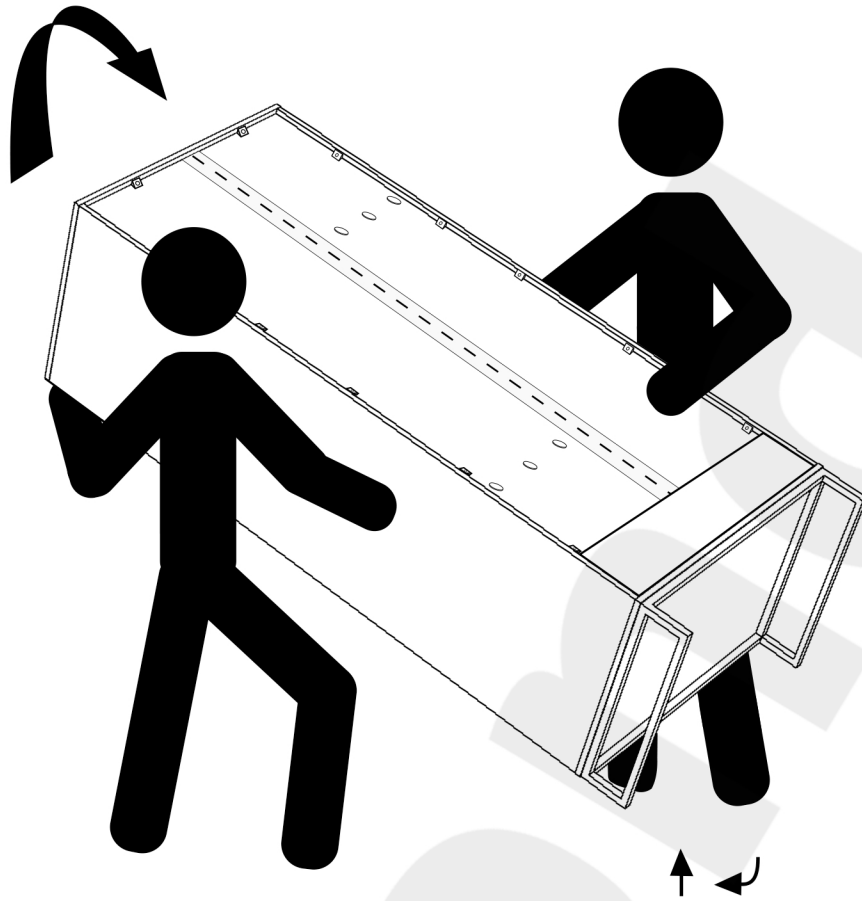

19



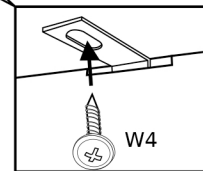
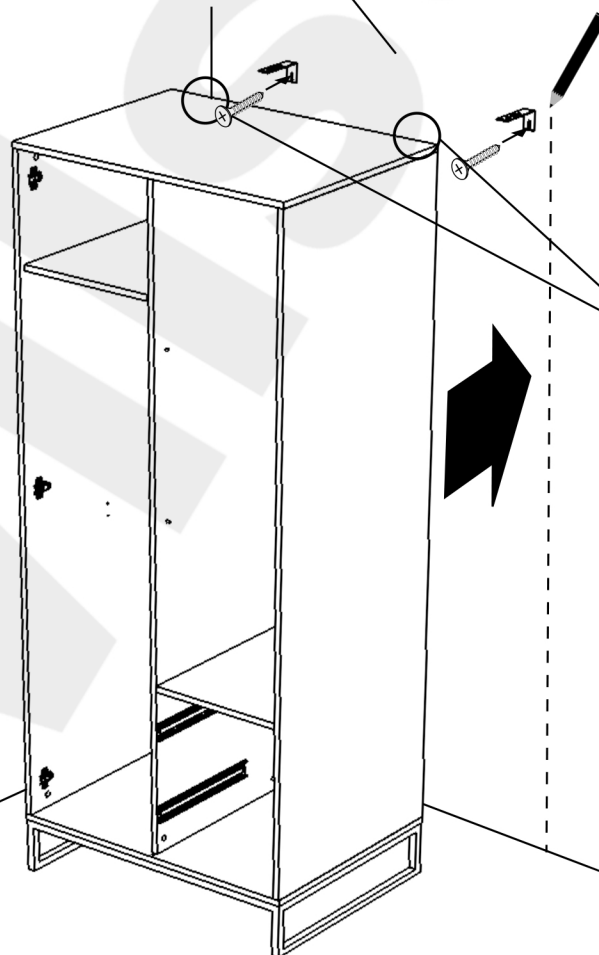
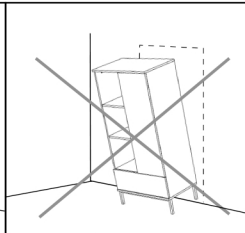
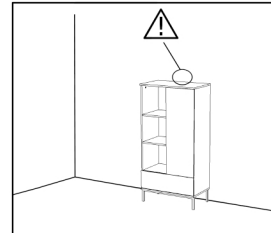
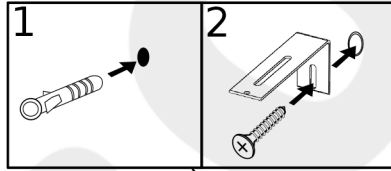

20



2	2
 3.5x16	 W4 KS

21

 3.5x16 W2	 N2
4	4

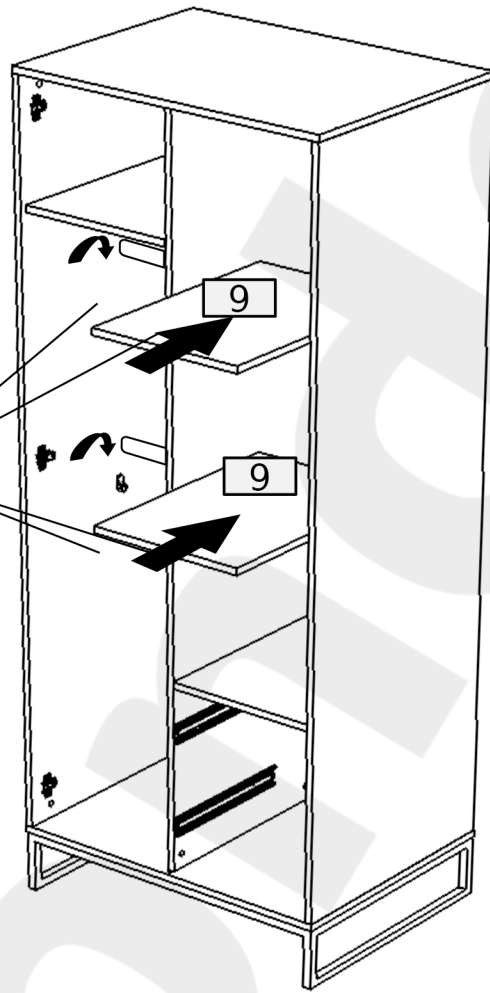
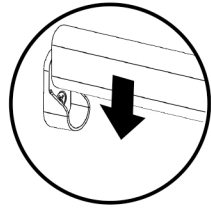
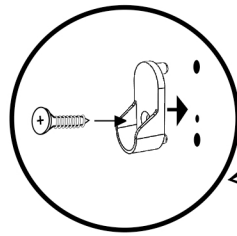

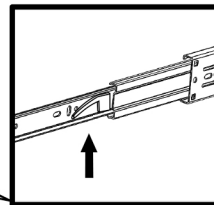
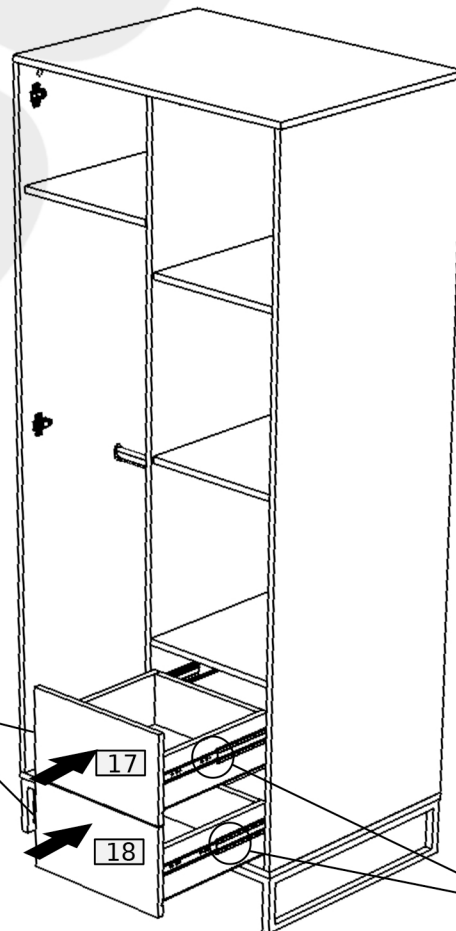
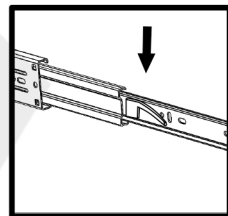

22

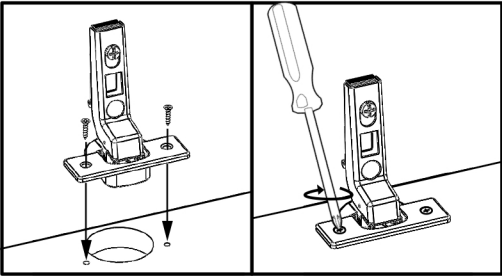
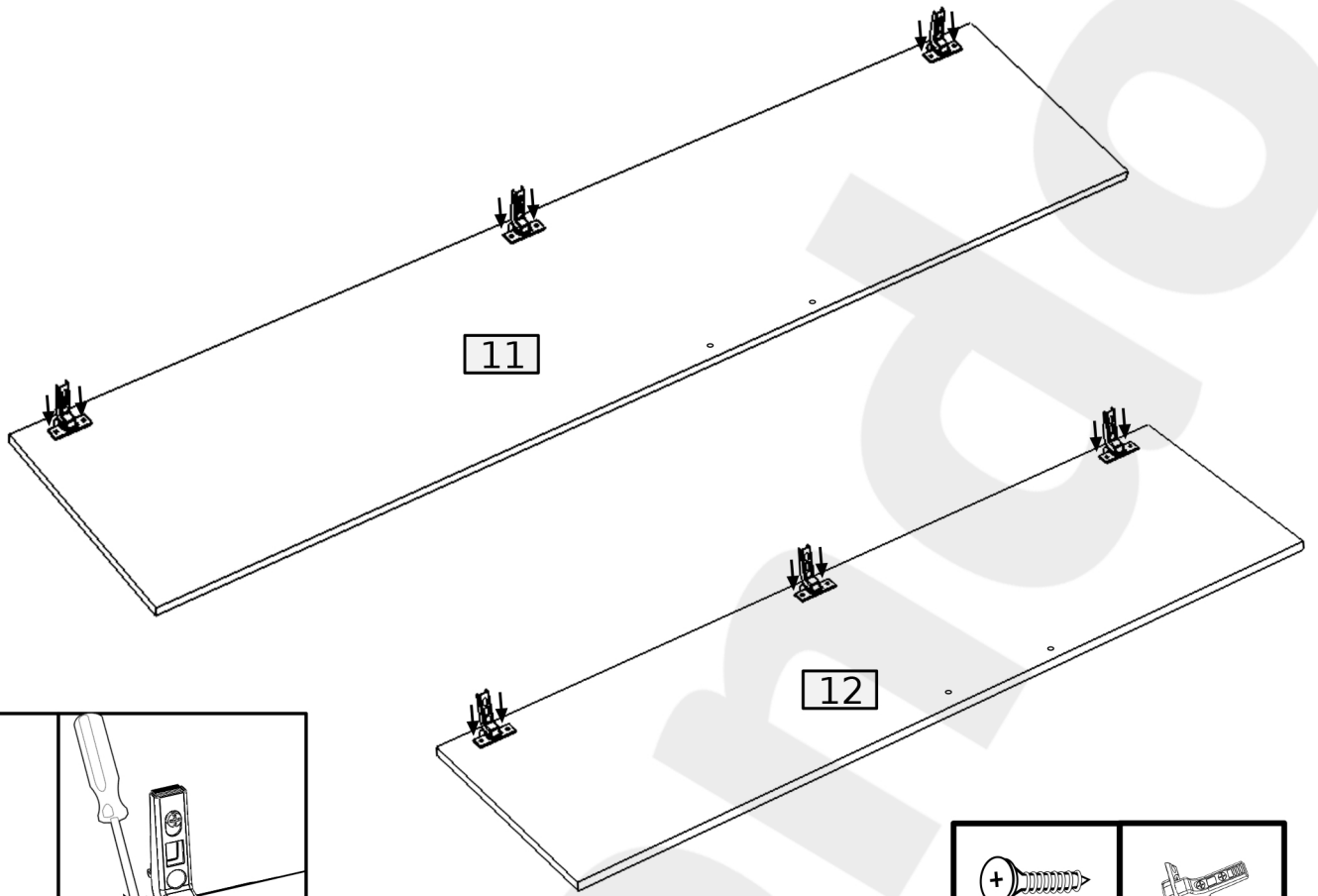

23



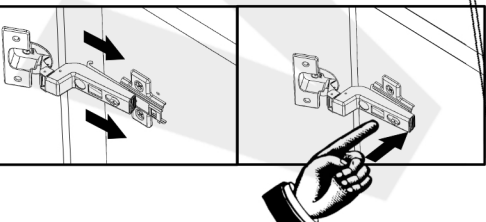
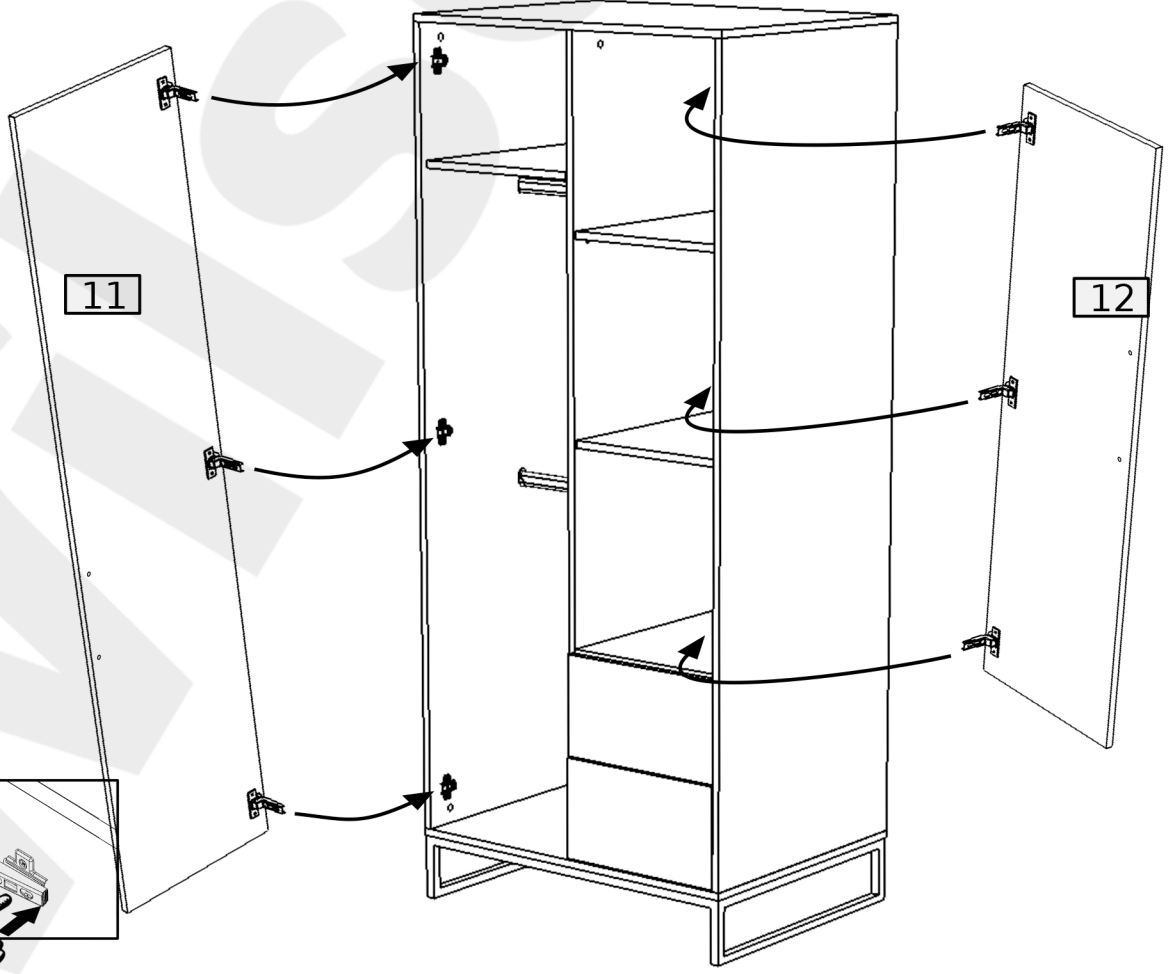

 3.5x16 W2	 Z
12	6

24

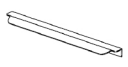

25

2	4
	
UL	3.0x16 W3

