







<b>8x30</b> K 6x	<b>15/12</b> M 3x	<b>L20,3</b> T 3x	<b>7x50</b> KF 2x	<b>6,3x9</b> E2 2x	<b>SW4</b> KL 1x	<b>ZW</b> 1x	<b>R</b> 1x

1

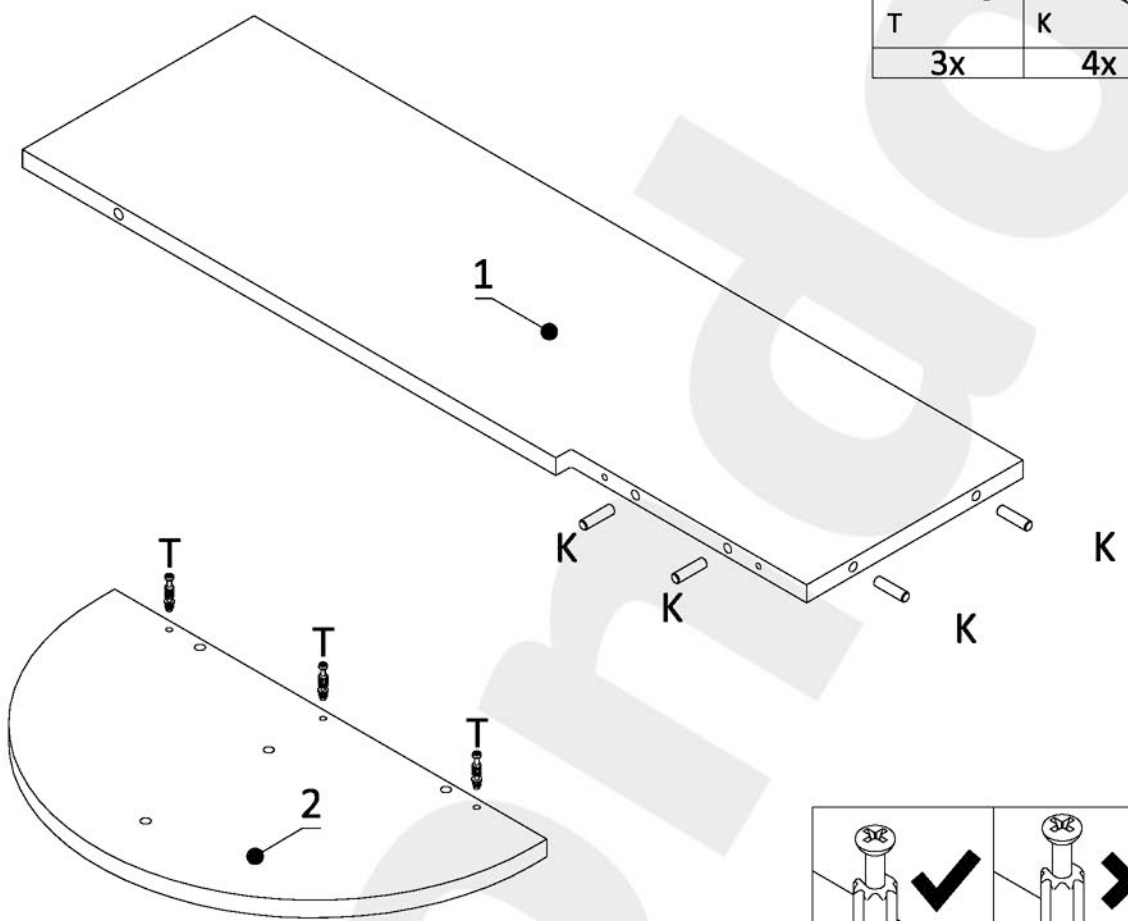
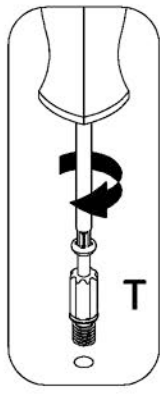
	
T	K
3x	4x



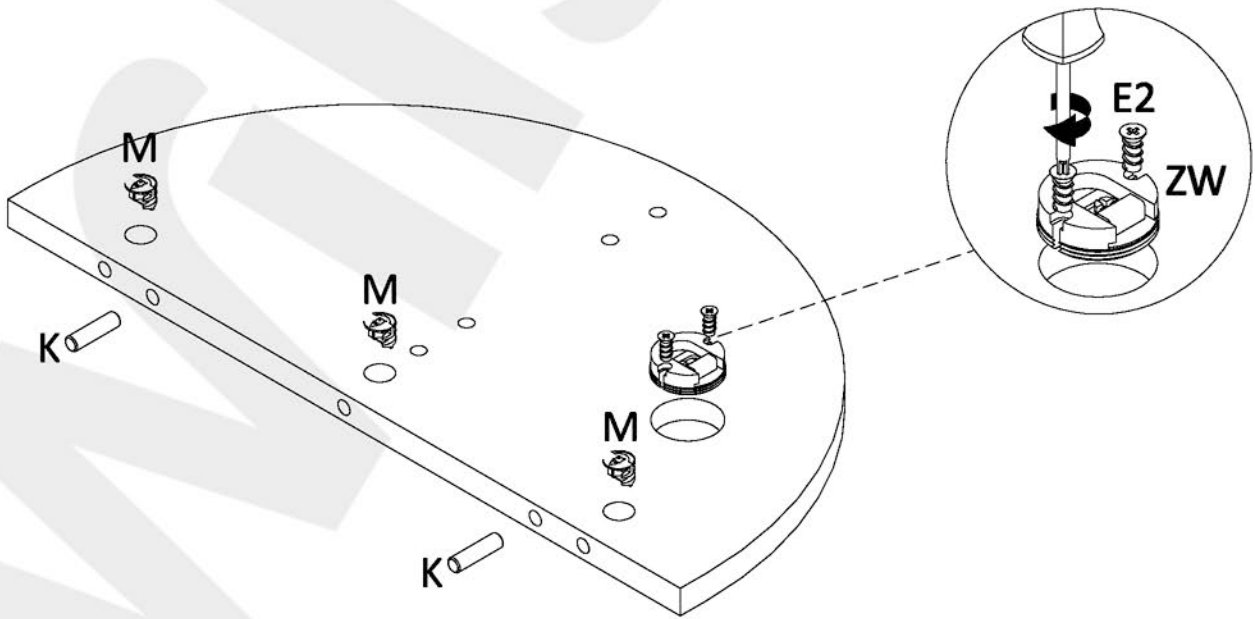

2

			
K	M	E2	ZW
2x	3x	2x	1x



3

	
KF	KL
2x	1x

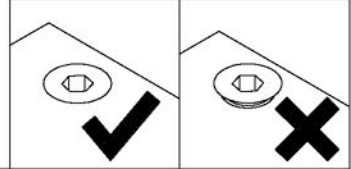
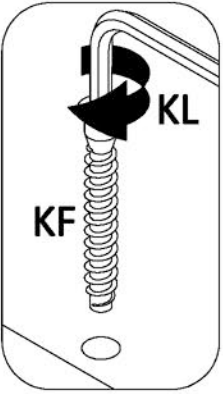
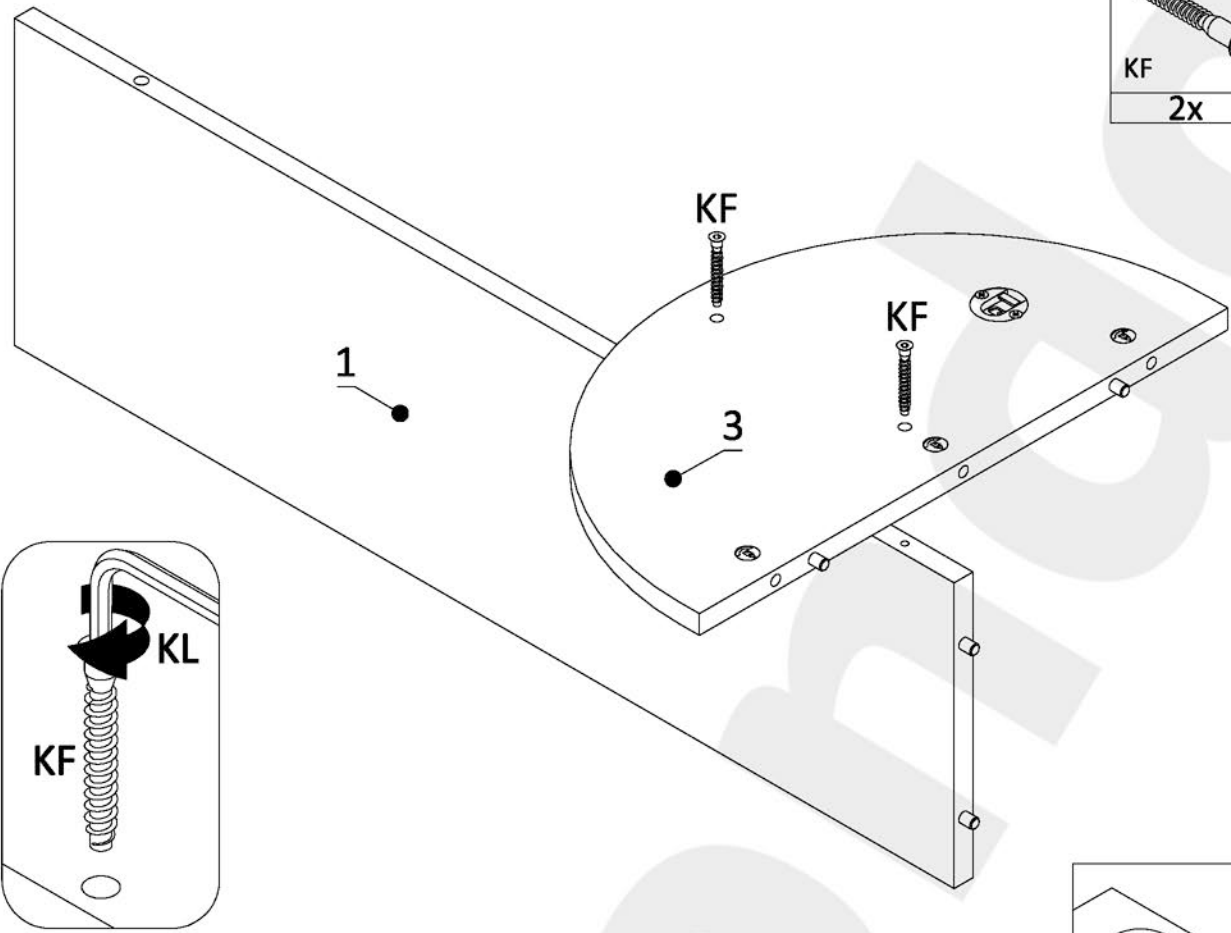

4

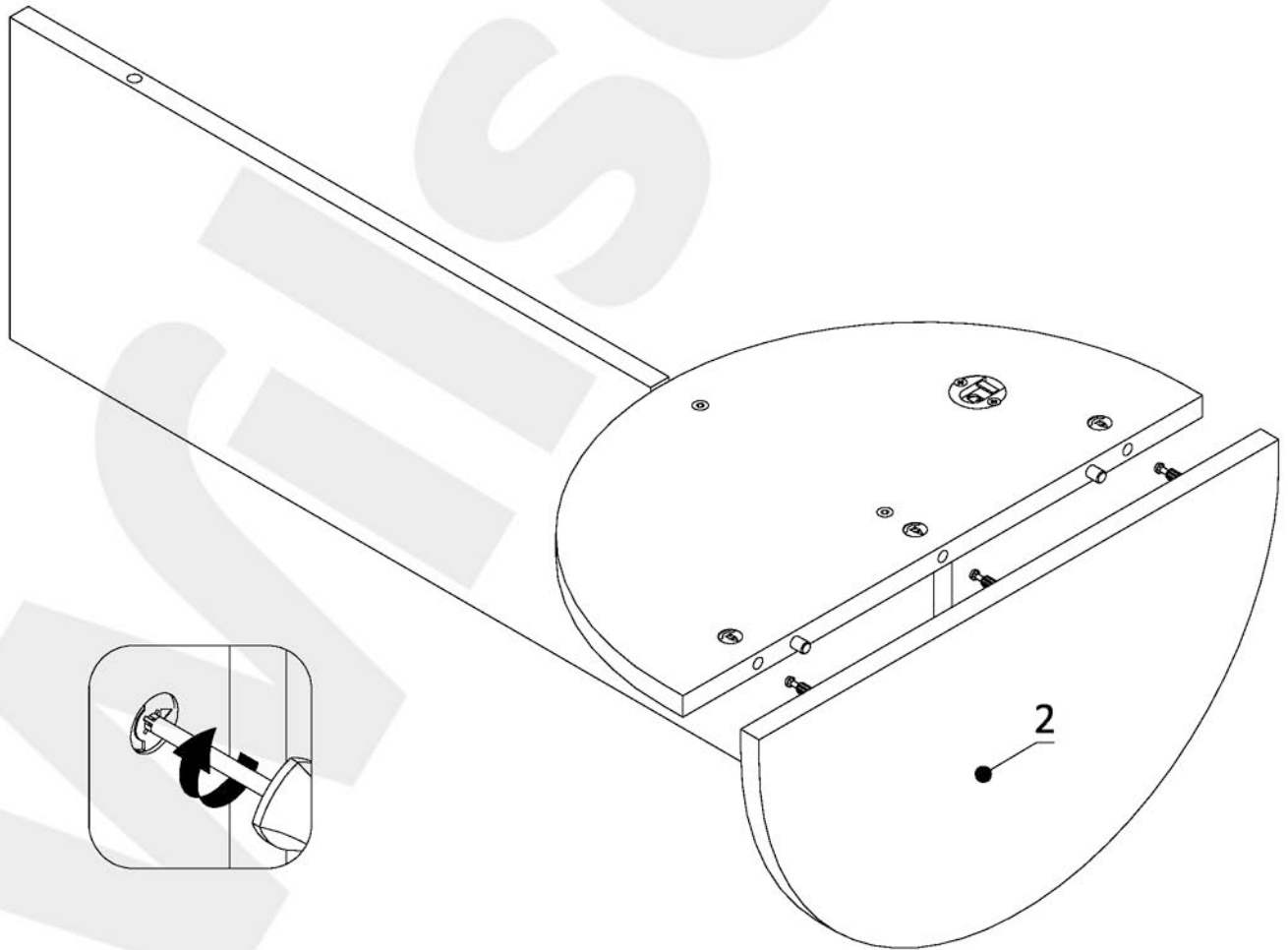

5

