

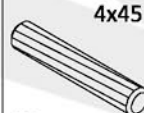





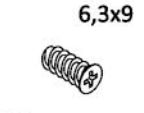

 8x30 K 2x	 4x45 K2 2x	 7x50 KF 4x	 6,3x9 E2 2x	 SW4 KL 1x	 ZW 1x	 R 1x
---	---	---	--	--	---	---

1

	
ZW	E2
1x	2x

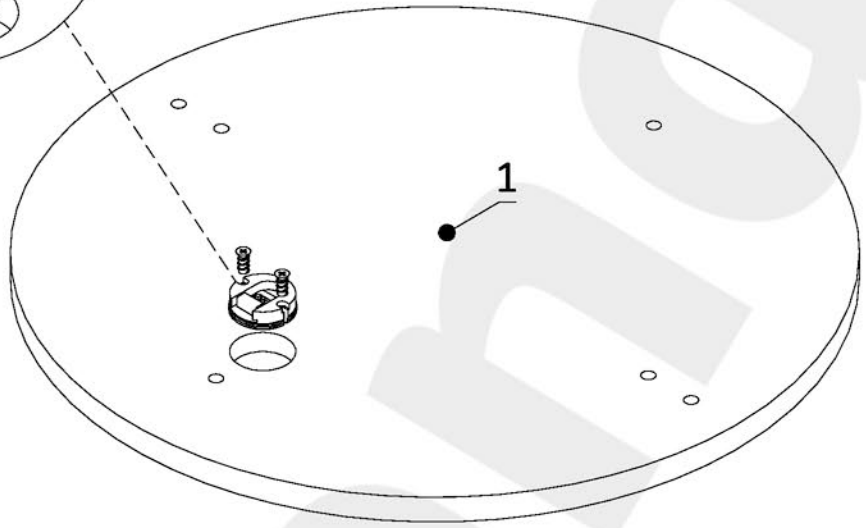
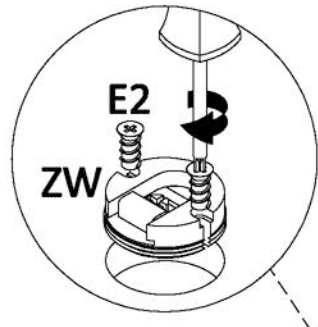

2

	
K2	K
2x	2x

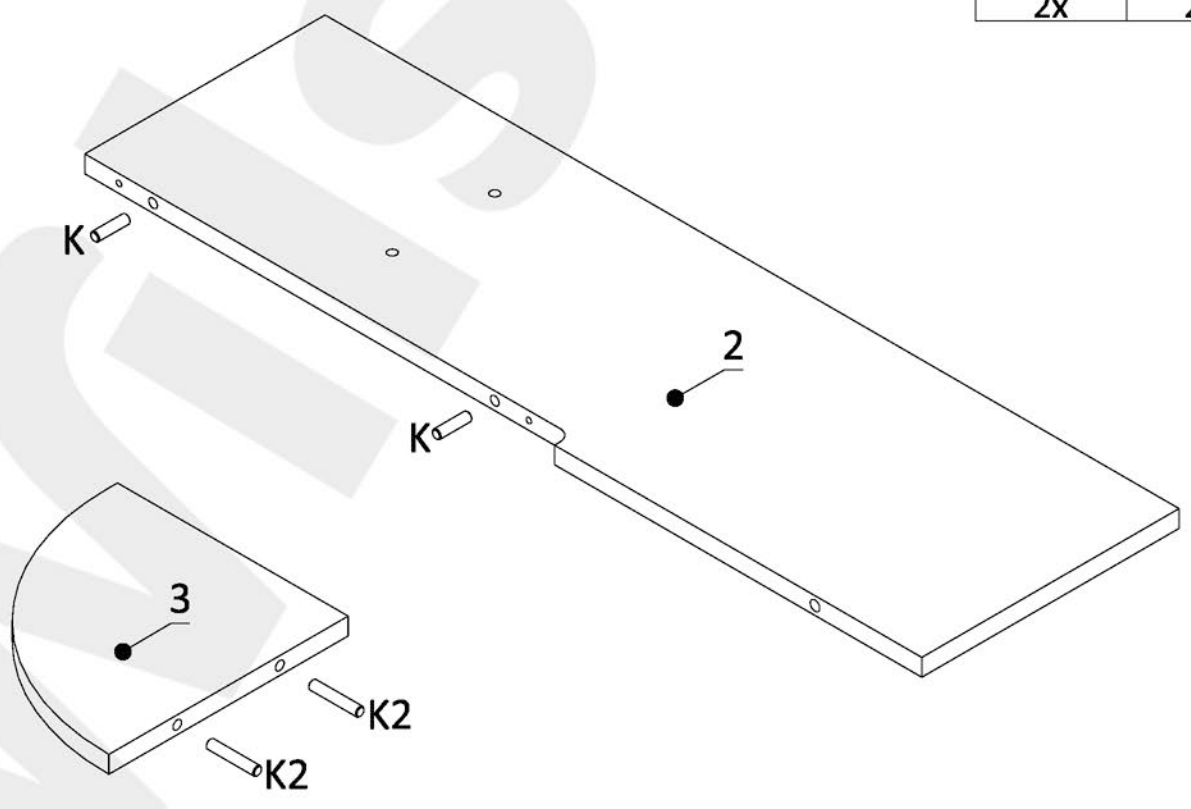

3

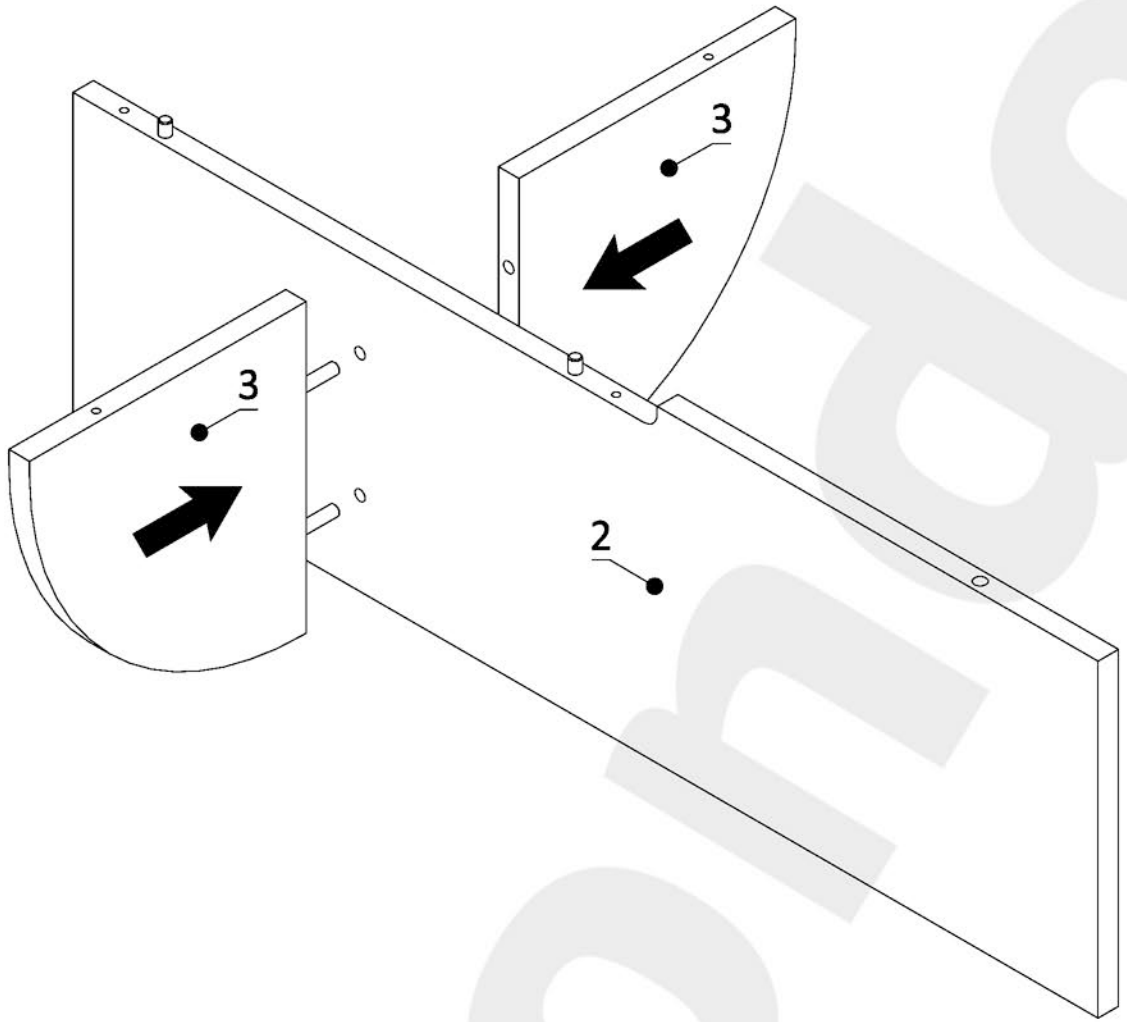

4

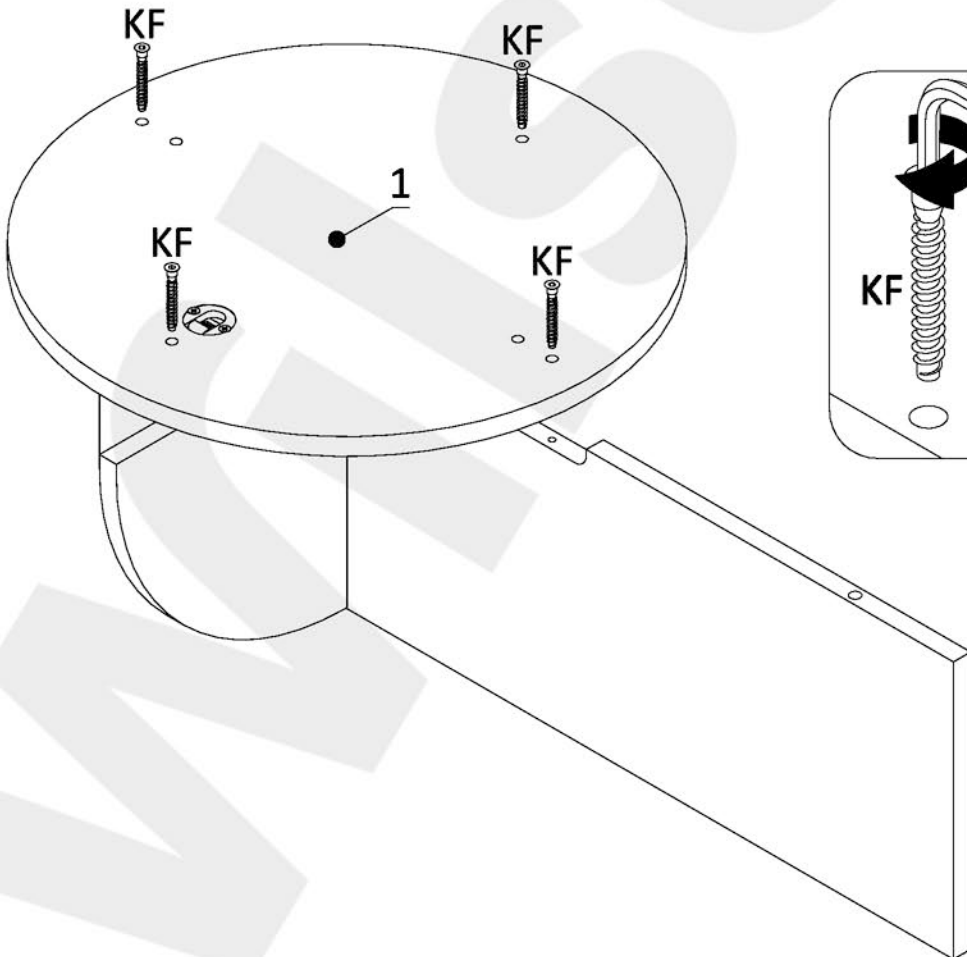

KL 1x	KF 4x

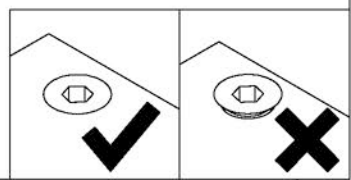

5

