











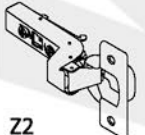

 8x30 K 19x	 15/12 M 16x	 L20,3 T 16x							
 4x16 W4 8x	 Z2 4x	 PZ 4x	 SL 4x	 P 12x	 ZM 16x	 Z5 8x	 2x20 G 12x	 S 7x	 PS 1x

1

	
K	M
8x	8x



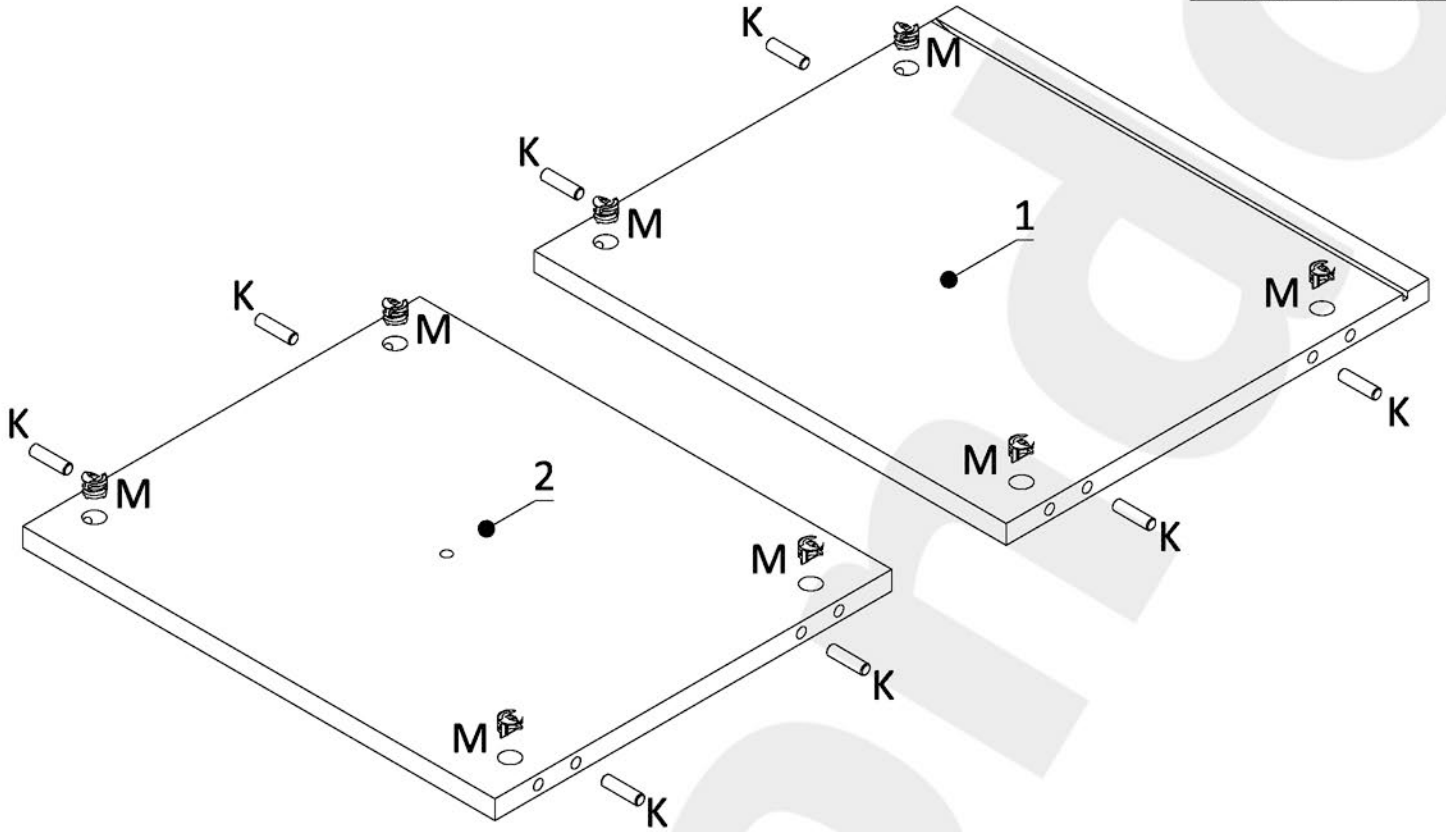

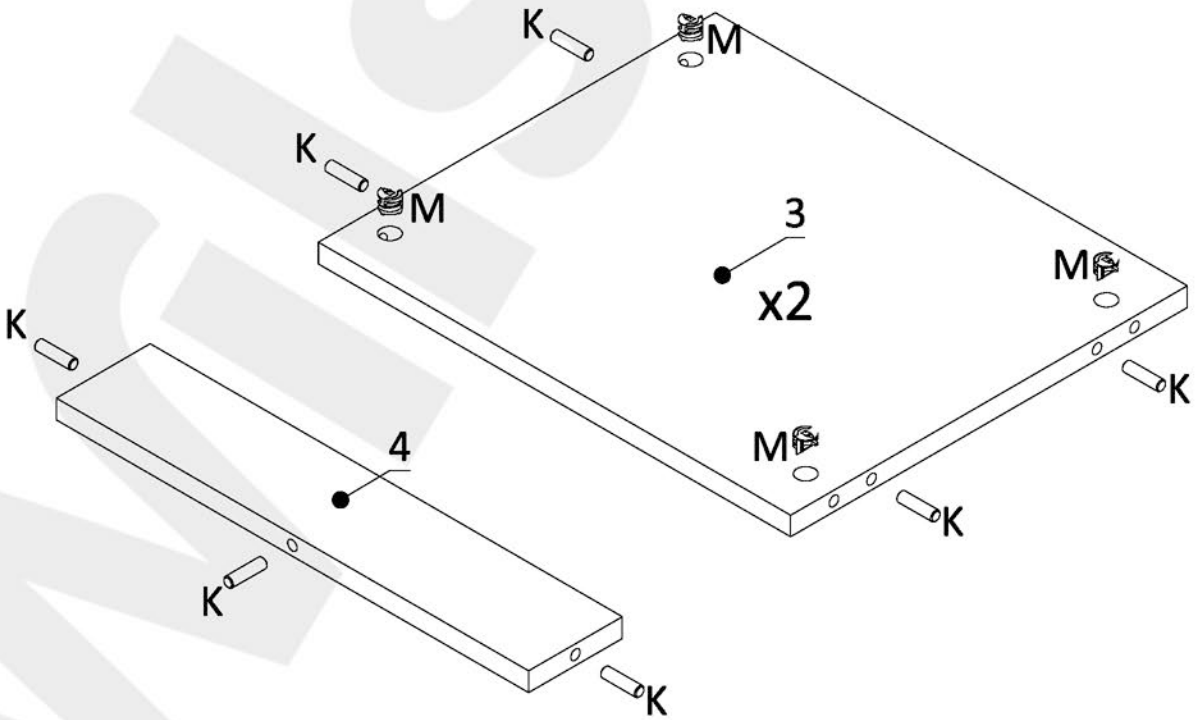

2

	
K	M
1x	8x

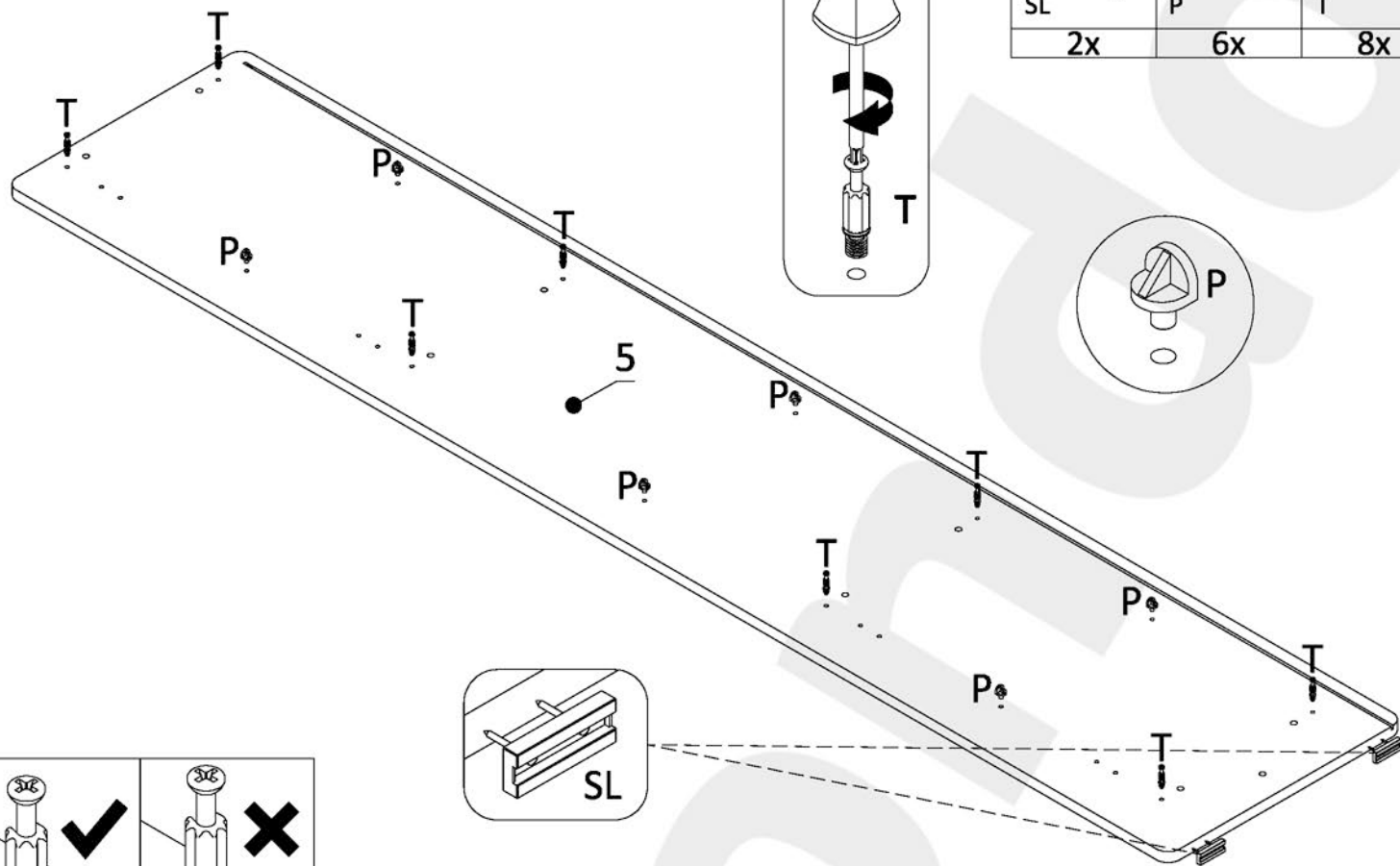





3

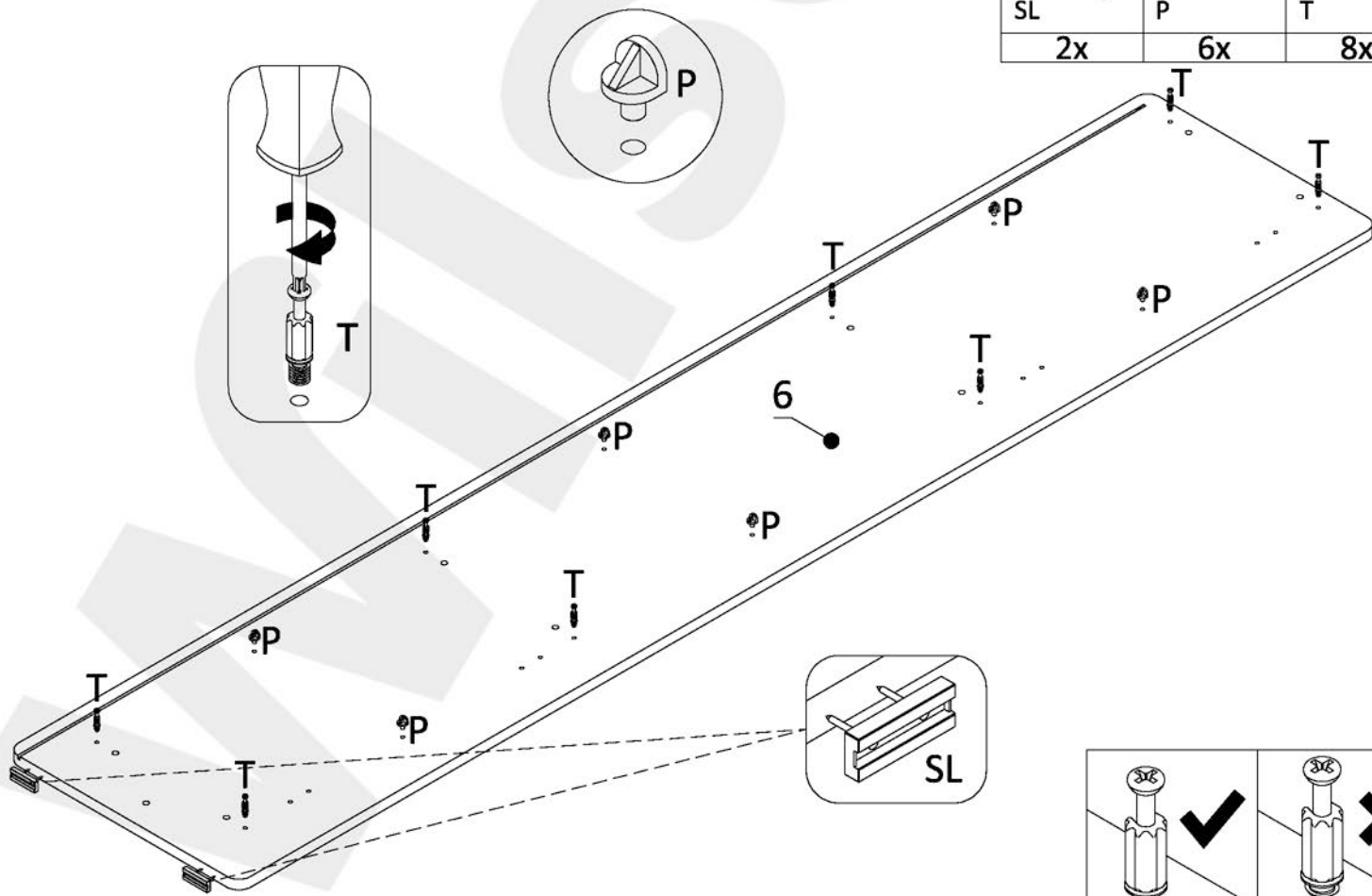

 SL	 P	 T
2x	6x	8x

4



 SL	 P	 T
2x	6x	8x

5 Option L

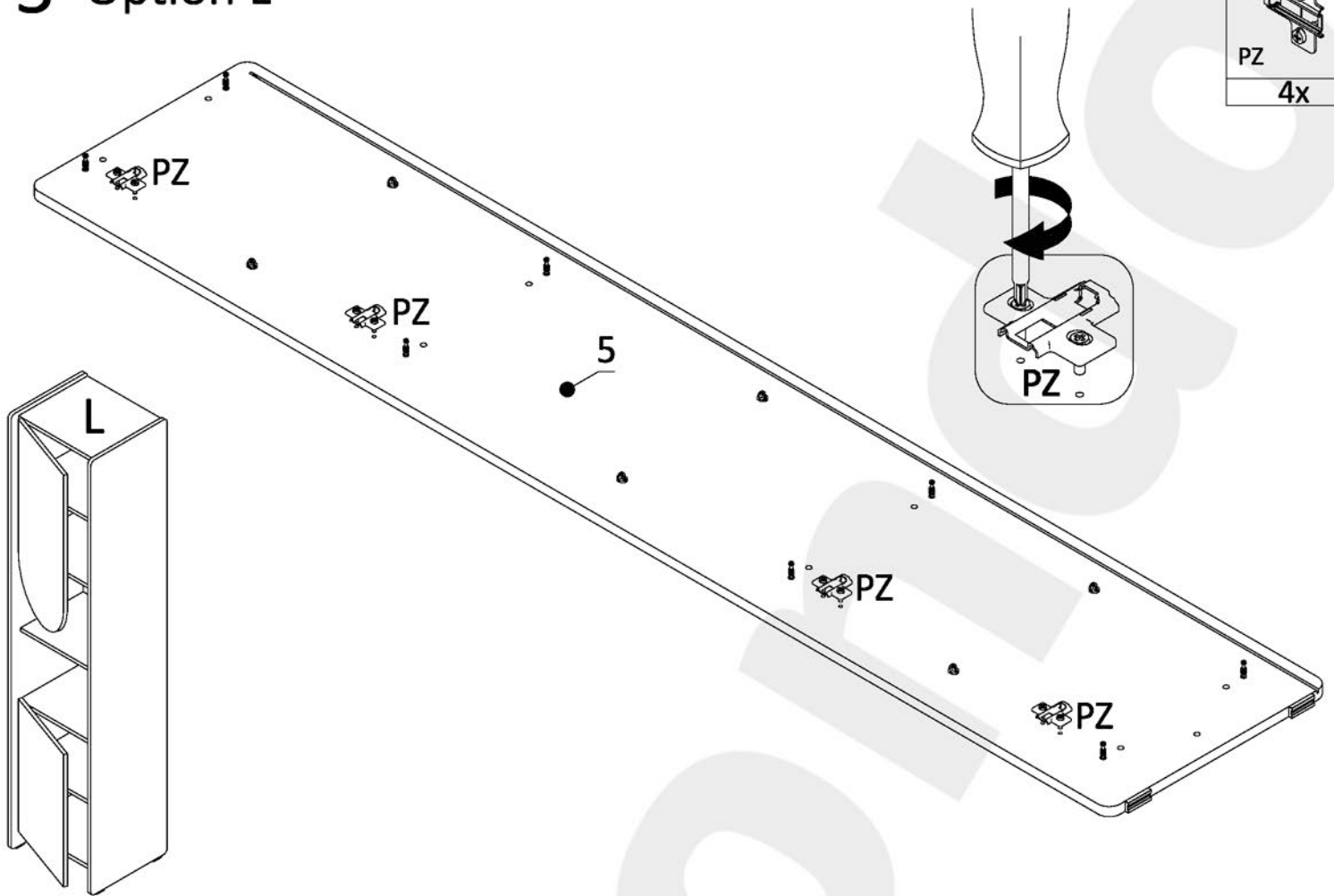

5 Option R

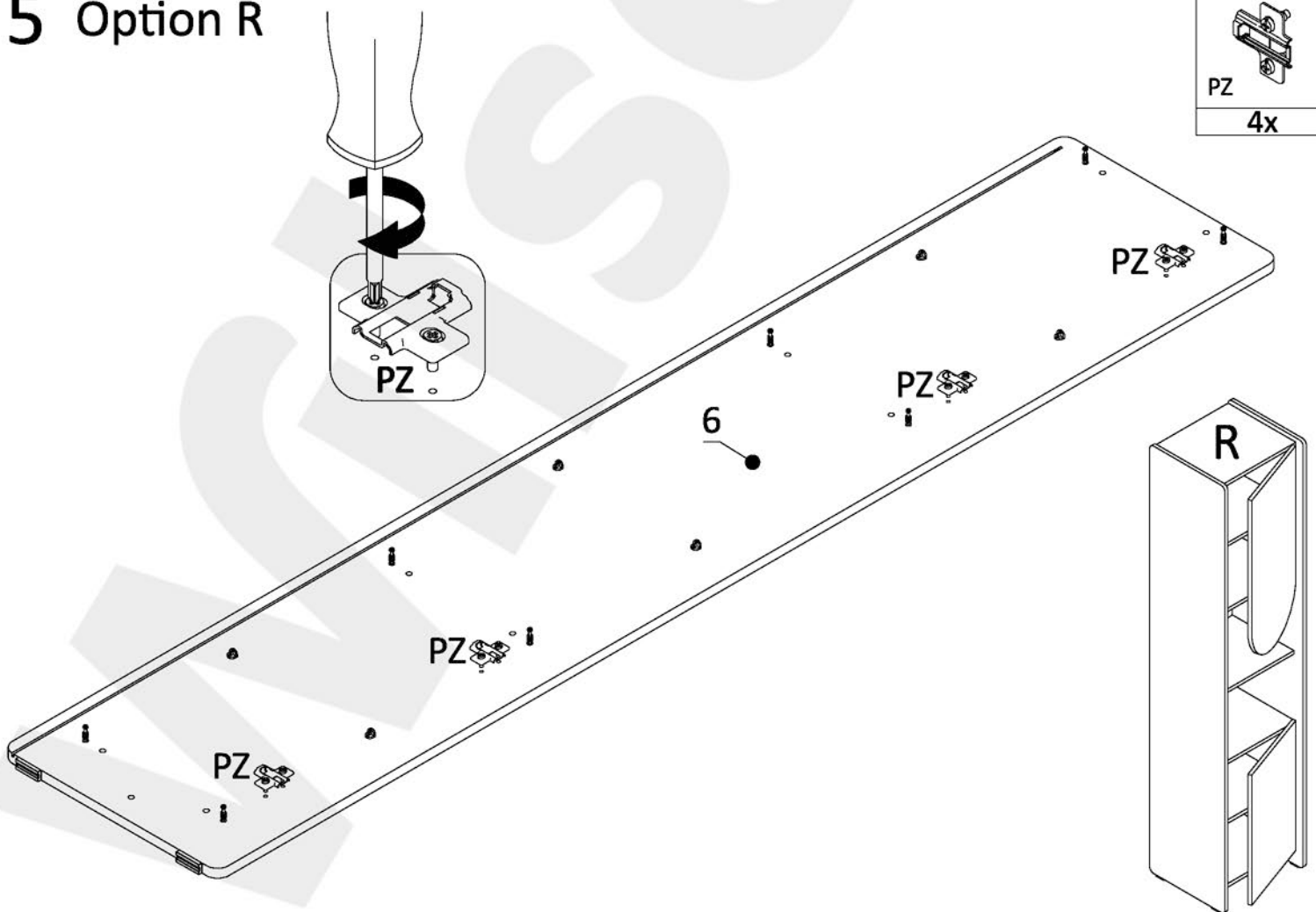

6 Option L

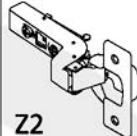
	
W4 4x	Z2 2x

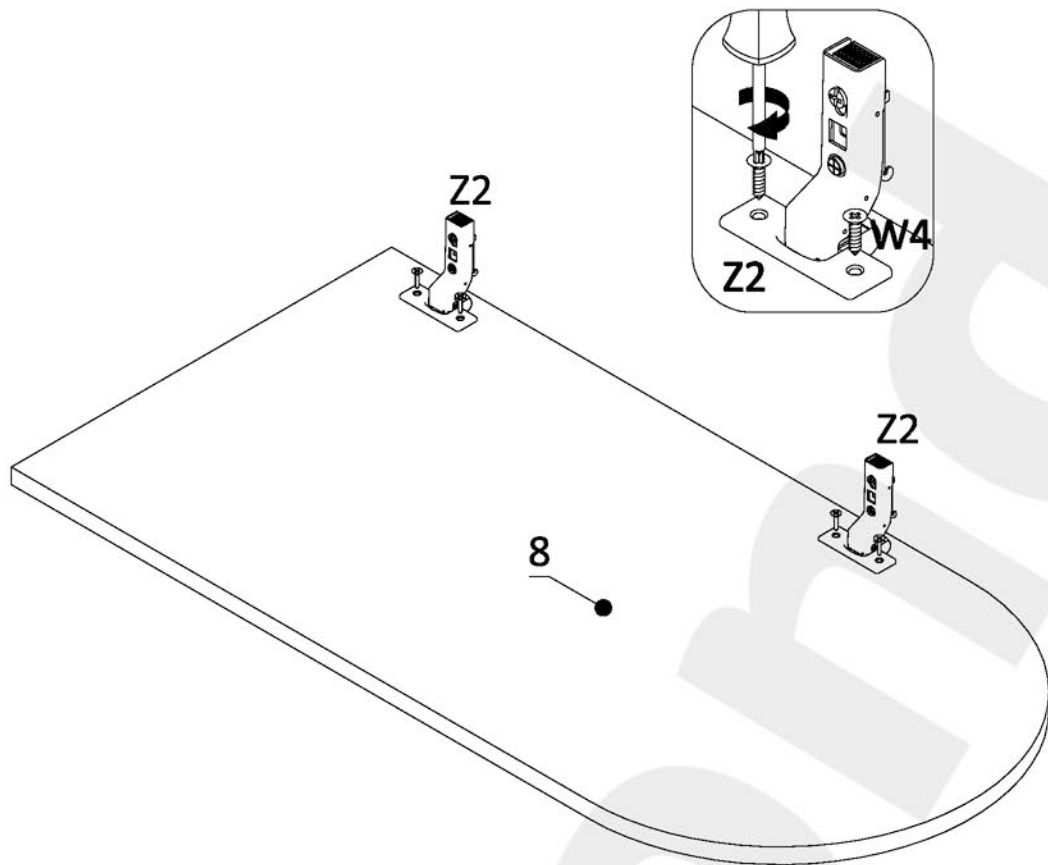

6 Option R

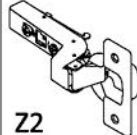
	
W4 4x	Z2 2x

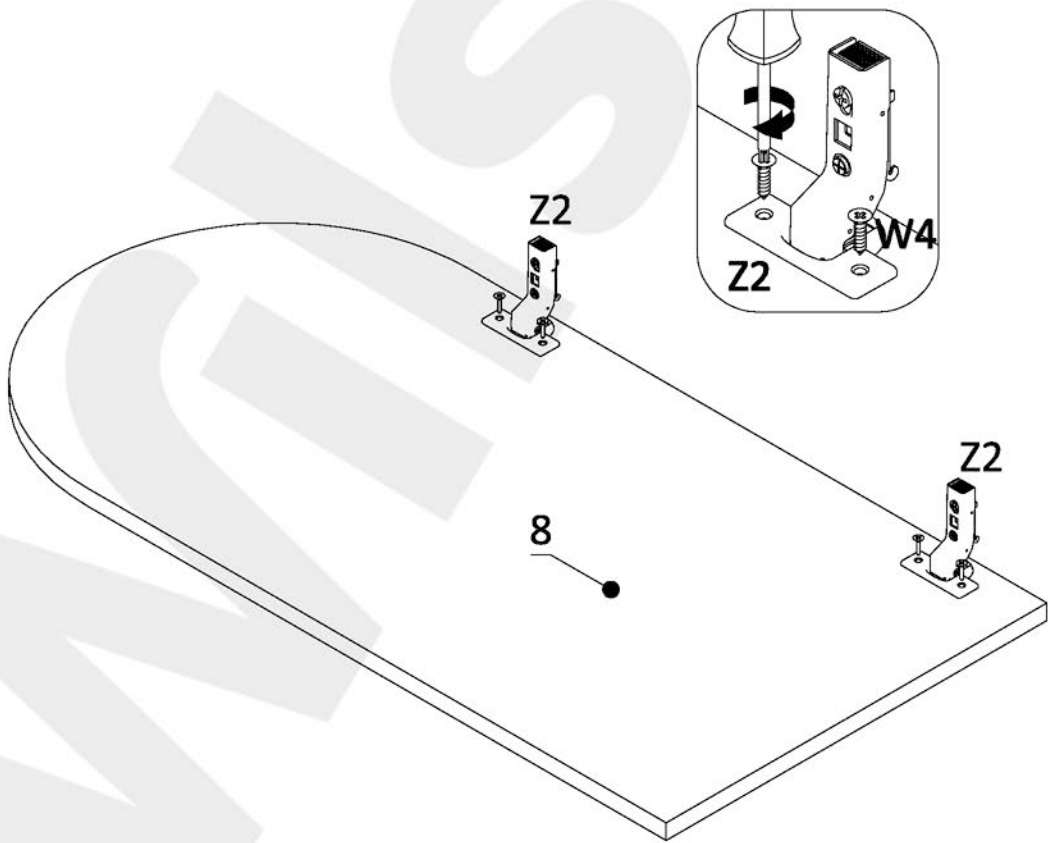

7

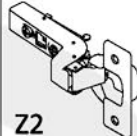
	
W4	Z2
4x	2x

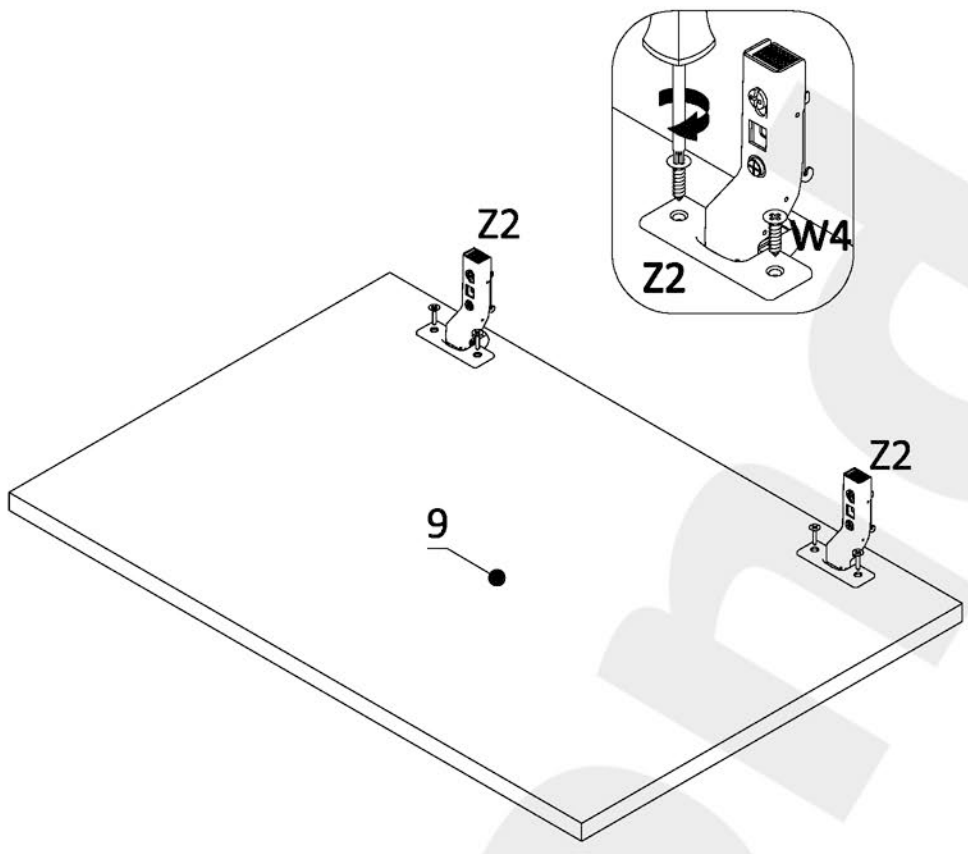

8

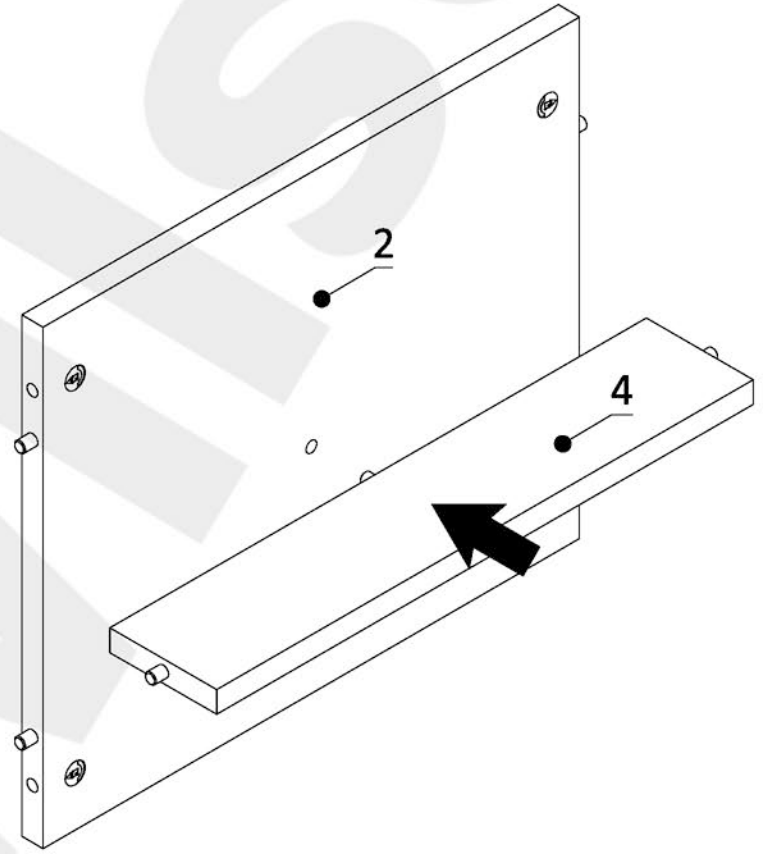

9

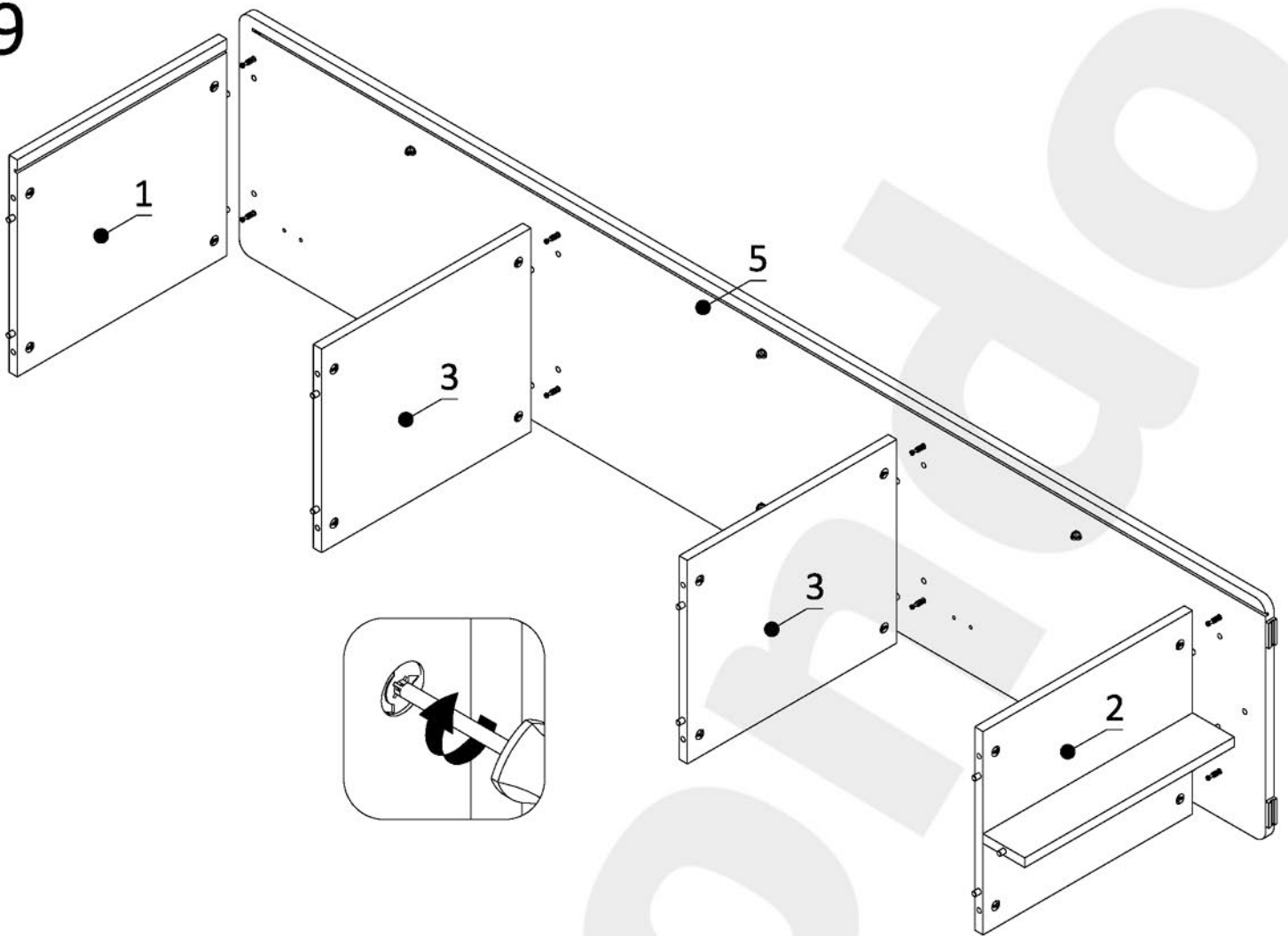

10

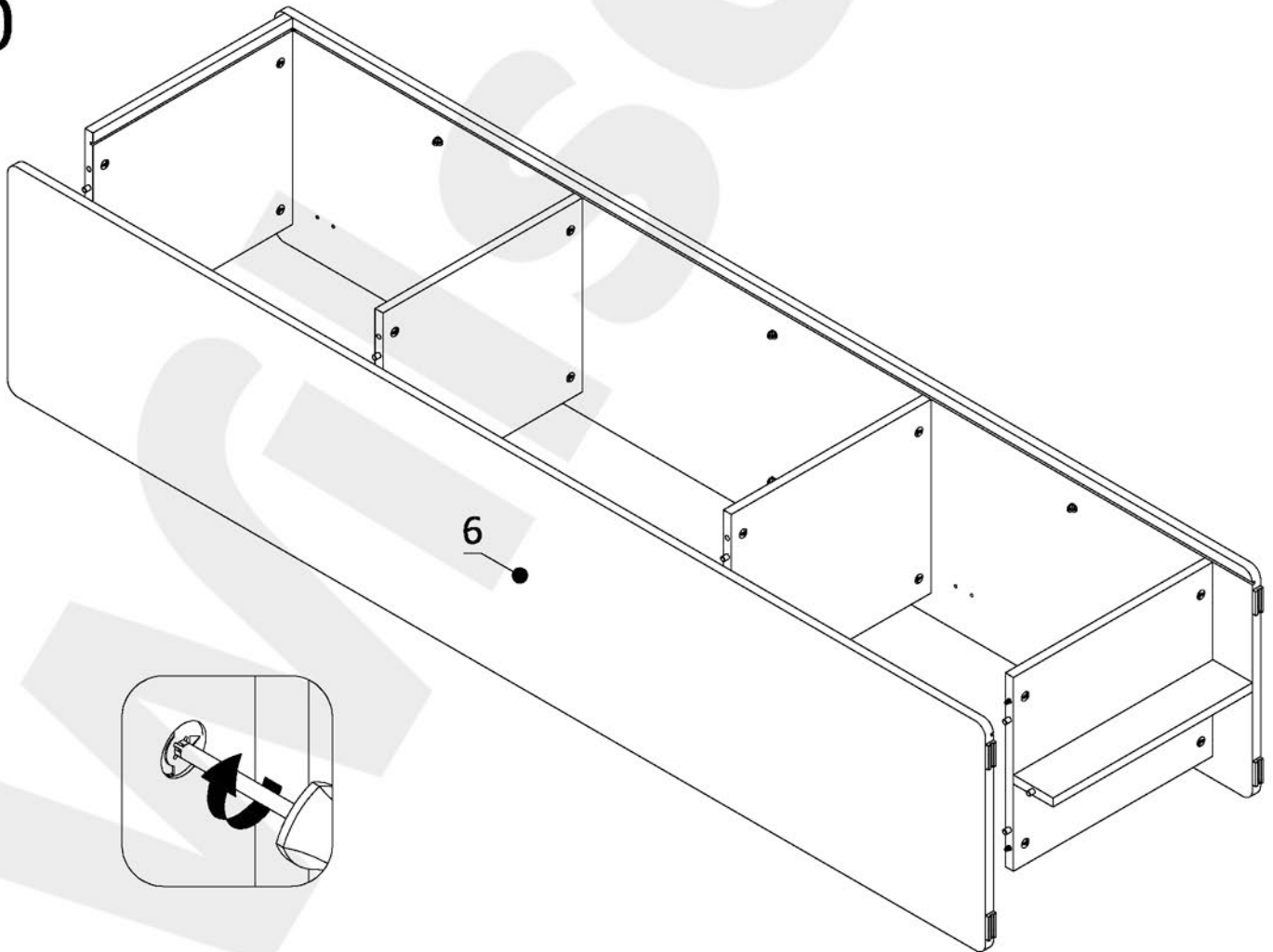

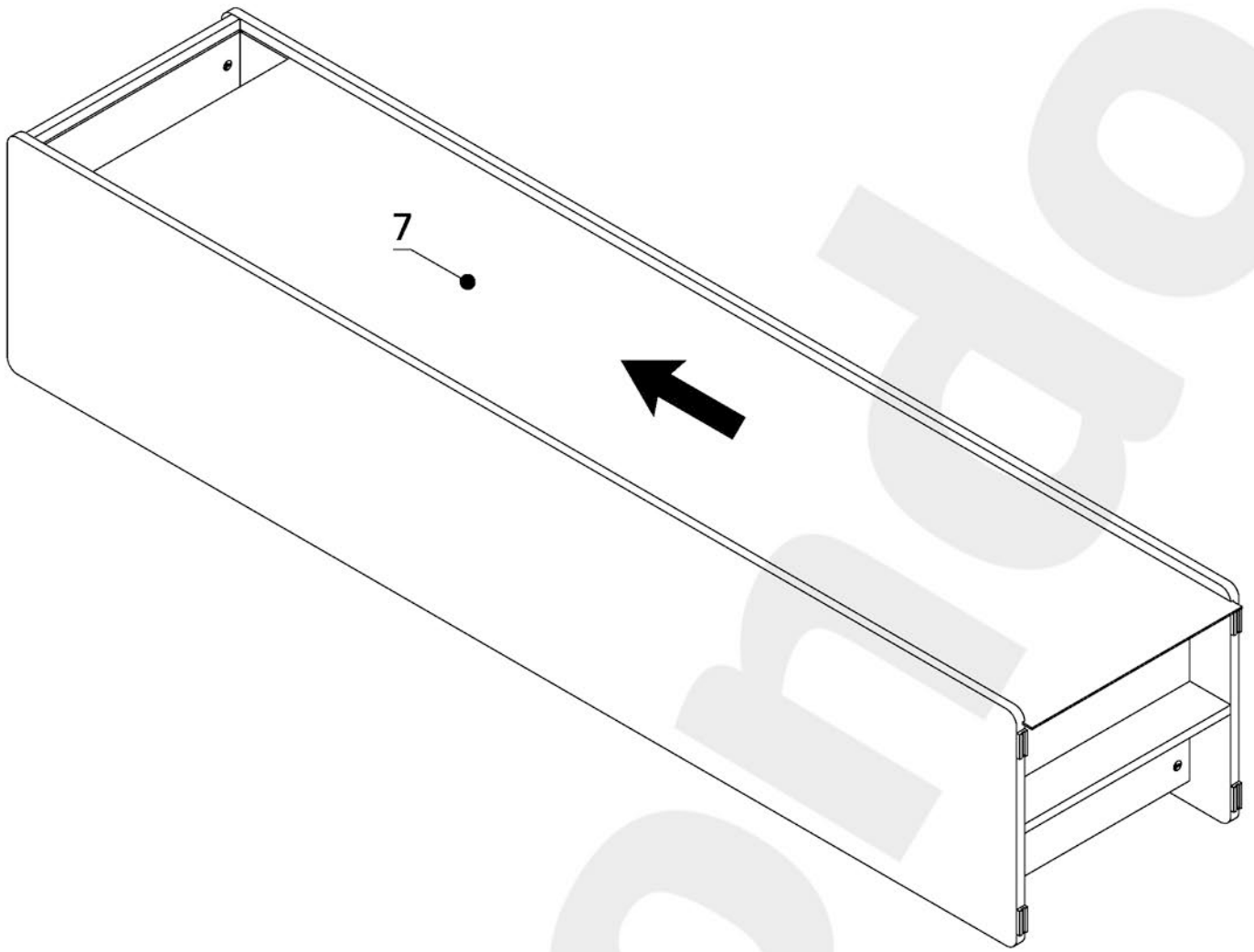

11

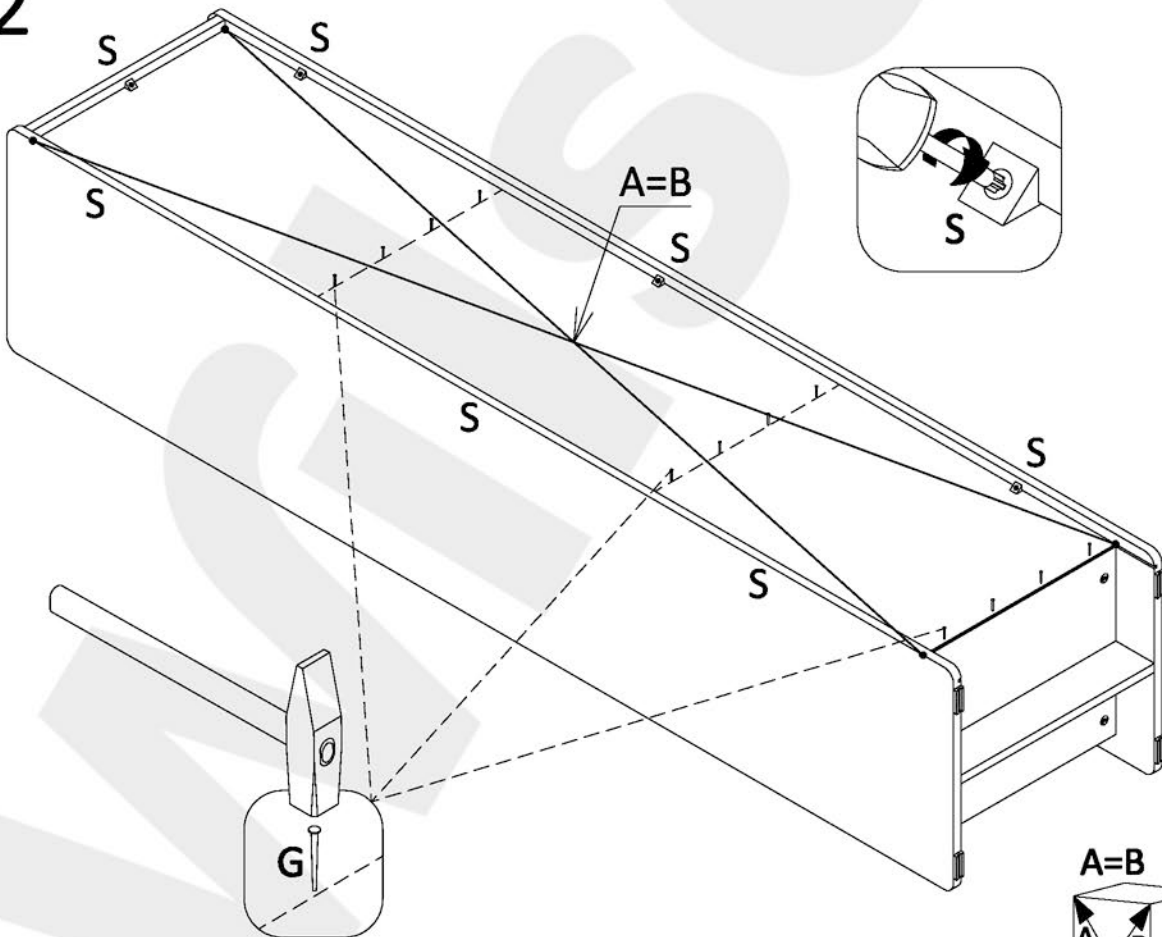

12



 G 12x	 S 7x
---	--

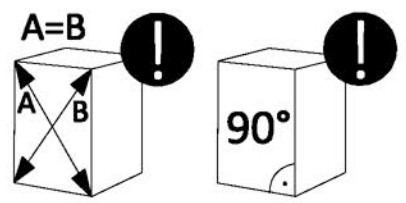

13

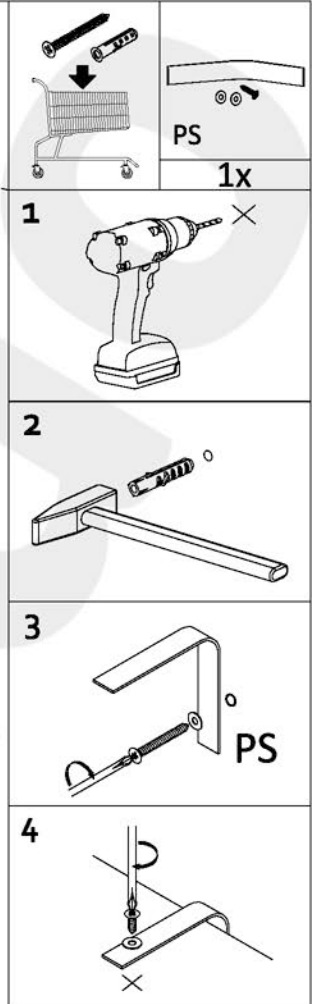
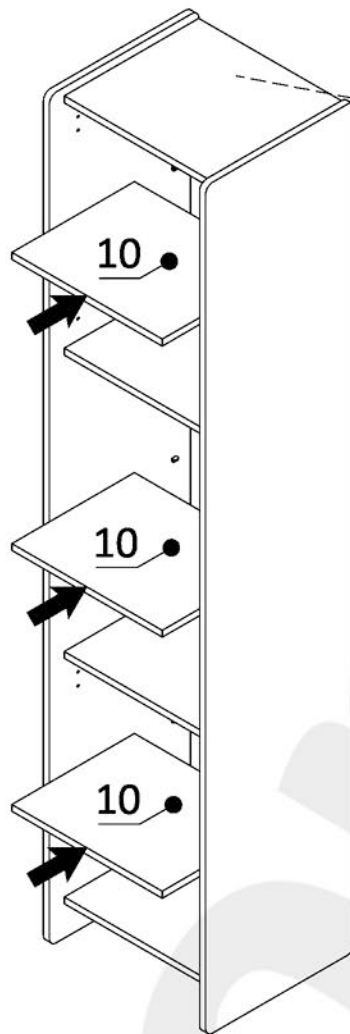
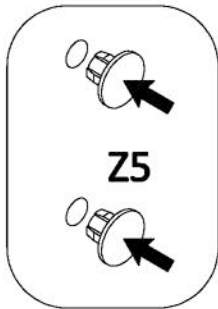

14

