

# LUCA LC 3

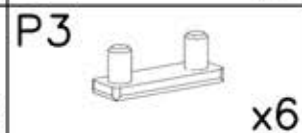

I

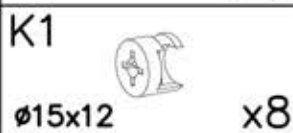
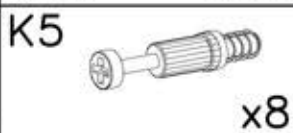
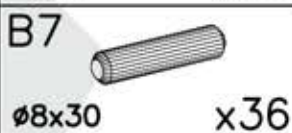
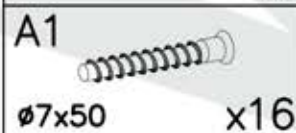
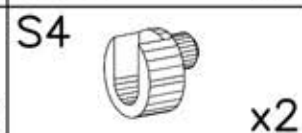
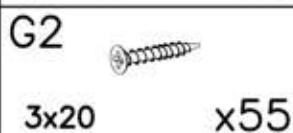
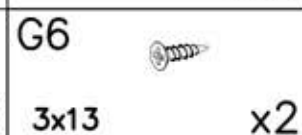
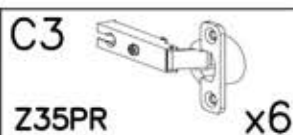
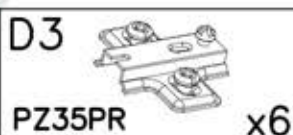
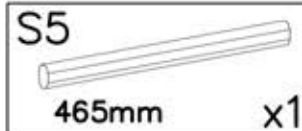
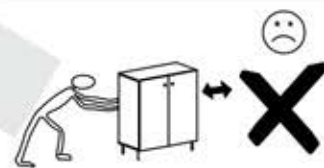
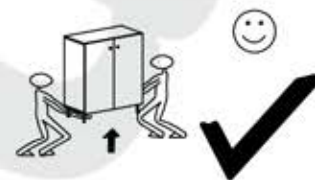
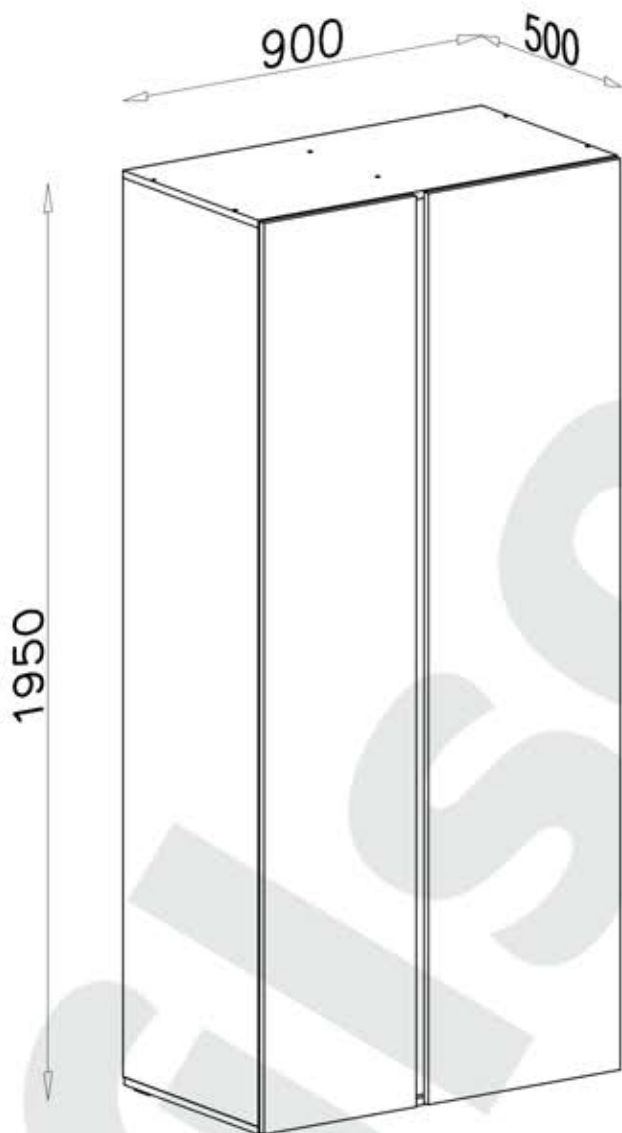
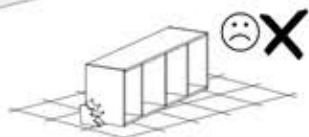
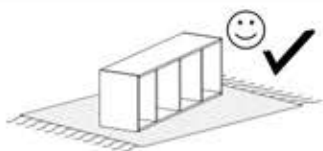
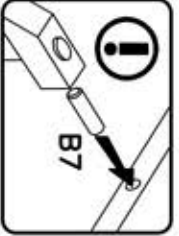
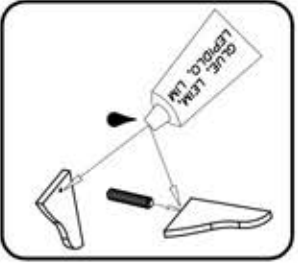
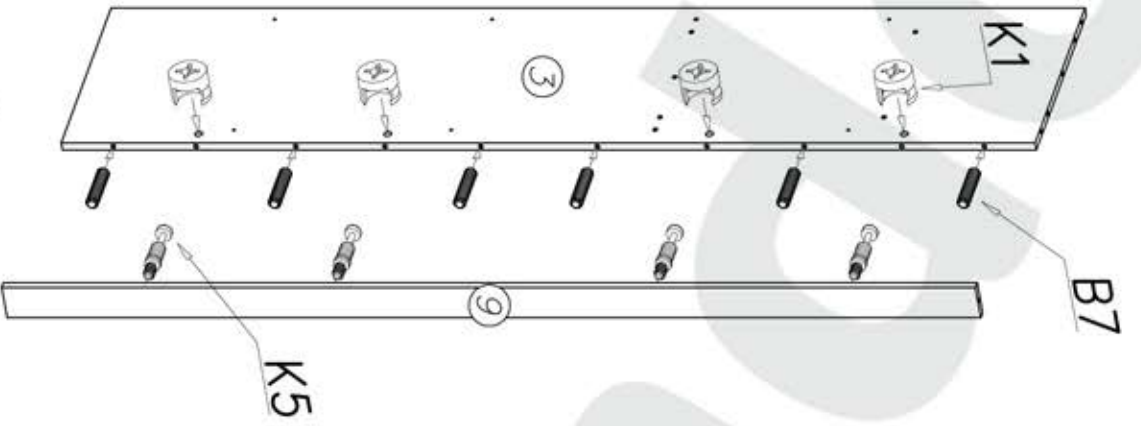

II

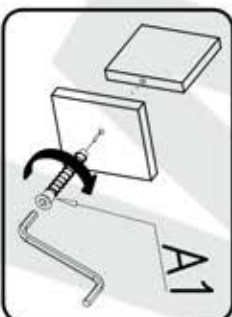
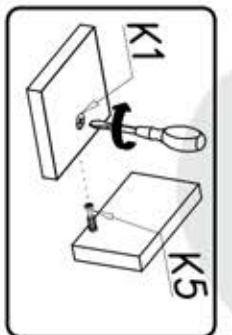
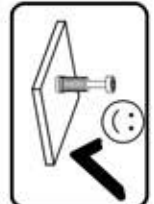
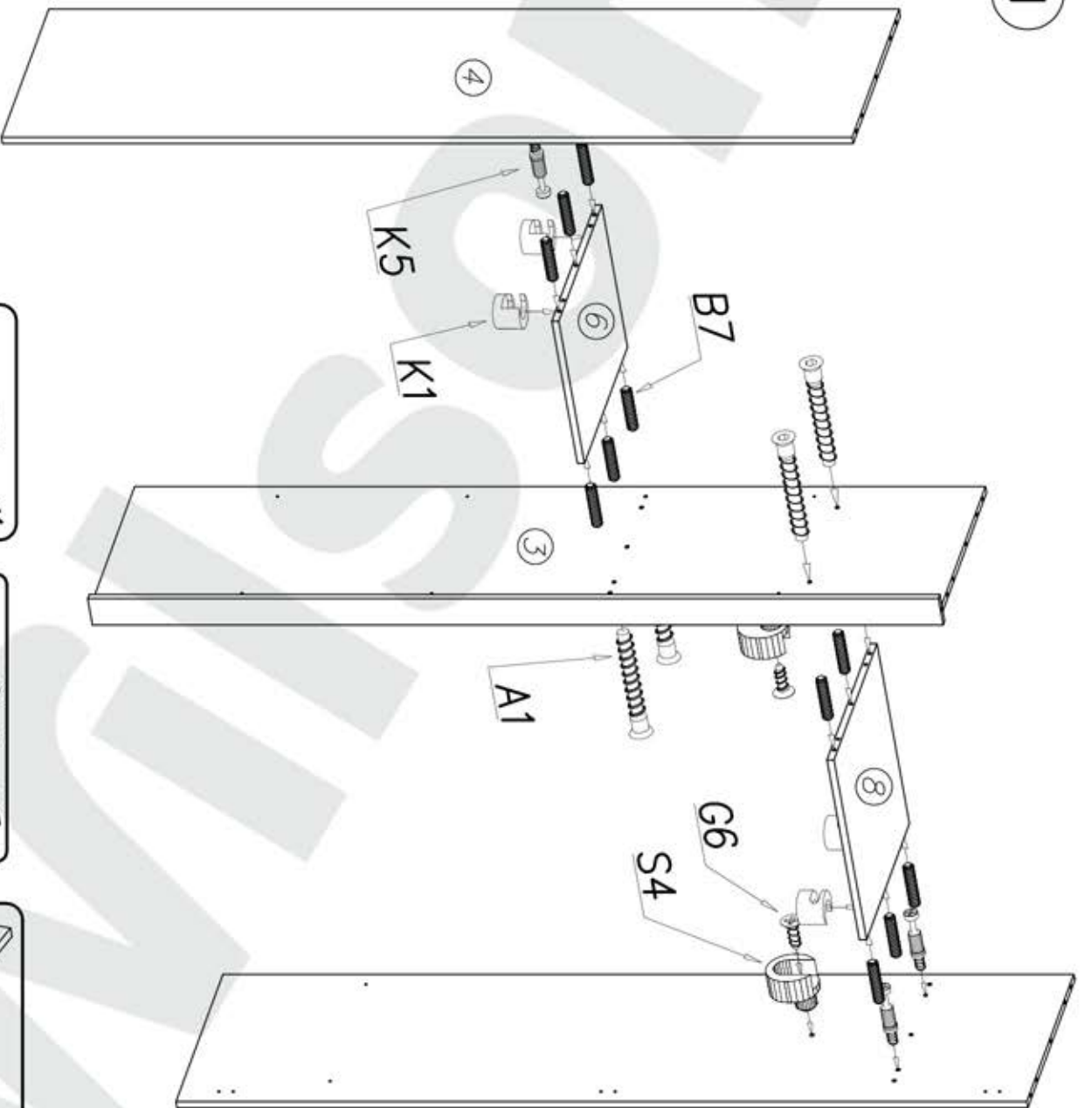

III

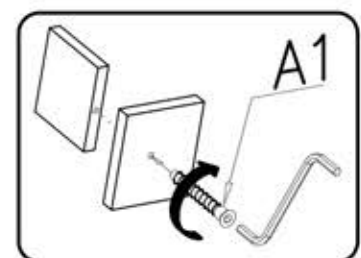
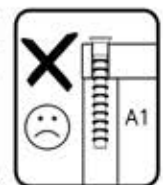
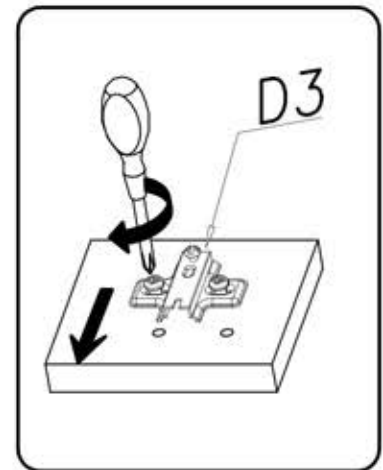
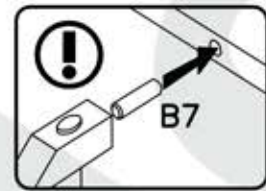
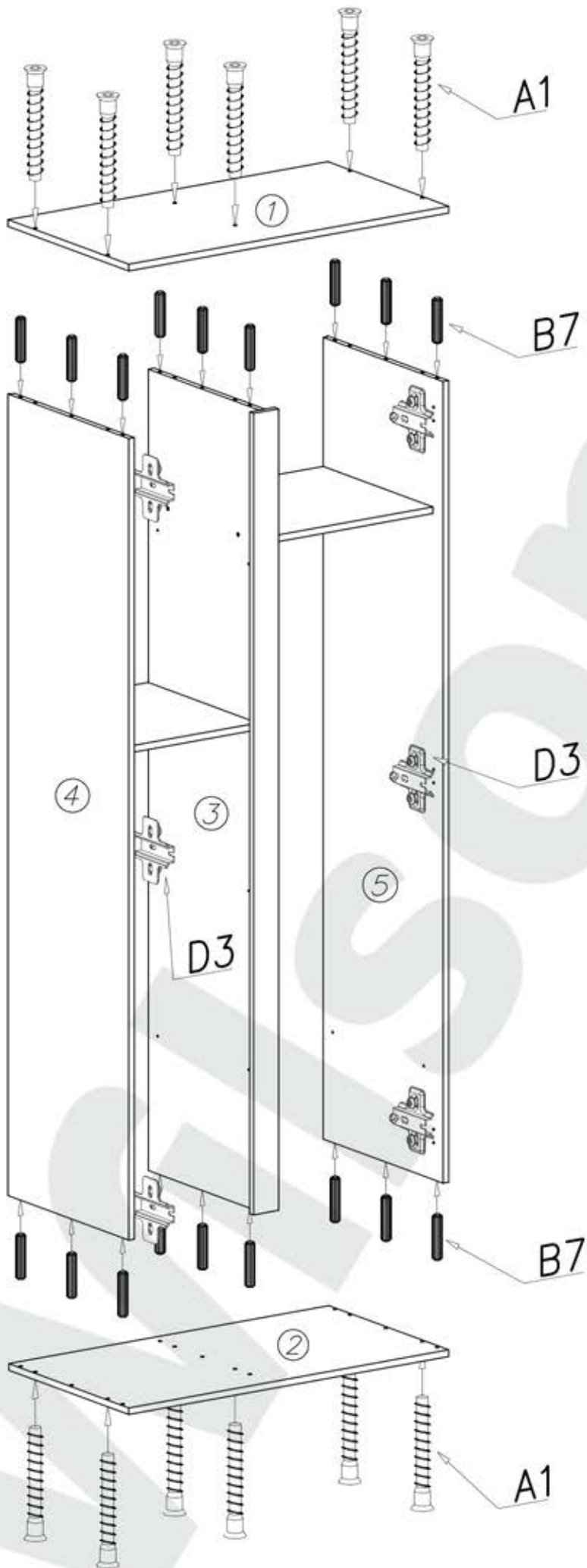

IV

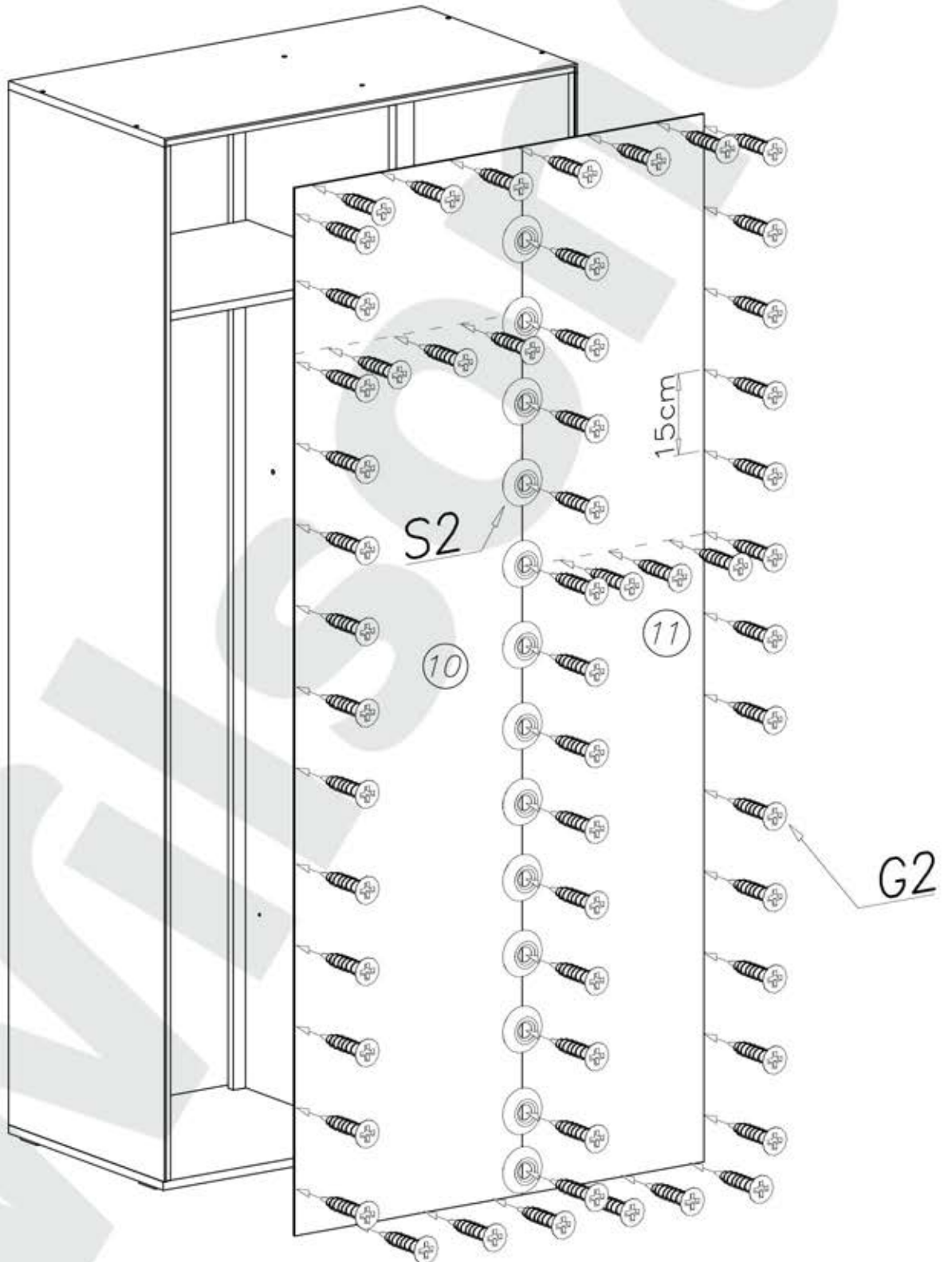
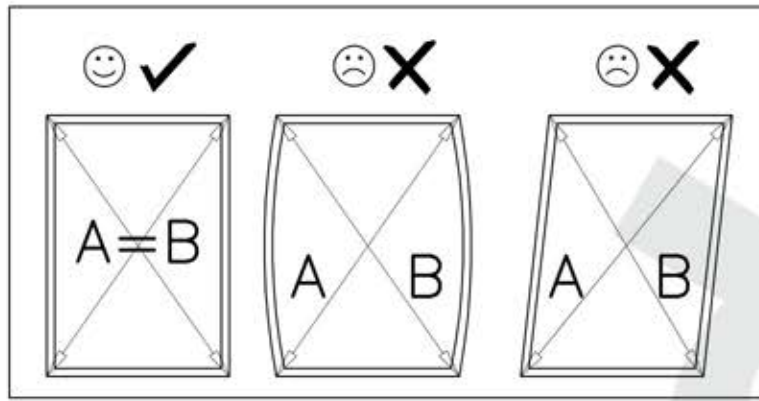

P3

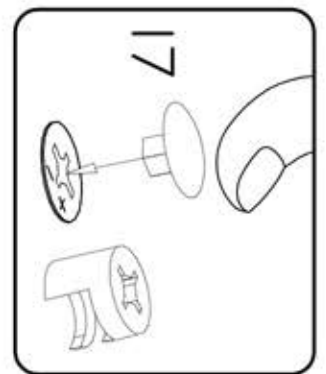
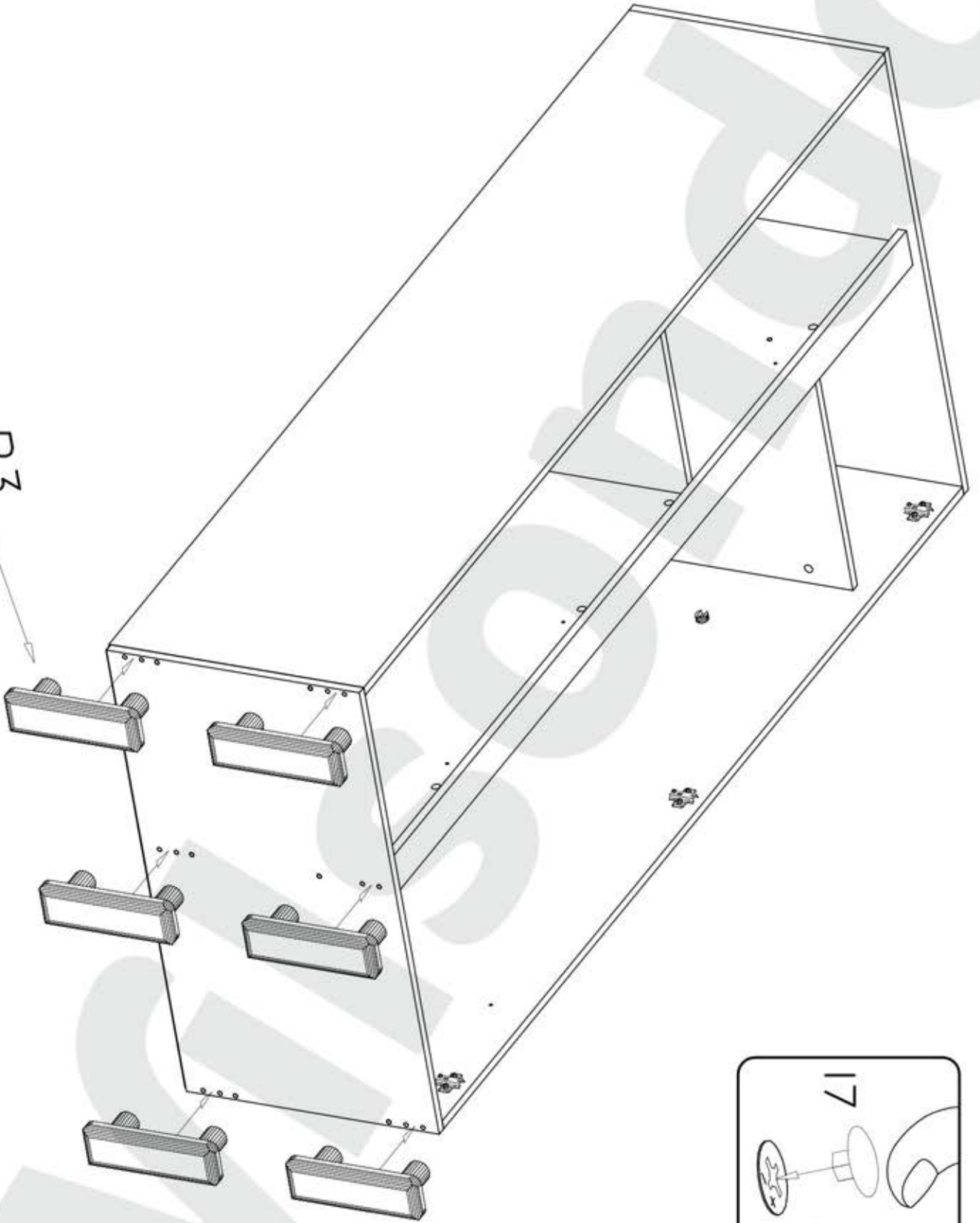

VI

