

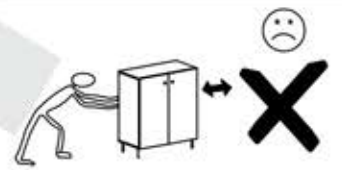

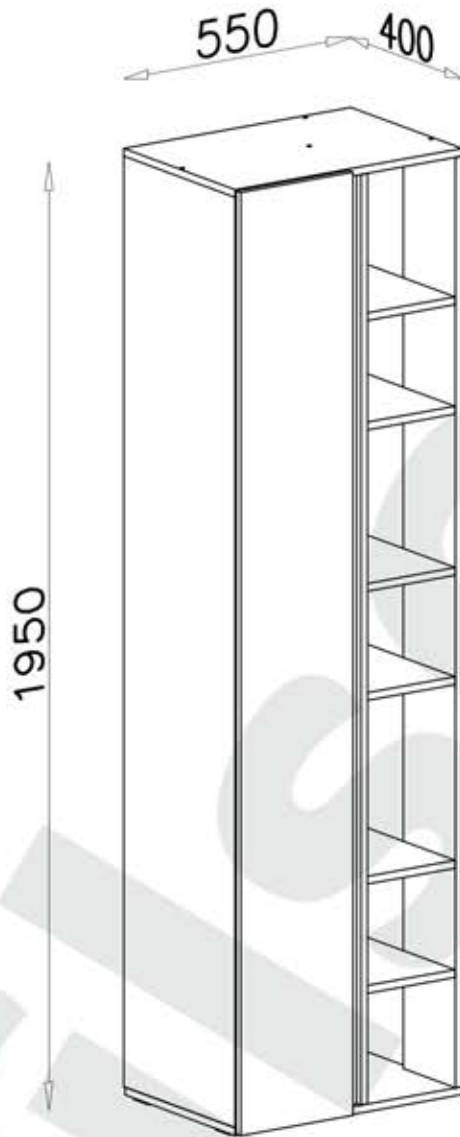

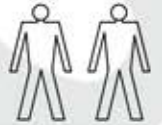

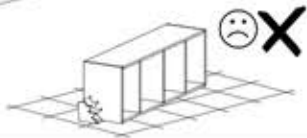

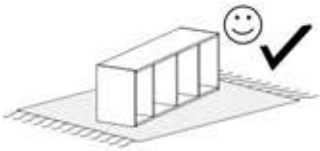

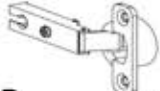

LUCA LC 4

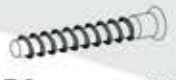

I7  ø18 x14	W1  GLUE, LEIM, LEPIDLO, LIM x3	D3  PZ35PR x3	C3  Z35PR x3
W2  x1	G4  4x16 x6	G2  3x20 x35	F1  x12
A1  ø7x50 x25	B7  ø8x30 x62	K5  x14	K1  ø15x12 x14
			P3  x6

1

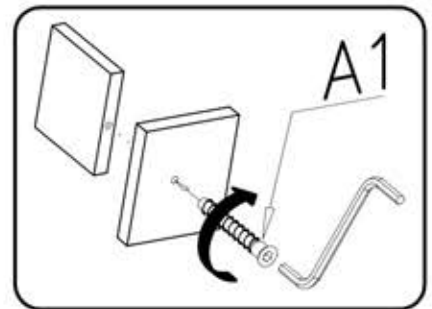
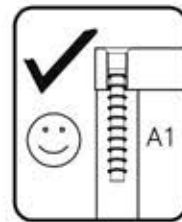
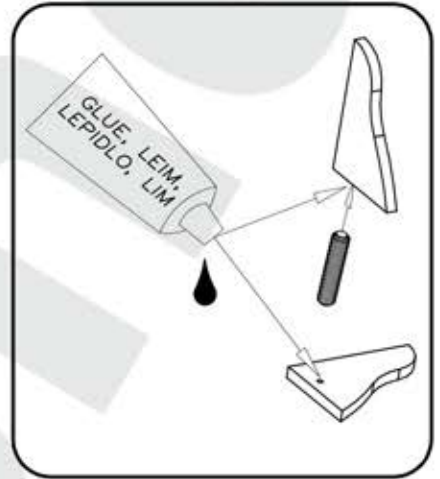
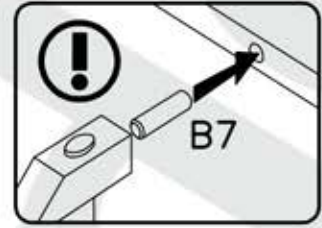
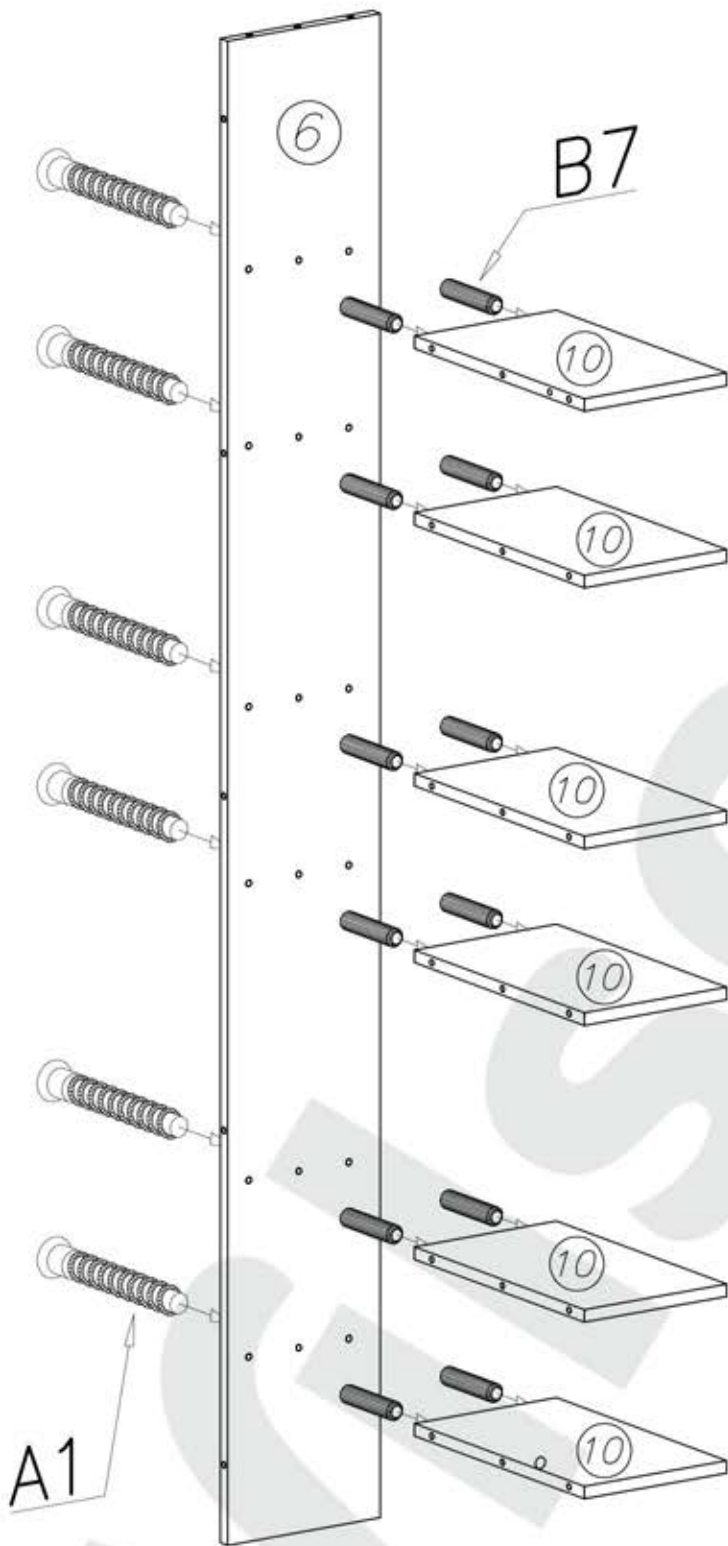

II

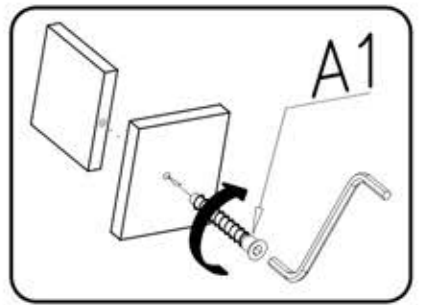
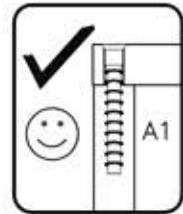
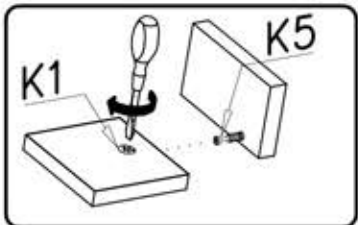
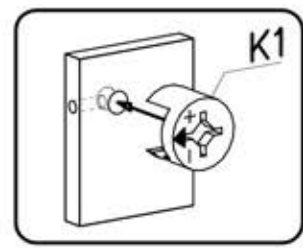
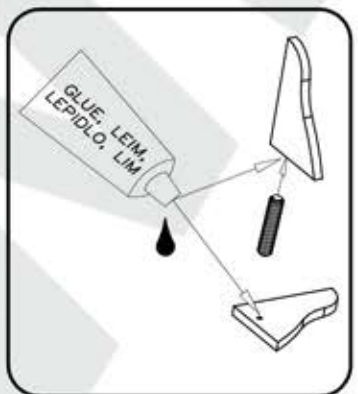
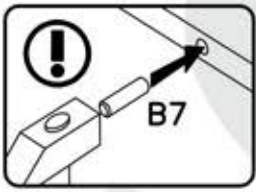
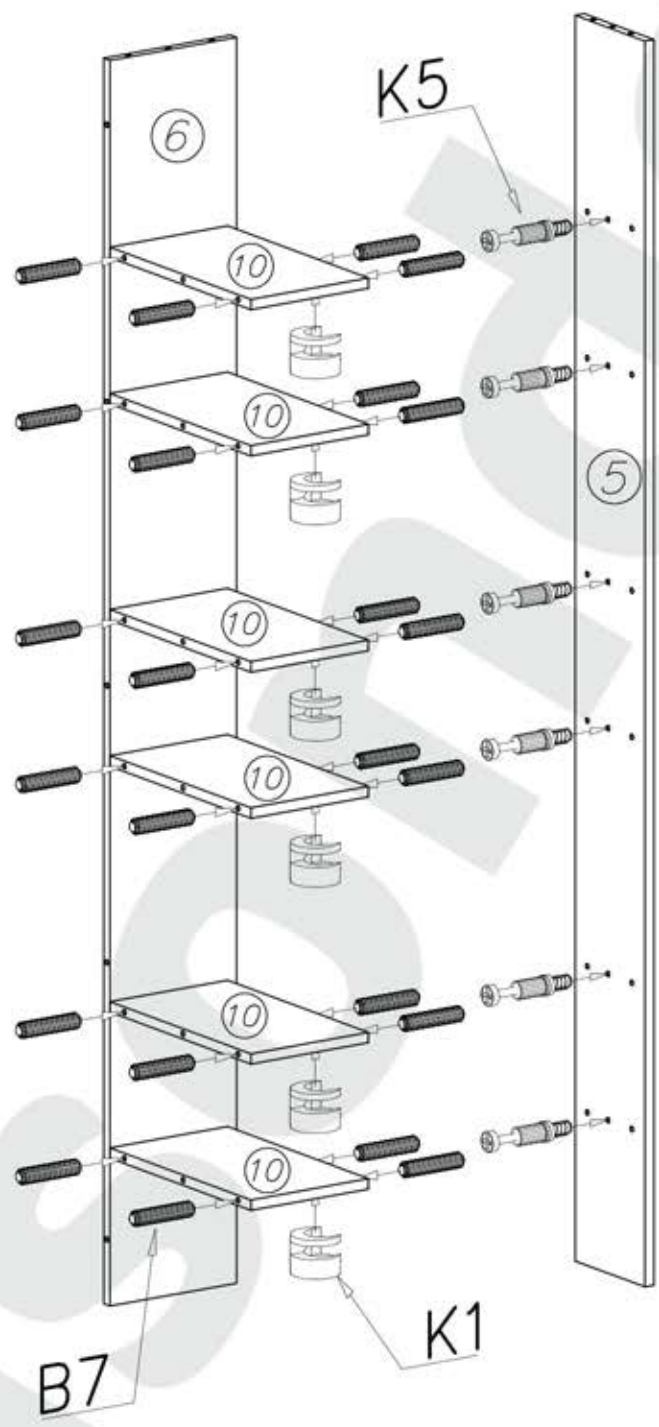
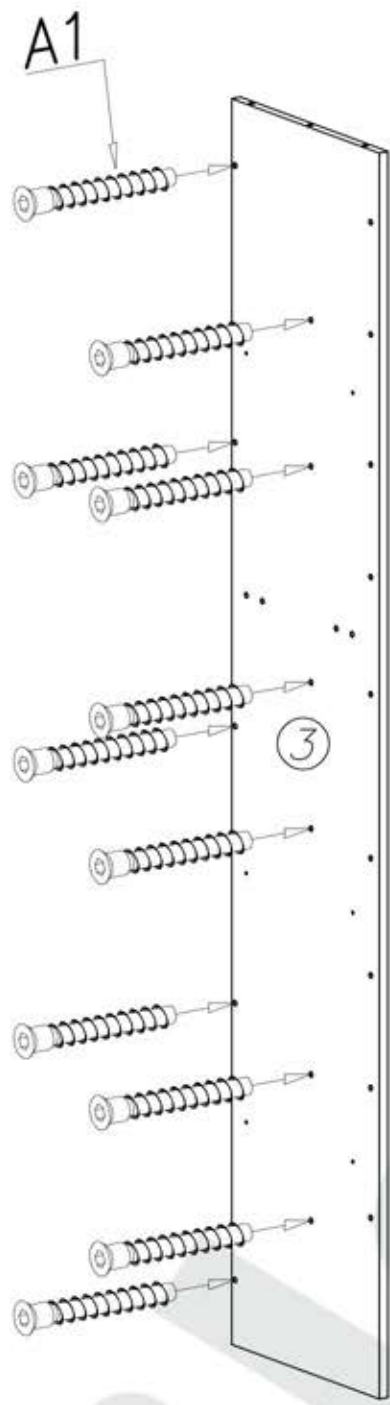

III

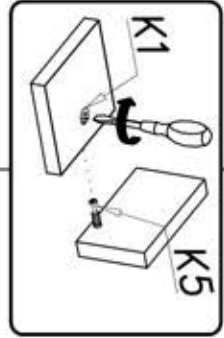
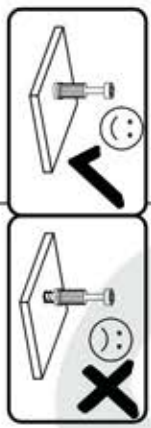
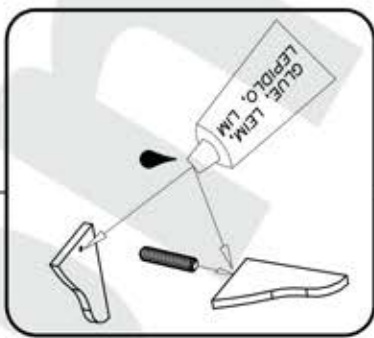
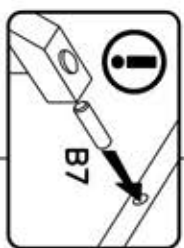
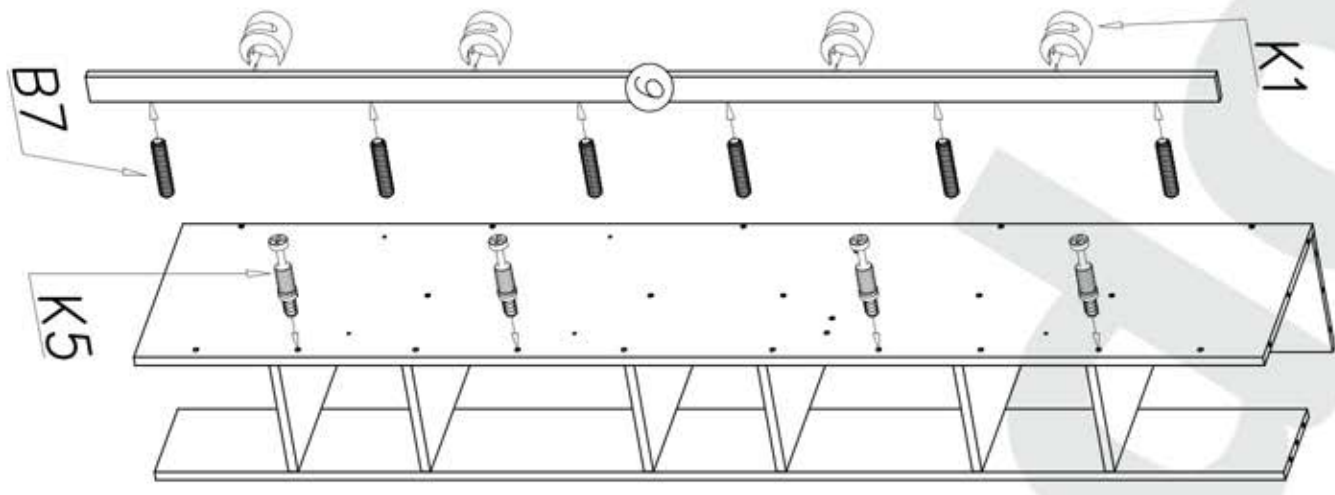

IV

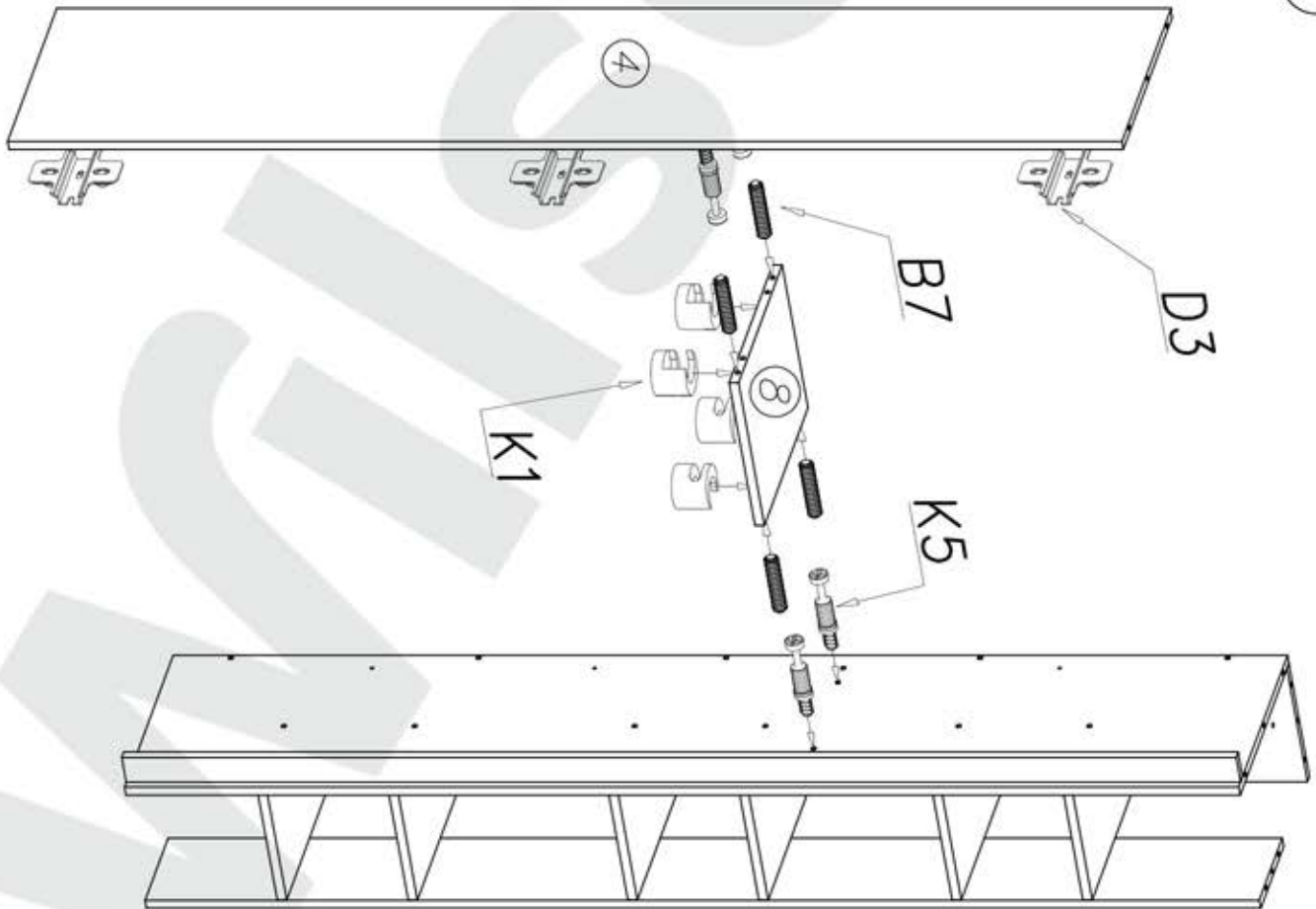

V

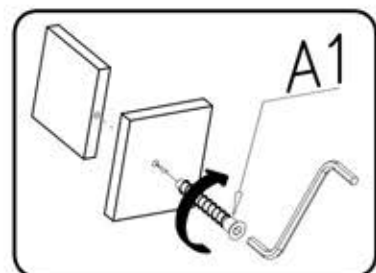
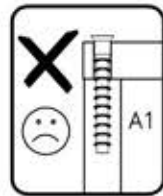
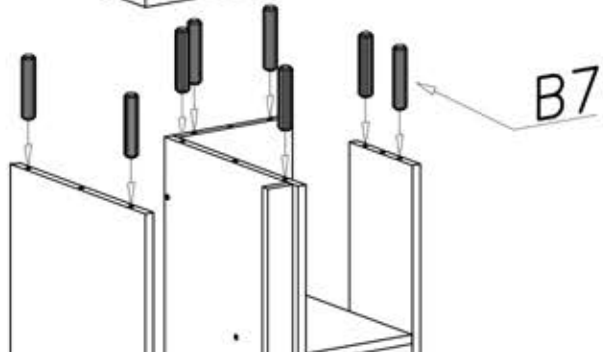
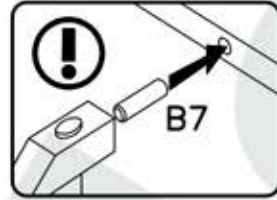
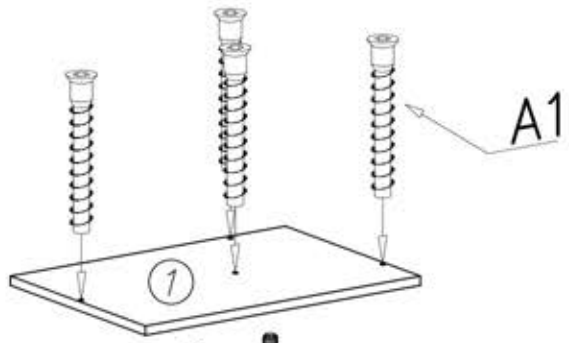

VI

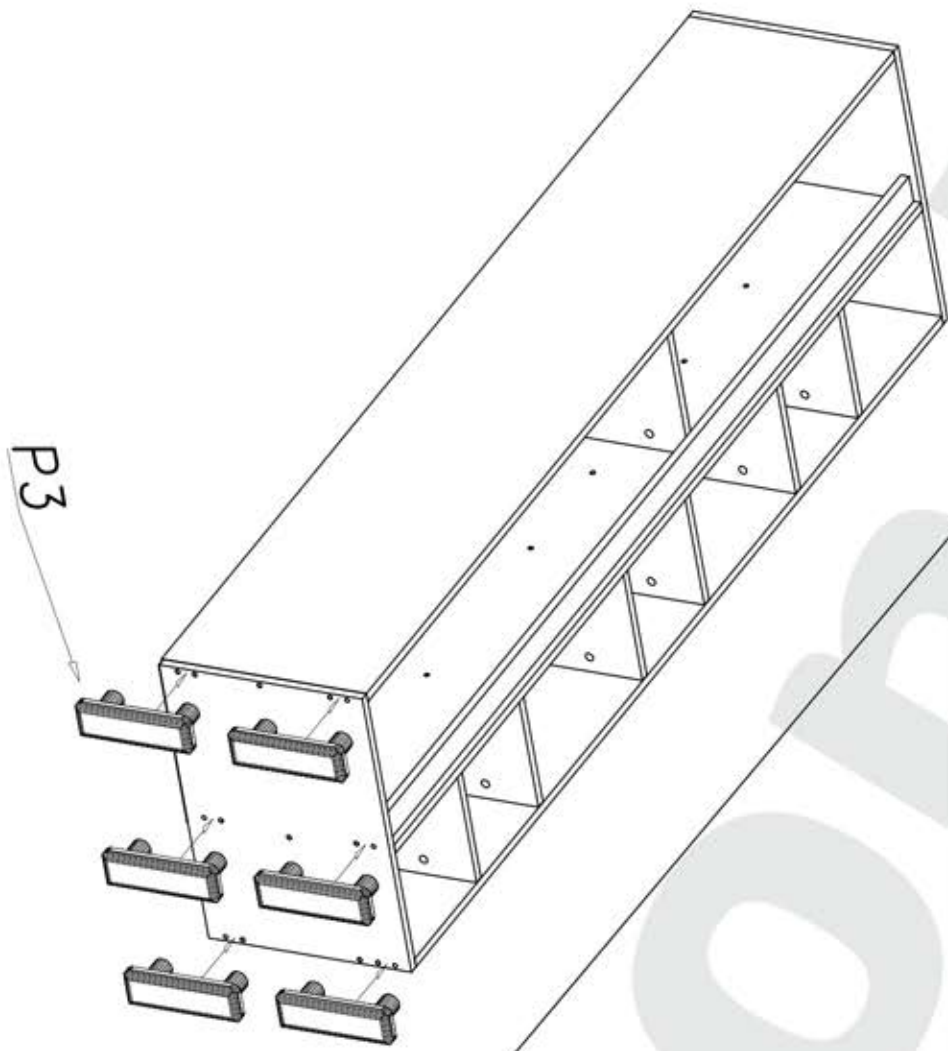

VII

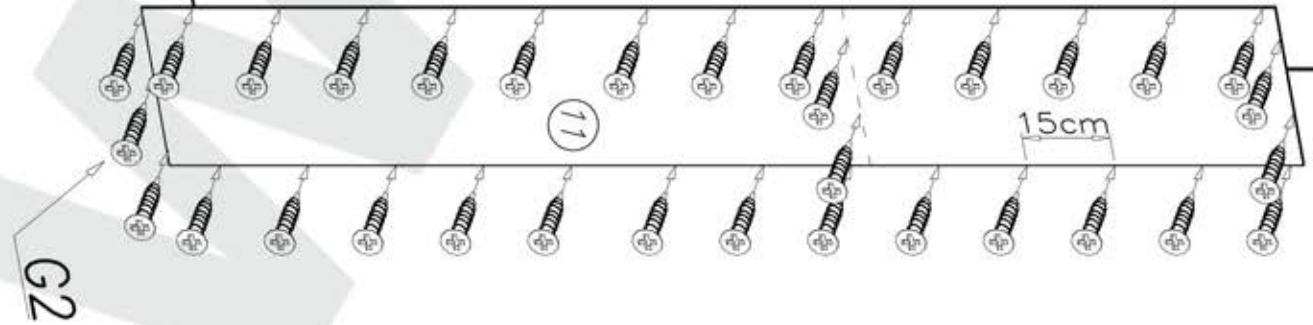
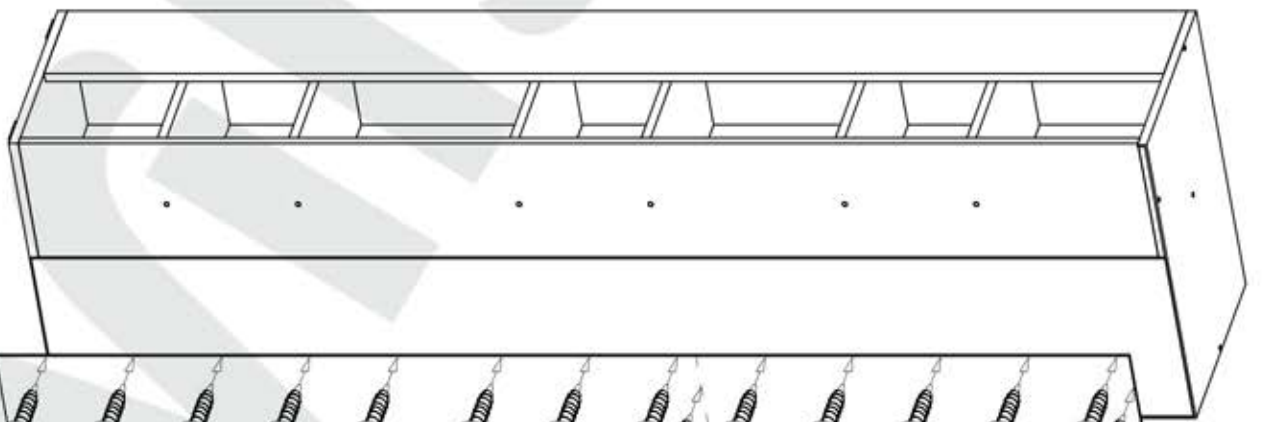
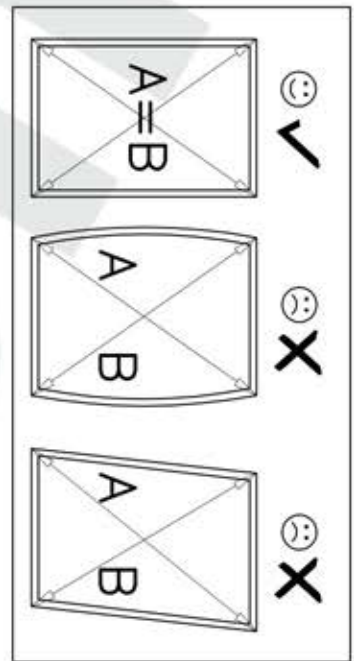

VIII

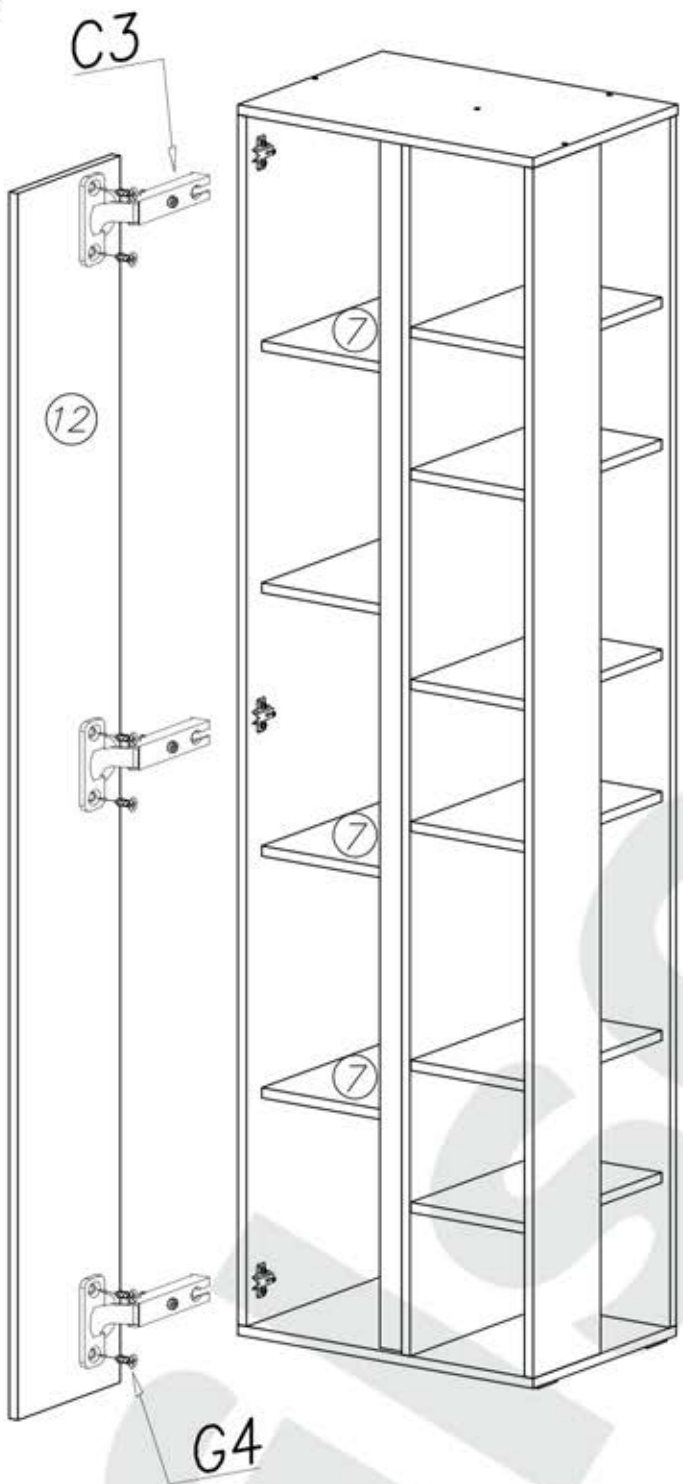

1

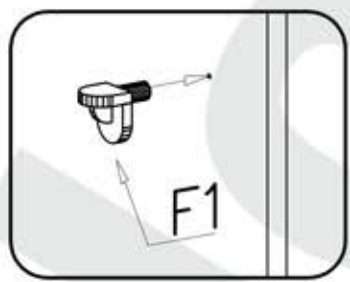

2

