

45 min.

- (D) Montageanleitung
- (FR) Notice de montage
- (NL) Handleiding voor de montage
- (CZ) Montážní návod
- (HU) Szerelési útmutató
- (TR) Montaj talimatı

- (GB) Assembly Instructions
- (IT) Istruzioni di montaggio
- (PL) Instrukcja montażu
- (SK) Návod na montáž
- (RO) Instrucțiuni de montaj
- (RU) Инструкции по монтажу



L

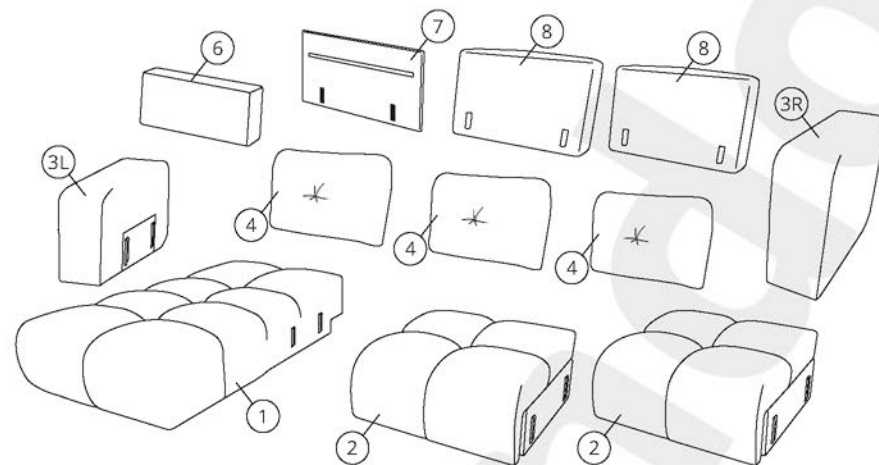

R

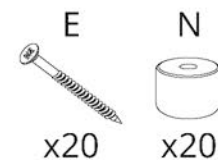
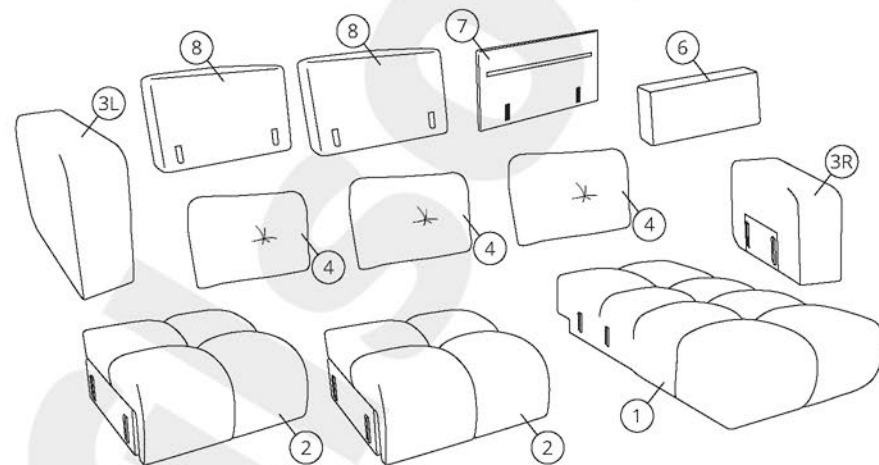

1L



2x

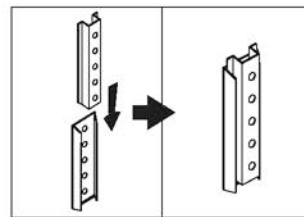
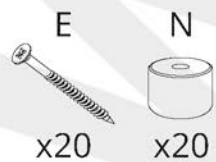
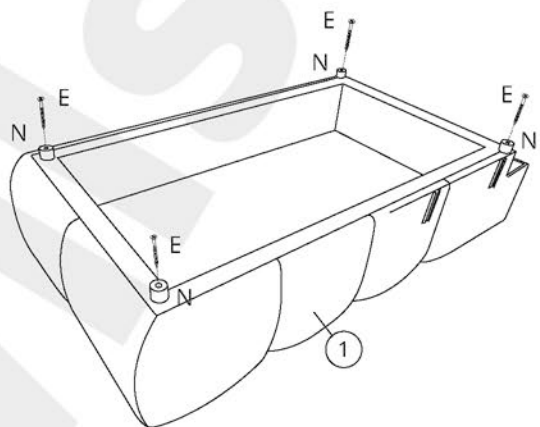
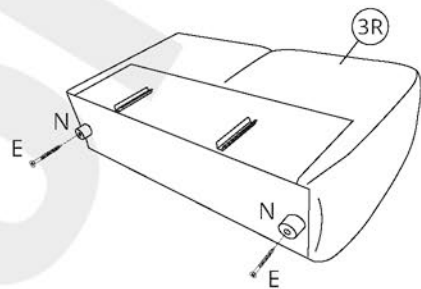
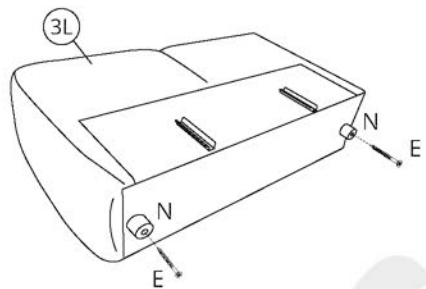
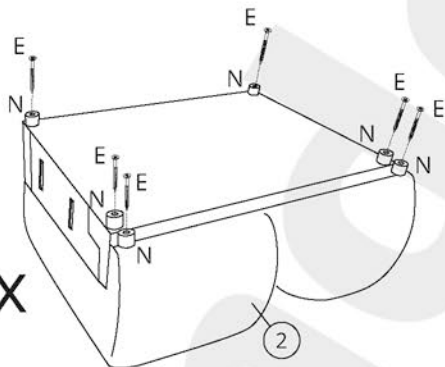

2L

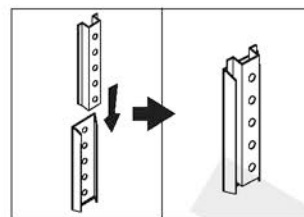
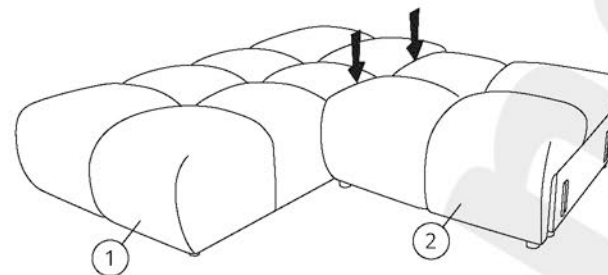

3L

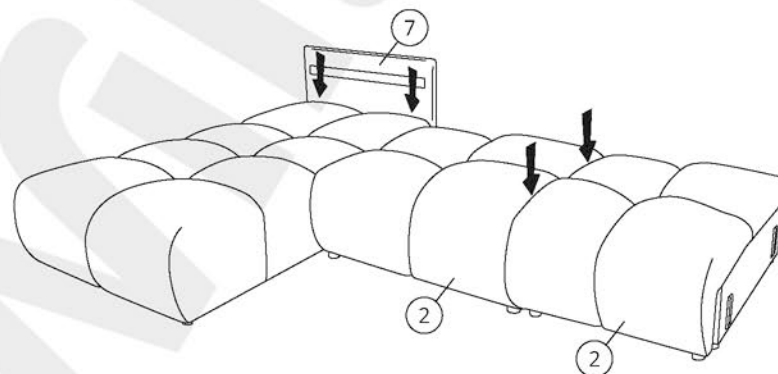

4L 

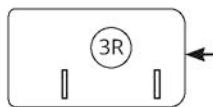
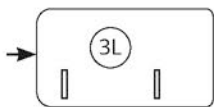
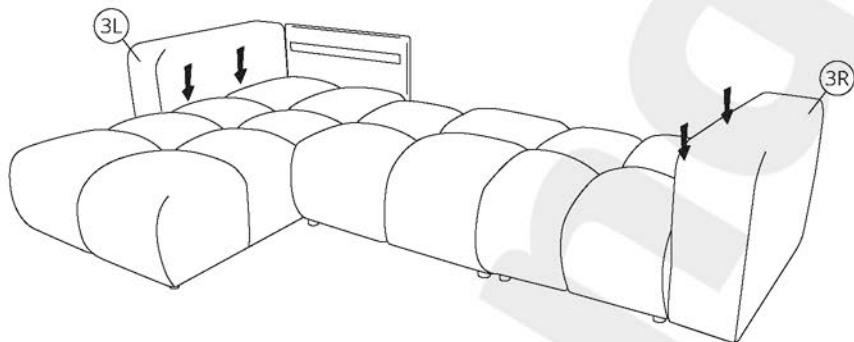
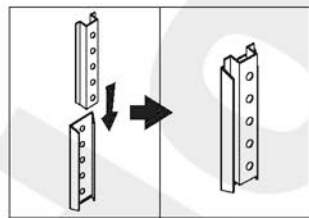

5L 

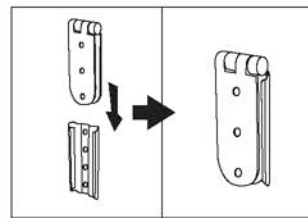
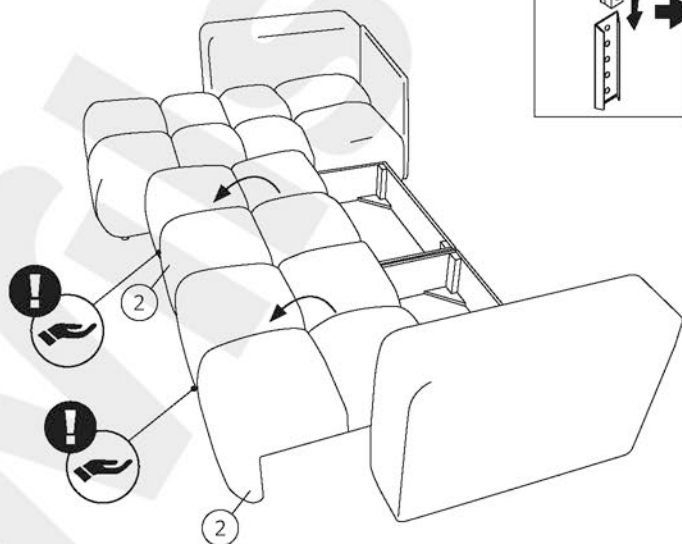
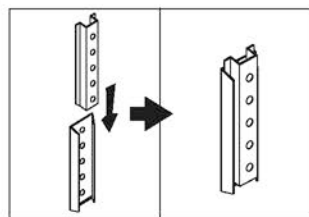

 6L

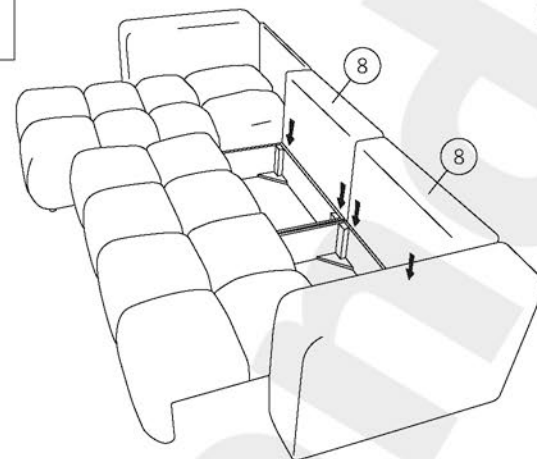

 7L

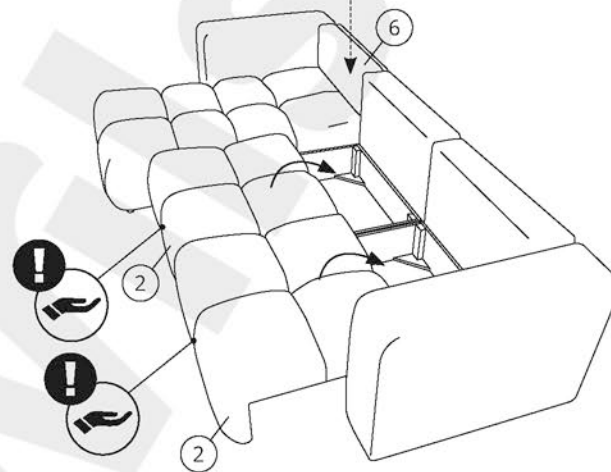

8L

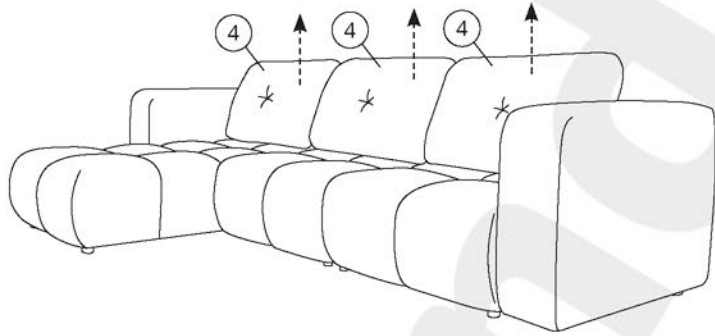
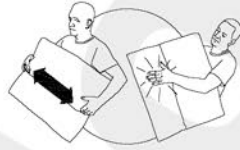
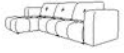

9L

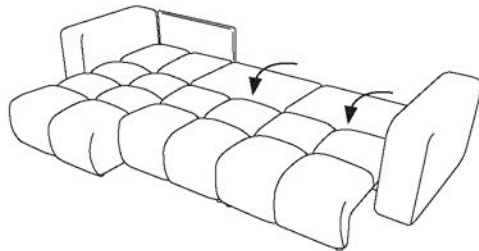
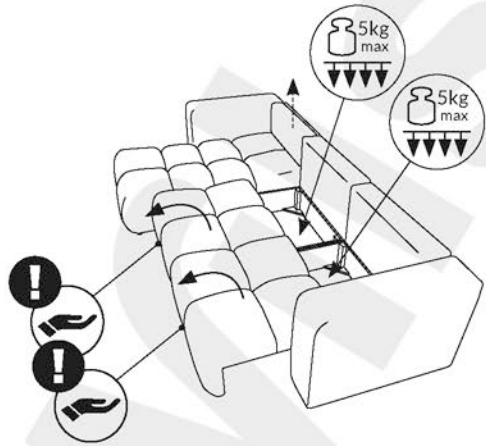
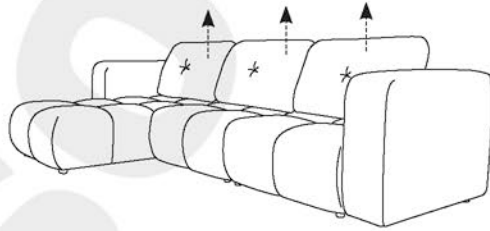
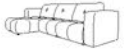



Wilsondo

1R 

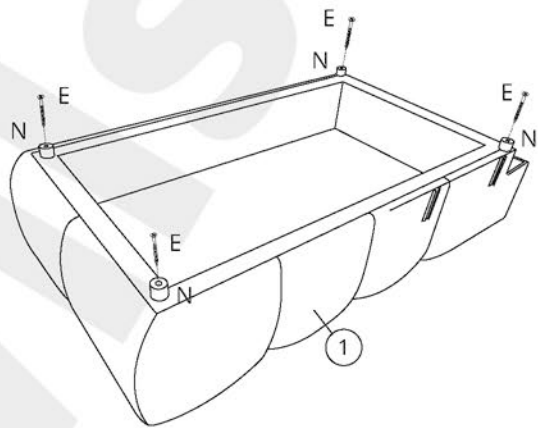
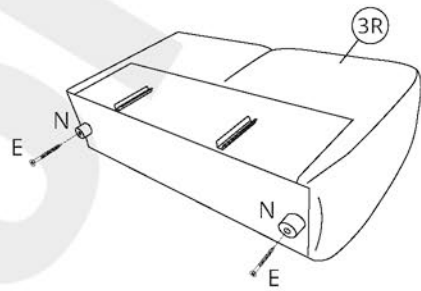
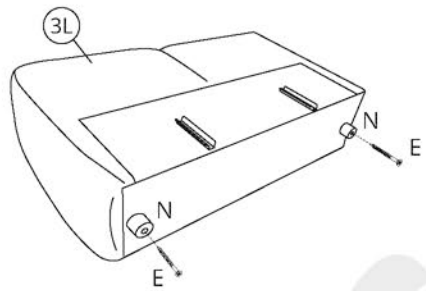
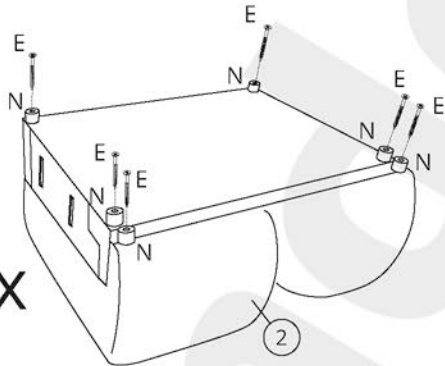

2x



E N
 x20  x20

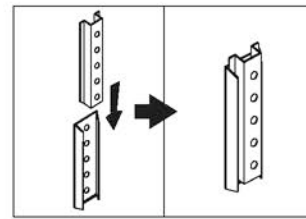

 2R

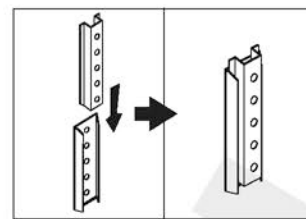
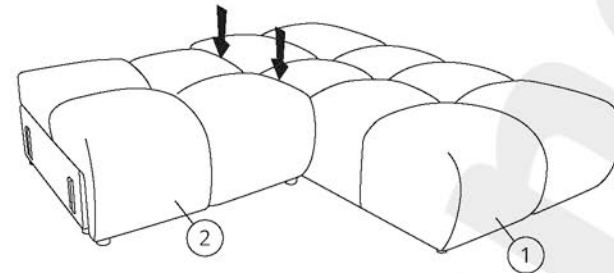

 3R

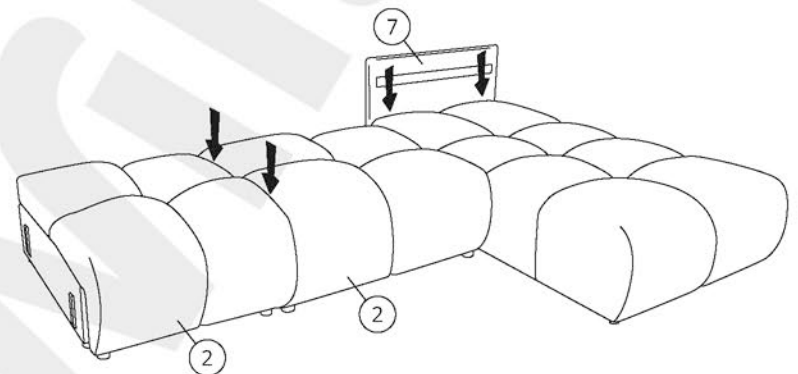

4R 

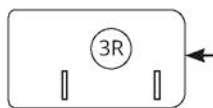
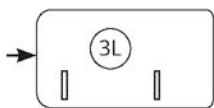
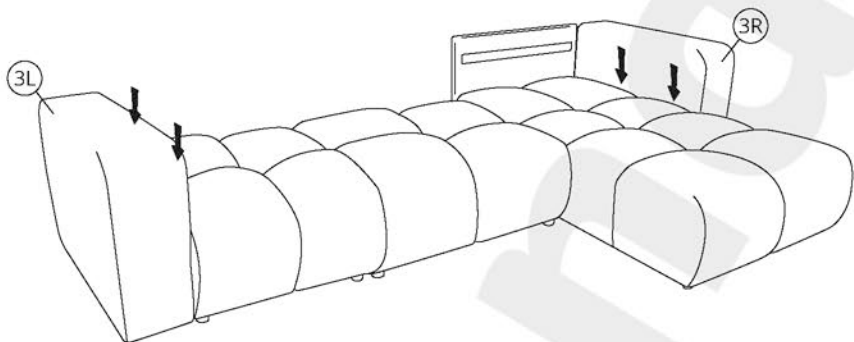
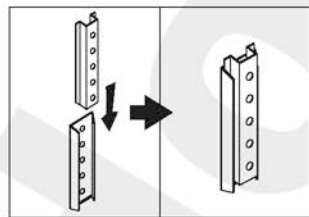

5R 

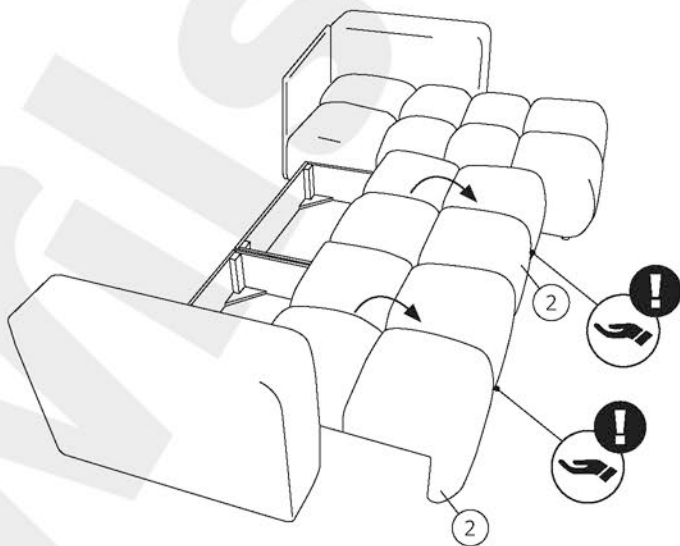

 6R

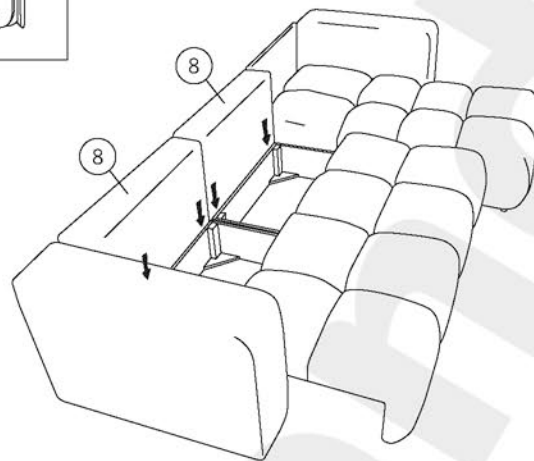
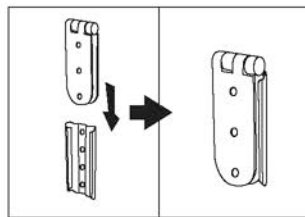

 7R

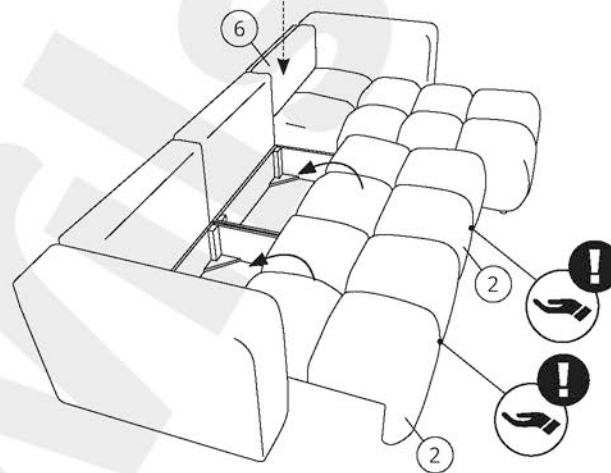

8R 

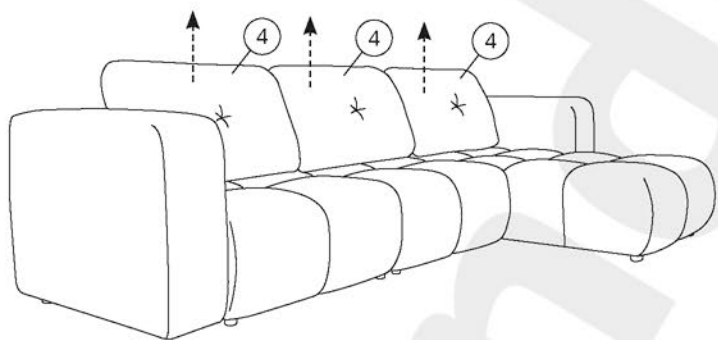

9R 

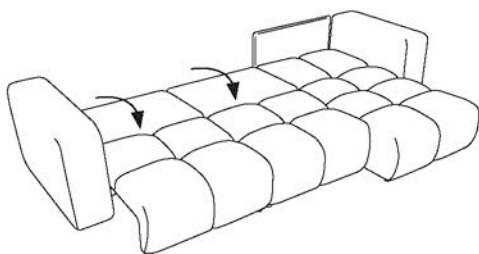
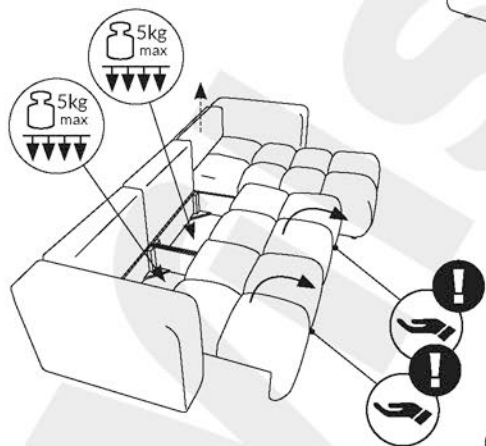
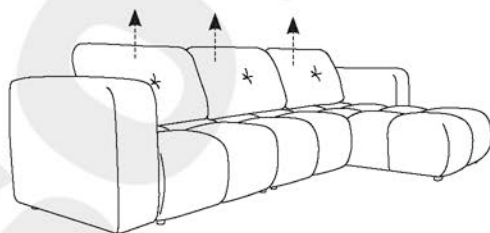

KARTA SERWISOWA / SERVICE FORM / SERVICEKARTE

L

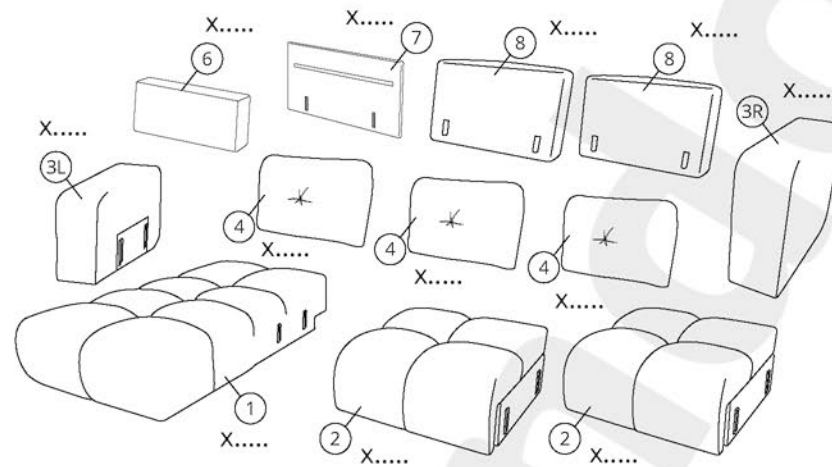

R

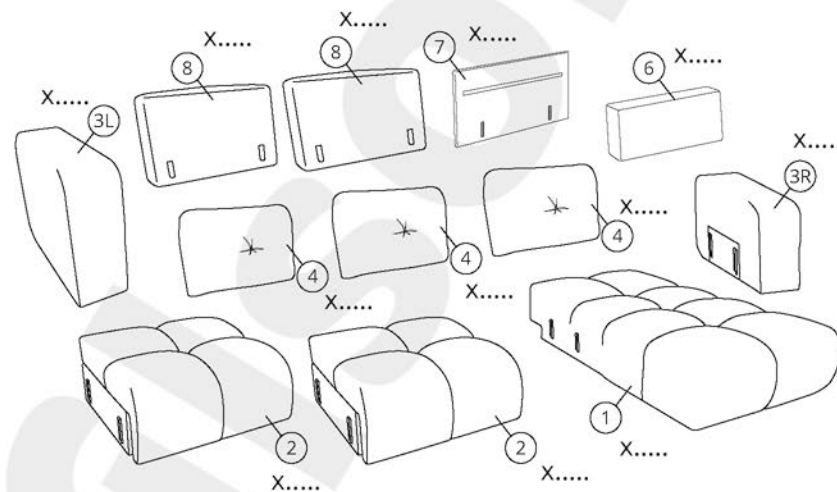

E N



X.... X....

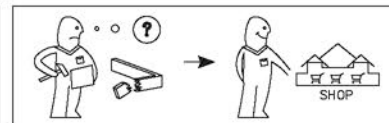
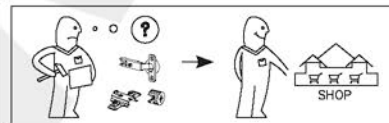
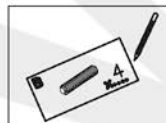



Uwaga - Upozornění - Achtung - Attention - Caution - Figyelem
Attenzione - Opgelet - Atentie - Upozornenie - Dikkat



PL

Meble zawierające płyty drewnopochodne mogą emitować substancje zanieczyszczające powietrze w pomieszczeniu. Dlatego zaleca się, aby po zamontowaniu mebli regularnie wietrzyć pomieszczenie przez co najmniej cztery tygodnie.

DE

Möbel mit Holzwerkstoffplatten können Schadstoffe an die Raumluft abgeben. Daher wird empfohlen, den Raum nach der Aufstellung der Möbel mindestens vier Wochen lang regelmäßig zu lüften.

NL

Meubels met houtvezelplaten kunnen vervuilende stoffen in de binnenlucht uitstoten. Het is daarom aan te raden om na plaatsing van de meubels de ruimte minimaal vier weken lang regelmatig te ventileren.

TR

Ahşap esaslı paneller içeren mobilyalar, iç mekan havasına kirletici maddeler salabilir. Bu nedenle, mobilyaların montajından sonra odanın en az dört hafta boyunca sık sık havalandırılması önerilir.

FR

Les meubles contenant des panneaux à base de bois peuvent émettre des substances polluantes dans l'air intérieur. Il est donc recommandé, après l'installation du meuble, d'aérer fréquemment la pièce pendant au moins quatre semaines.

CZ

Nábytek z dřevěných desek může do vnitřního ovzduší uvolňovat znečišťující látky. Proto se po instalaci nábytku doporučuje místnost často větrat po dobu alespoň čtyř týdnů.

HU

A faalapú paneleket tartalmazó bútorok szennyező anyagokat bocsáthatnak ki a beltéri levegőbe. Ezért ajánlott a bútorok beszerelése után legalább négy hétig gyakran szellőztetni a helyiséget.

GB

Furniture containing wood-based panels can emit polluting substances into the indoor air. It is therefore recommended, after installing the furniture, to ventilate the room frequently for at least four weeks.

RU

Мебель, изготовленная из древесных плит, может выделять загрязняющие вещества в воздух помещения. Поэтому после установки мебели рекомендуется часто проветривать помещение в течение как минимум четырёх недель.

IT

I mobili contenenti pannelli in legno possono rilasciare sostanze inquinanti nell'aria interna. Si raccomanda pertanto, dopo l'installazione dei mobili, di arieggiare frequentemente la stanza per almeno quattro settimane.

SK

Nábytok s drevenými panelmi môže do vnútorného ovzdušia uvoľňovať znečisťujúce látky. Preto sa odporúča po inštalácii nábytku miestnosť často vetrať aspoň štyri týždne.

RO

Mobilierul care conține panouri din lemn poate emite substanțe poluante în aerul interior. Prin urmare, se recomandă, după instalarea mobilierului, ventilarea frecventă a încăperii timp de cel puțin patru săptămâni.

ES

Los muebles con tableros derivados de la madera pueden emitir sustancias contaminantes al aire interior. Por lo tanto, se recomienda ventilar la habitación con frecuencia durante al menos cuatro semanas después de instalar los muebles.

PT

Móveis com painéis de madeira podem liberar substâncias poluentes no ar interno. Portanto, recomenda-se ventilar o ambiente frequentemente por pelo menos quatro semanas após a instalação.

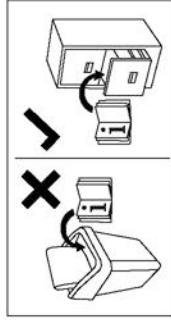



Uwaga - Upozorniní - Achtung - Attention - Caition - Figyelem
 Attenzione - Opgelet - Atenție - Upozornenie - Dikkat

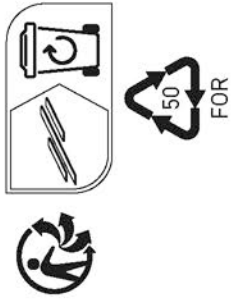
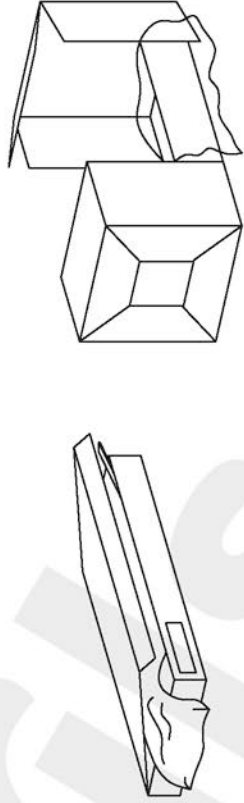

50 FOR



20 C PAPER



06 PS



03 PVC

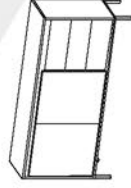
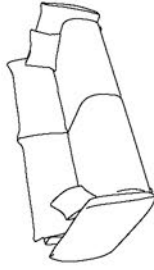

50 FOR



61 TEX



62 TEX



01 PET



70 GLS

78 GLS

79 GLS



40 FE

41 ALU



50 FOR

40 FE

03 PVC

03 PCW



96 GLS + ALU

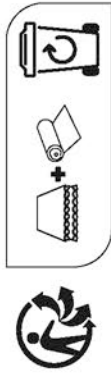

05 PP

05 PEHD



19 Alkaline

11 NiMH

10 NiCd

08 Lead



12 Li

40 FE

03 PVC

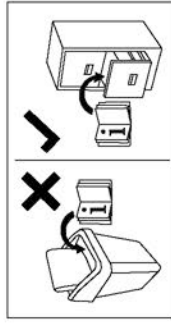



Uwaga - Upozorniní - Achtung - Attention - Caition - Figyelem
Attenzione - Opgelet - Atenție - Upozornenie - Dikkat

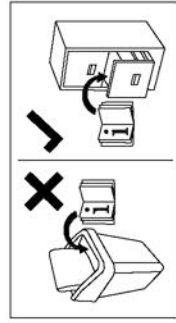
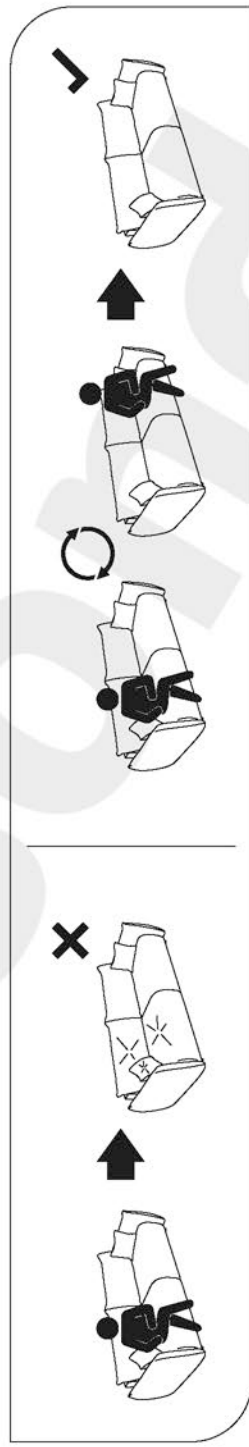
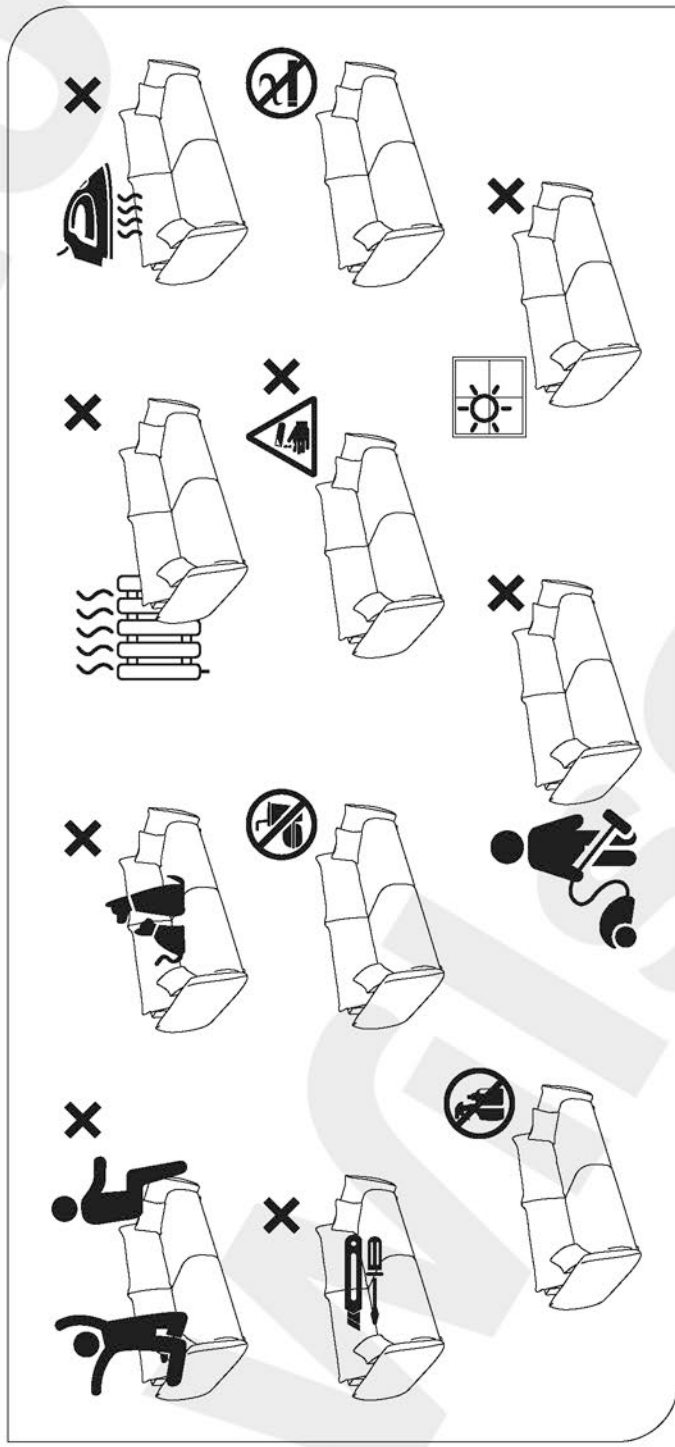
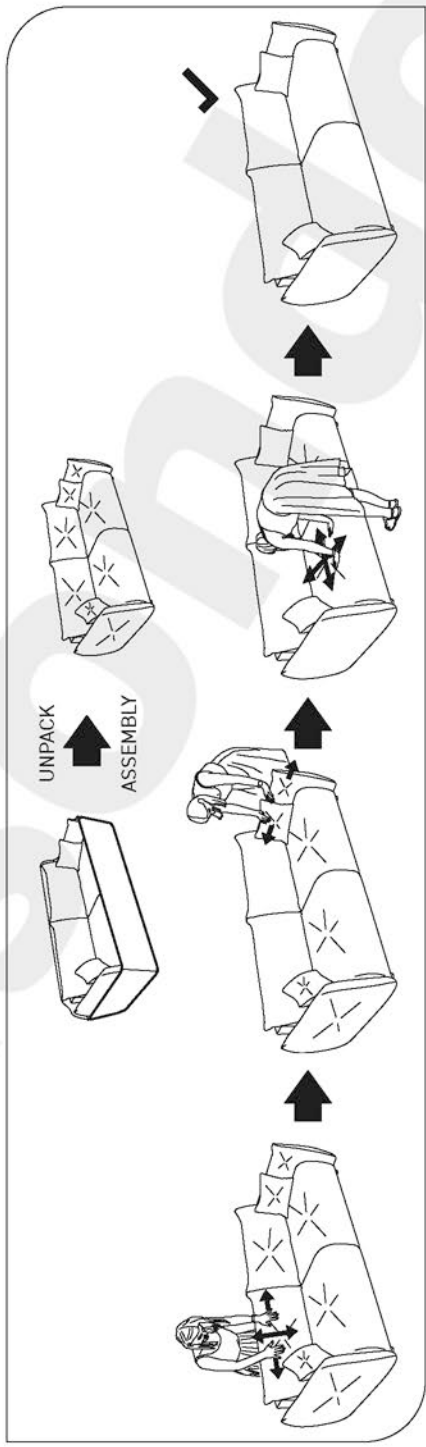
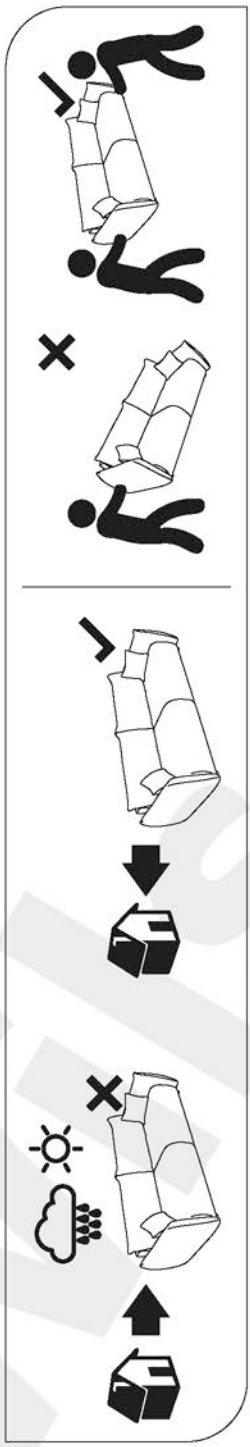



Uwaga - Upozorniní - Achtung - Attention - Caition - Figyelem
Attenzione - Opgelet - Atenție - Upozornenie - Dikkat

