

MORE 01

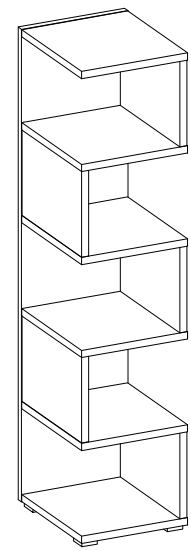

$\dagger 10 \times 50 \text{mm}$ O7	$\dagger 5.0 \times 70 \text{mm}$ P29	$\dagger 20$ E11							
1	1	1							
$\dagger 8 \times 30 \text{mm}$ A	$6.4 \times 50 \text{mm}$ B	$\dagger 5 / \dagger 8 \text{mm}$ C6	L=20mm D2		$60 \times 40 \times 20$ F1	$\dagger 4.0 \times 25 \text{mm}$ P14			
20	12	10	10	10	4	8	1		

ISM-RMO-001

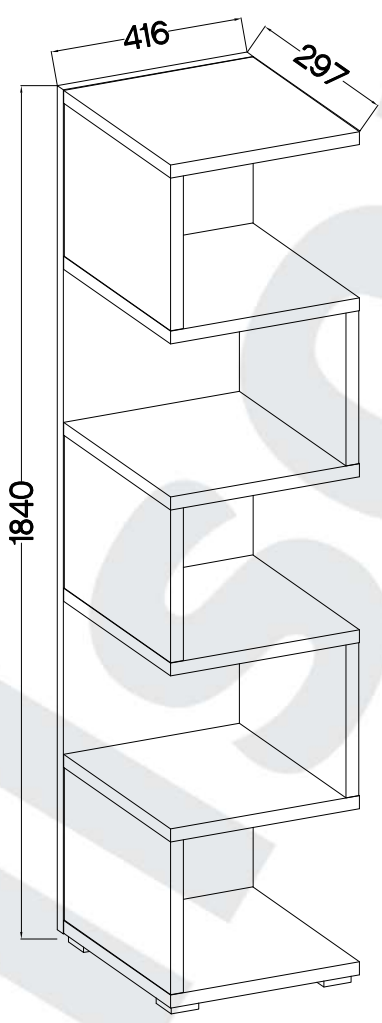
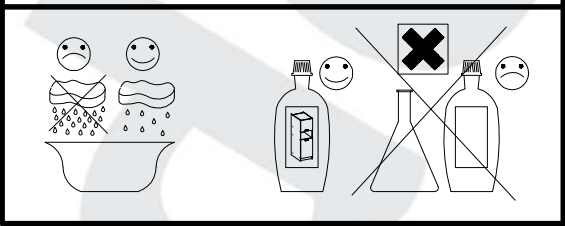
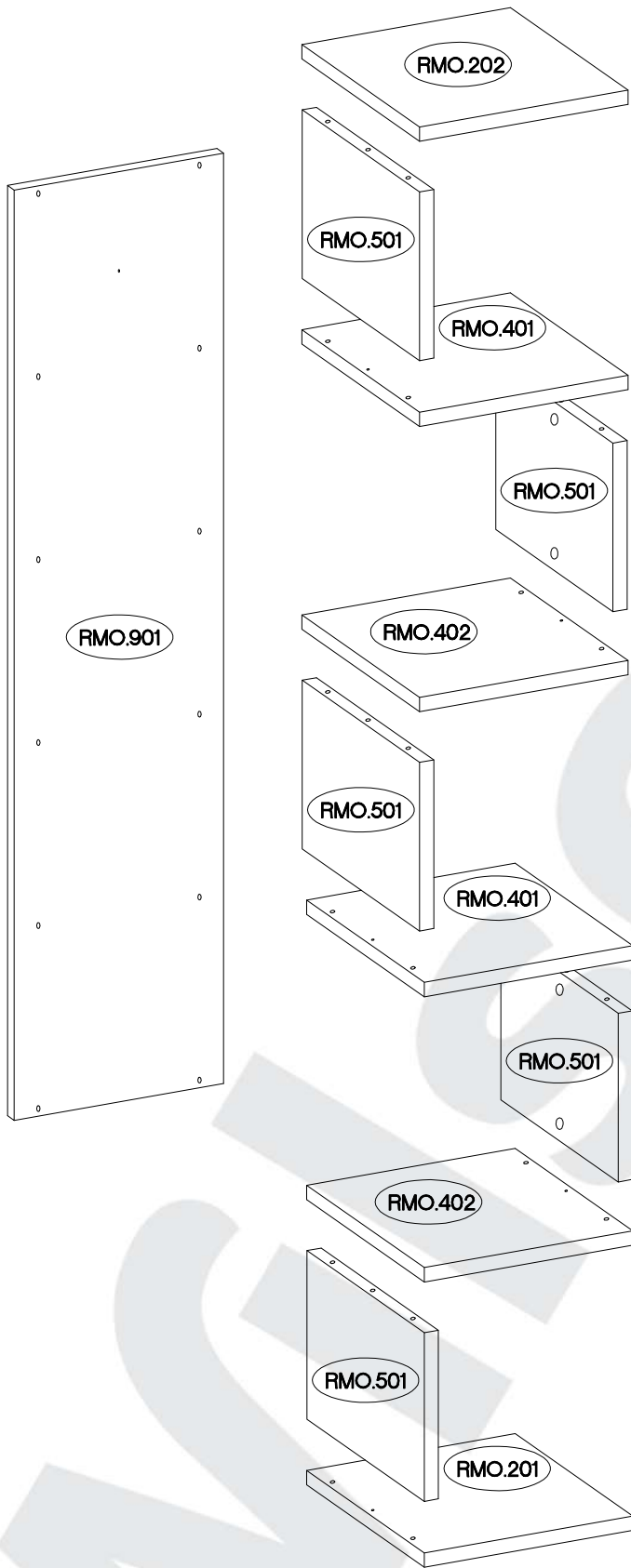

- RMO.201
- RMO.202
- RMO.401
- RMO.402

Colli	Ersatzteil Nummer	Dimension
Colli 1/1	RMO.201	414x281x28
	RMO.202	414x281x28
	RMO.401 x 2	414x281x28
	RMO.402 x 2	414x281x28
	RMO.501 x 5	330x280x28
	RMO.901	1820x416x16

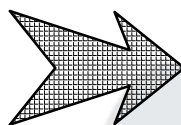
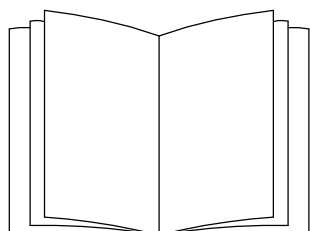
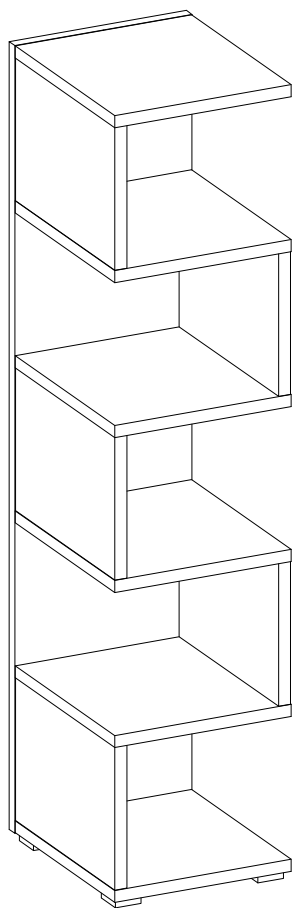

1

—

17

35

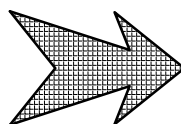
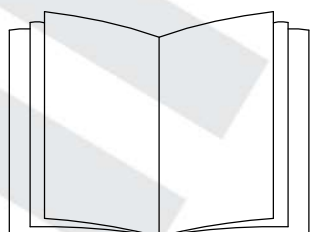
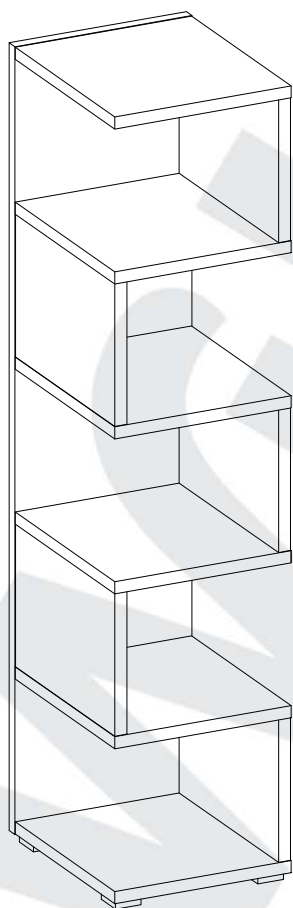

18

—

34

35

1

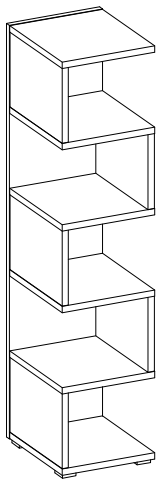

$\varnothing 8 \times 30 \text{mm}$ A 20	$\varnothing 15/18 \text{mm}$ C6 10	$L=20 \text{mm}$ D2 10	$60 \times 40 \times 20$ F1 4	$\varnothing 4.0 \times 25 \text{mm}$ P14 8
---	--	---	--	--

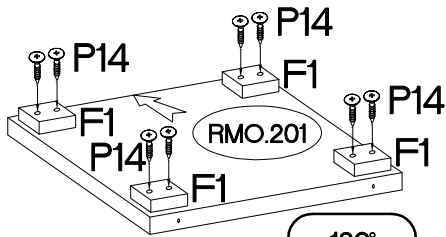
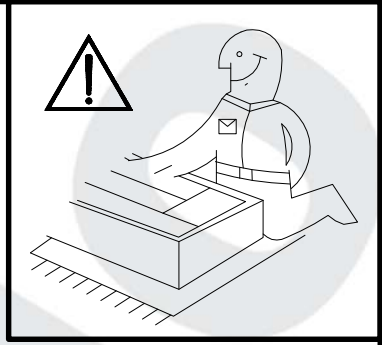

x1

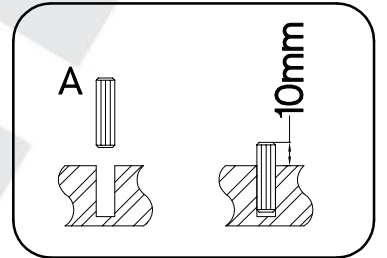
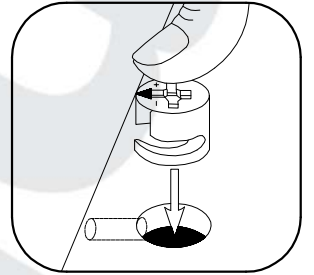
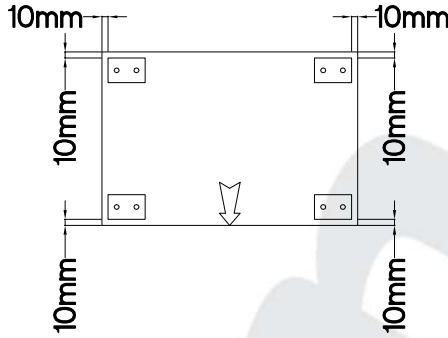
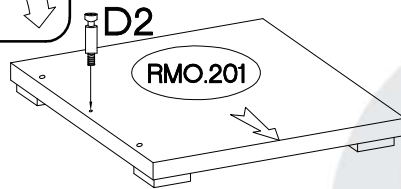
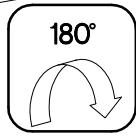

x1

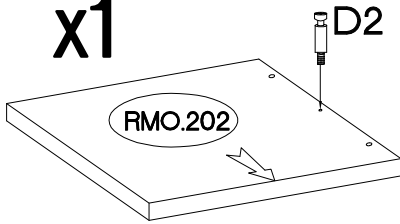

x2

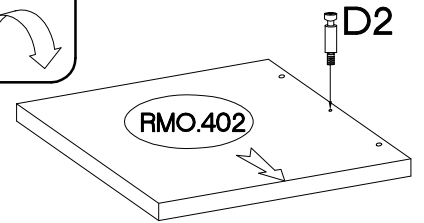
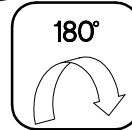

x2

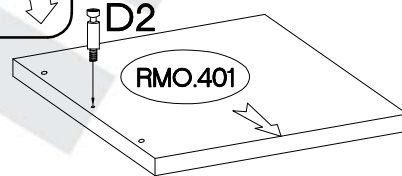
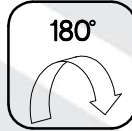

x5

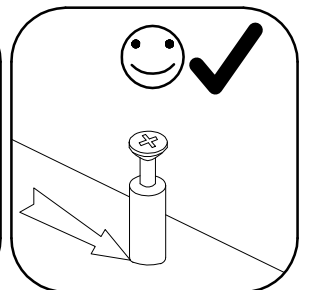
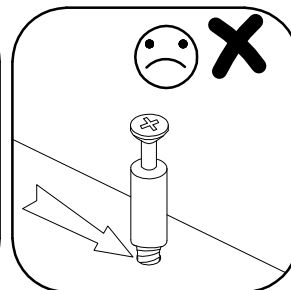
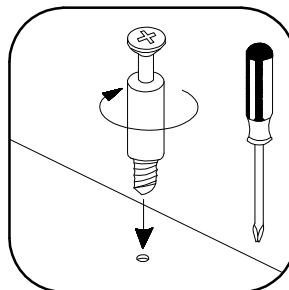
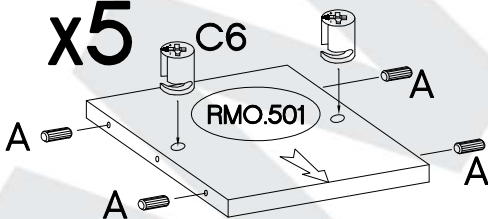

2

6,4 x 50mm

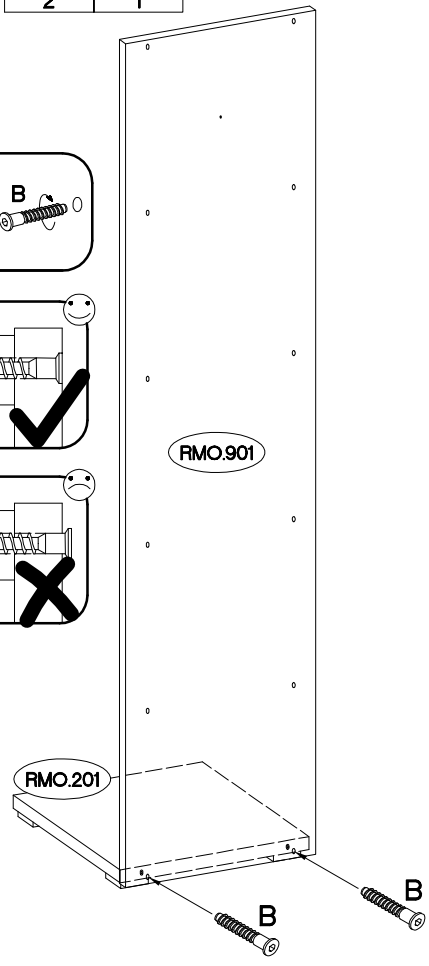
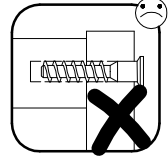
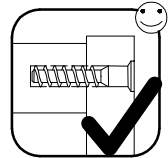
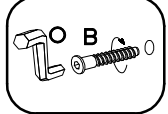
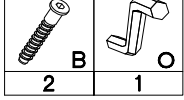

3

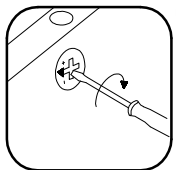
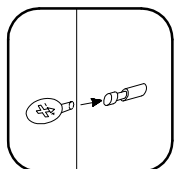
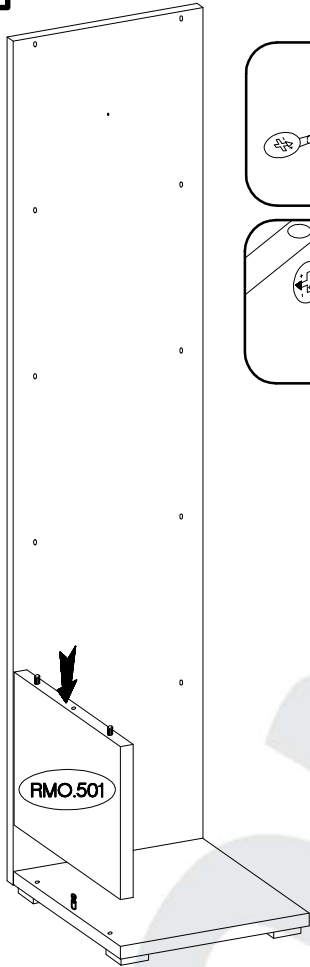

4

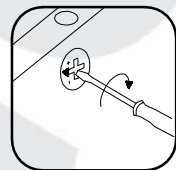
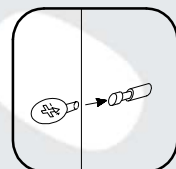
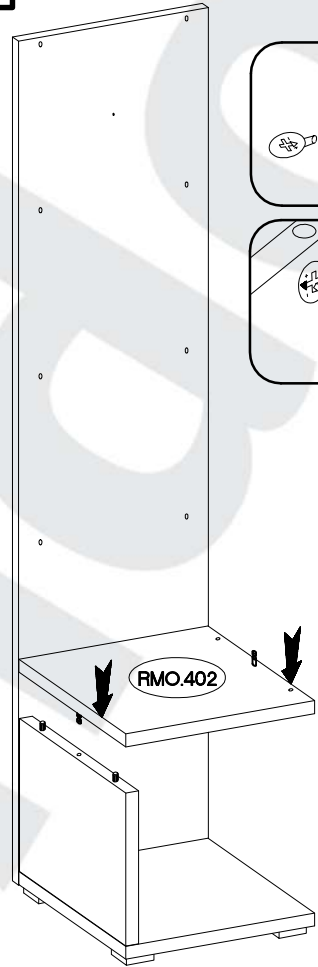

5

6,4 x 50mm

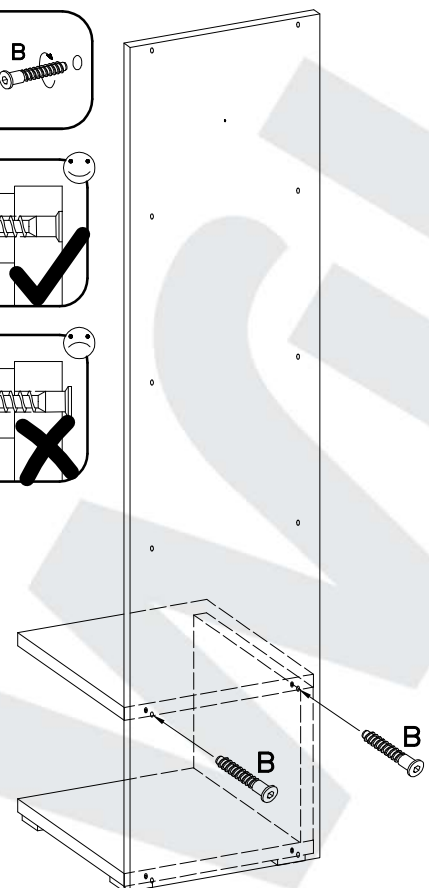
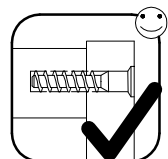
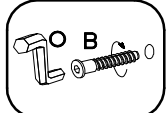
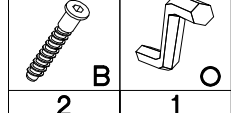

6

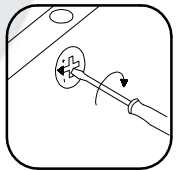
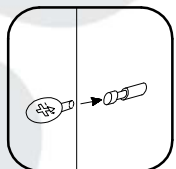
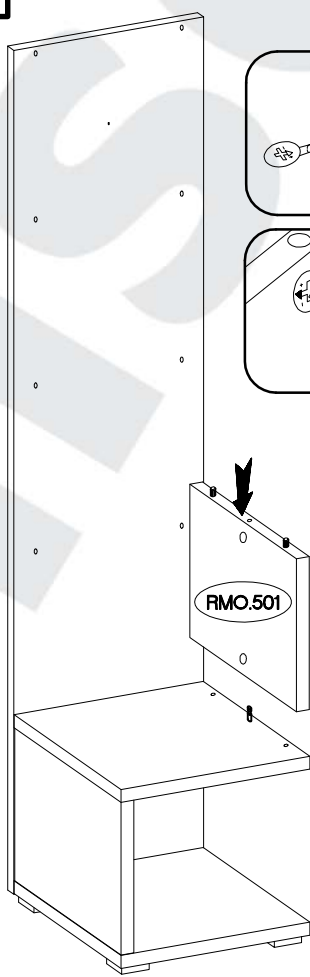

7

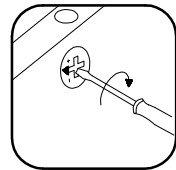
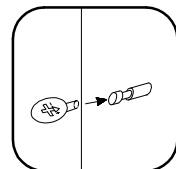
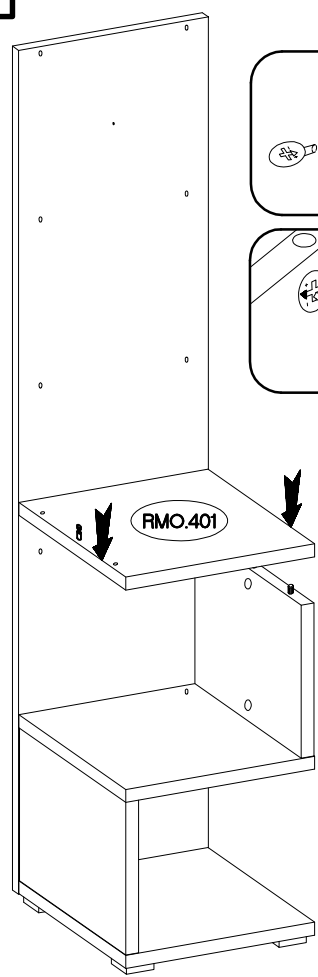

8

6,4 x 50mm



B



O

2

1

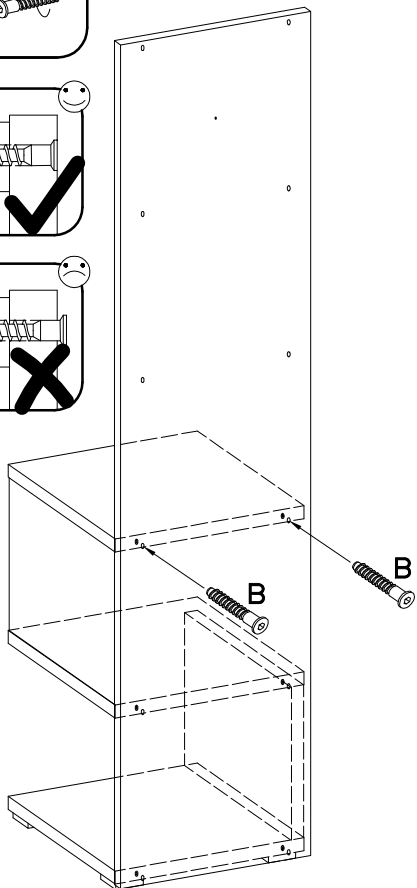
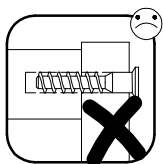
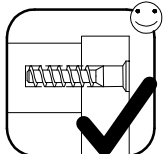
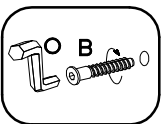

9

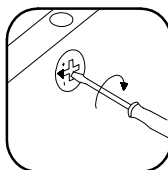
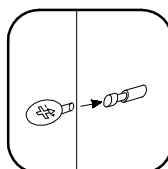
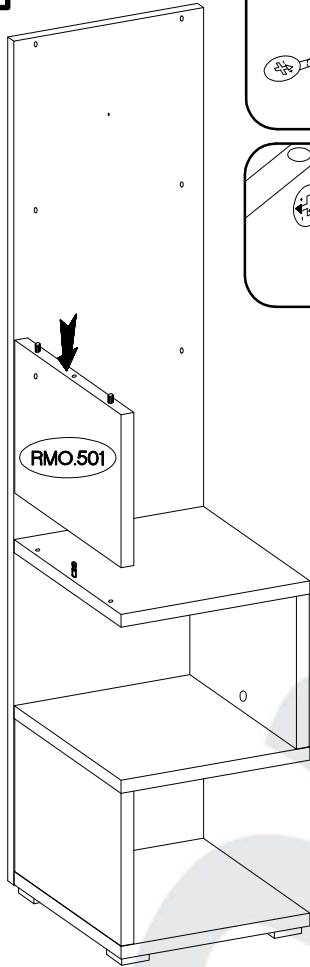

10

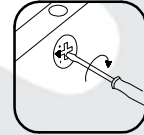
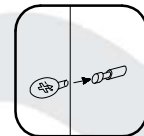
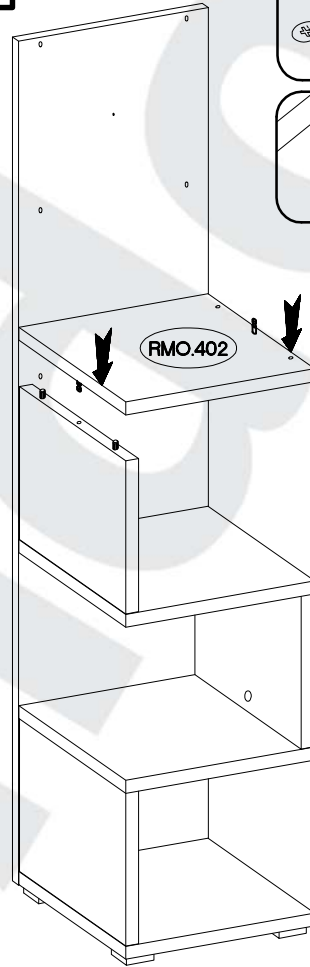

11

6,4 x 50mm



B



O

2

1

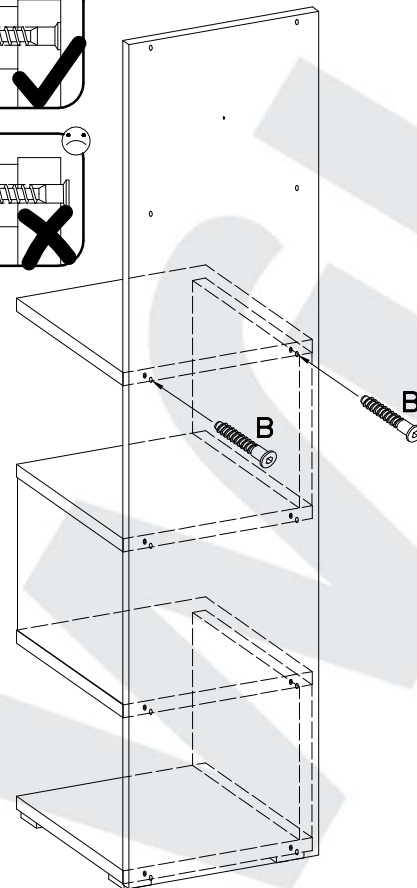
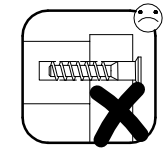
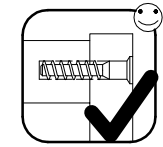

12

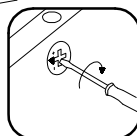
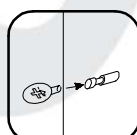
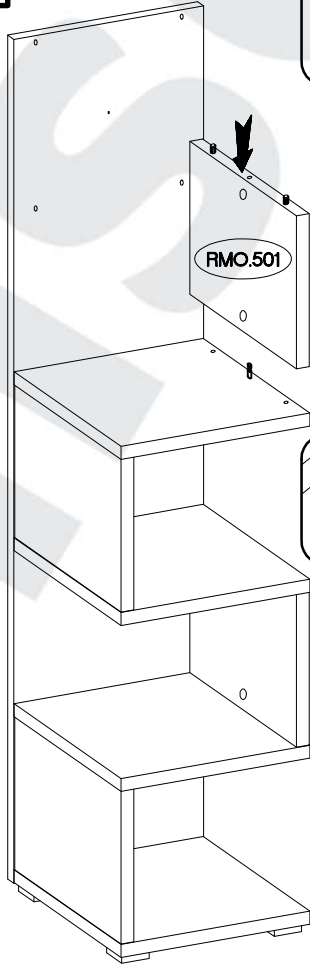

13

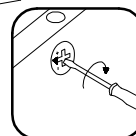
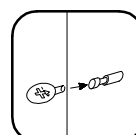
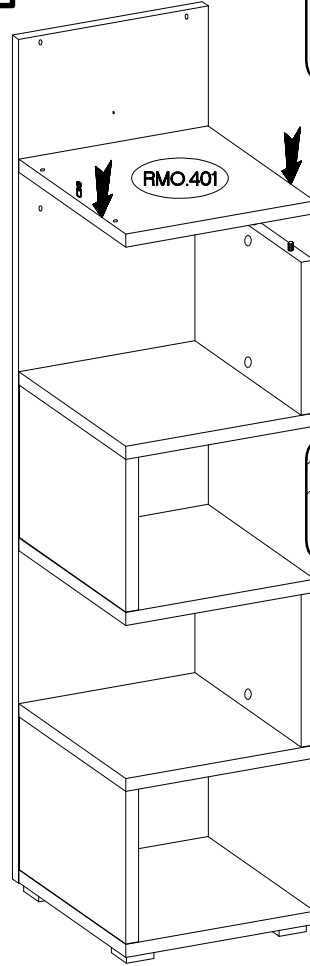

14

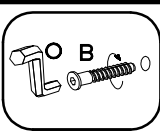

6,4 x 50mm



2

1

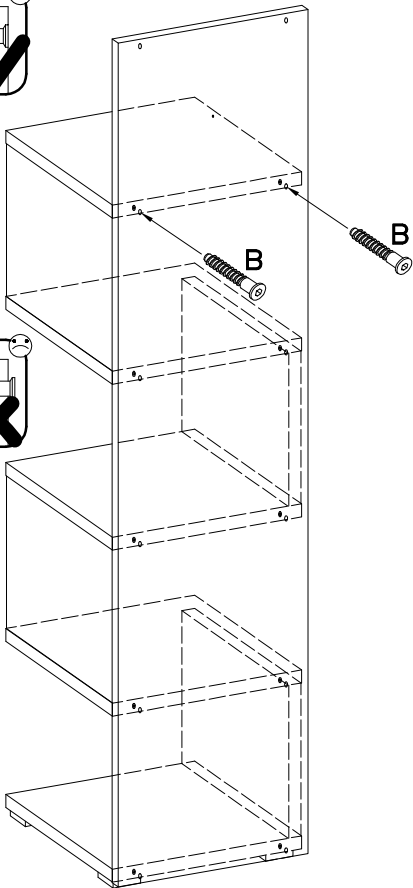

15

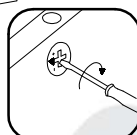
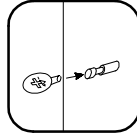
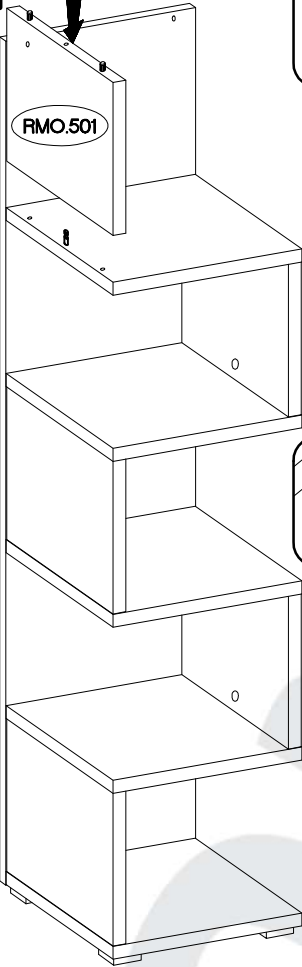

16

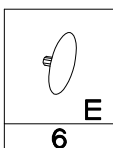
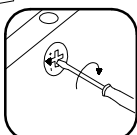
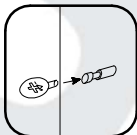
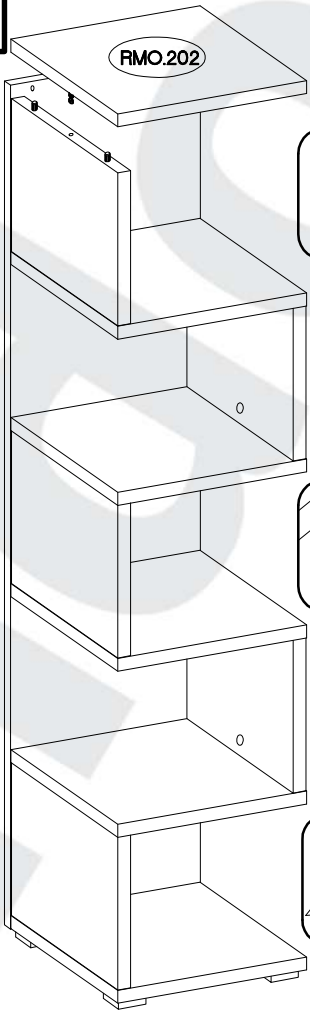

6

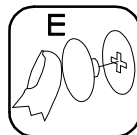

17

6,4 x 50mm



2

1

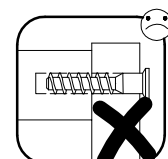
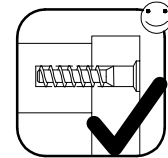
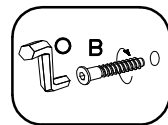
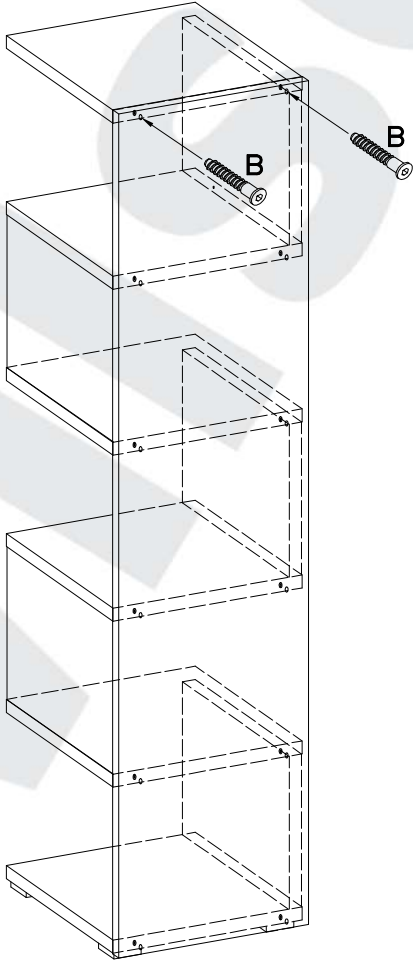

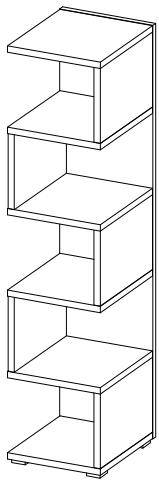

†8x30mm	†15/18mm	L=20mm	60x40x20	†4.0x25mm
A	C6	D2	F1	P14
20	10	10	4	8

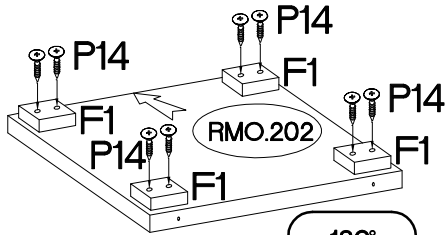
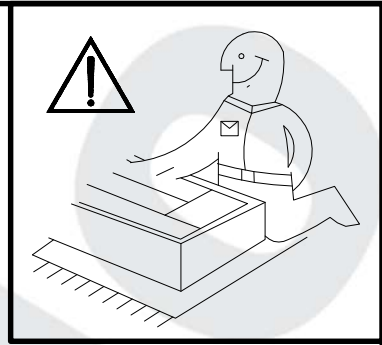

x1

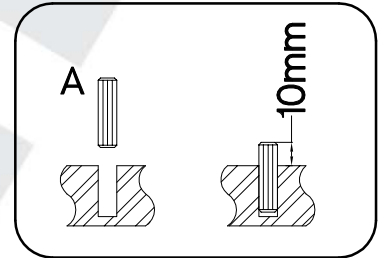
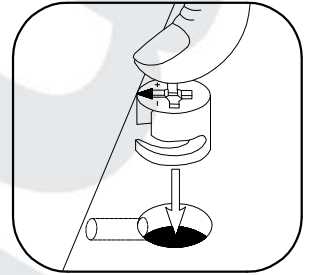
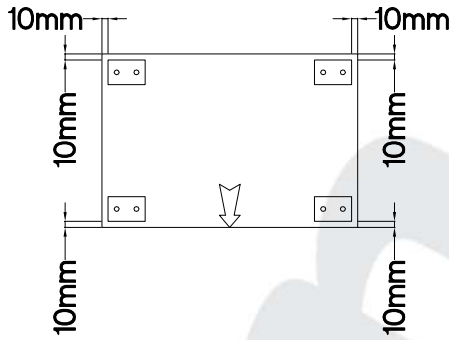
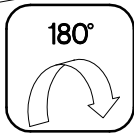

x1

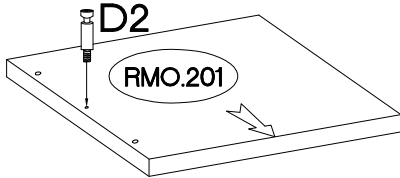

x2

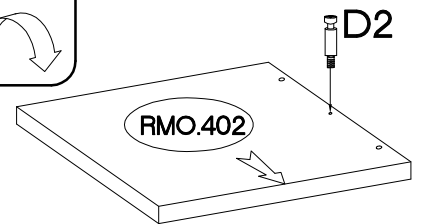
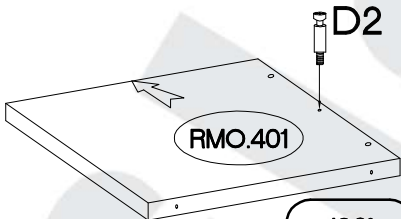
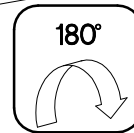

x2

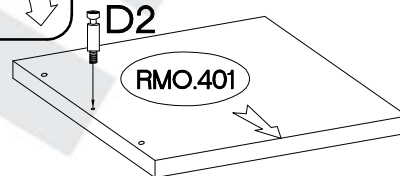
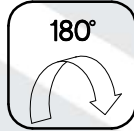

x5

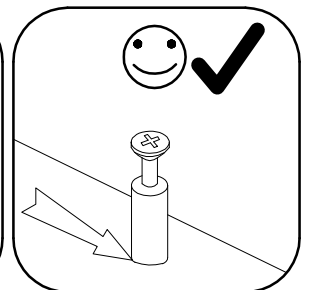
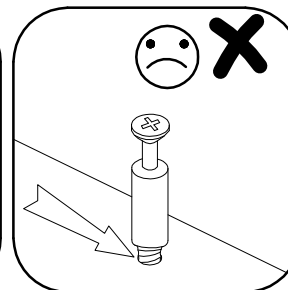
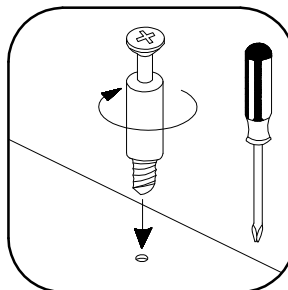
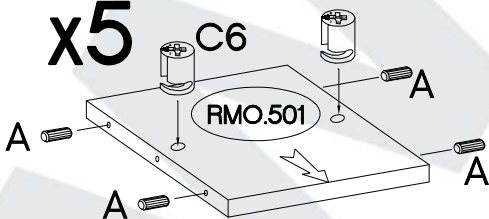

19

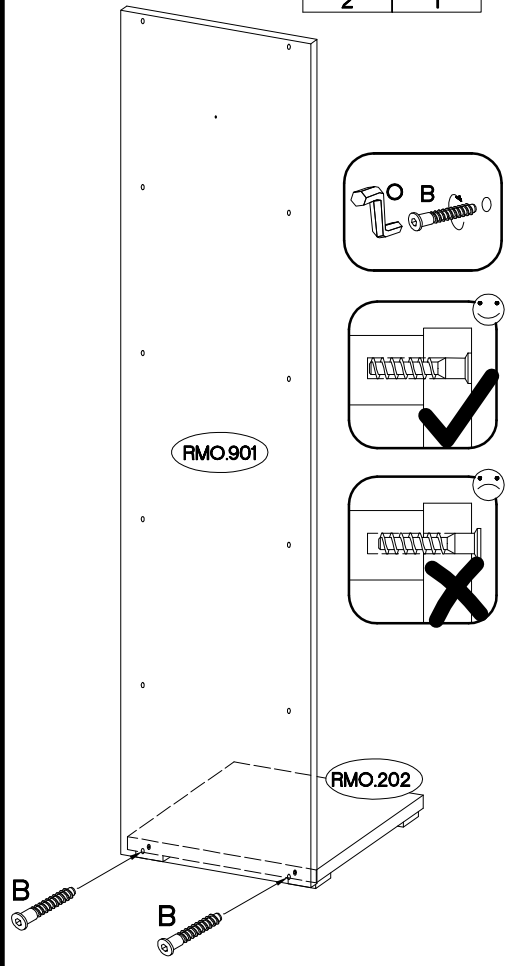
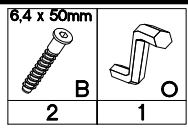

20

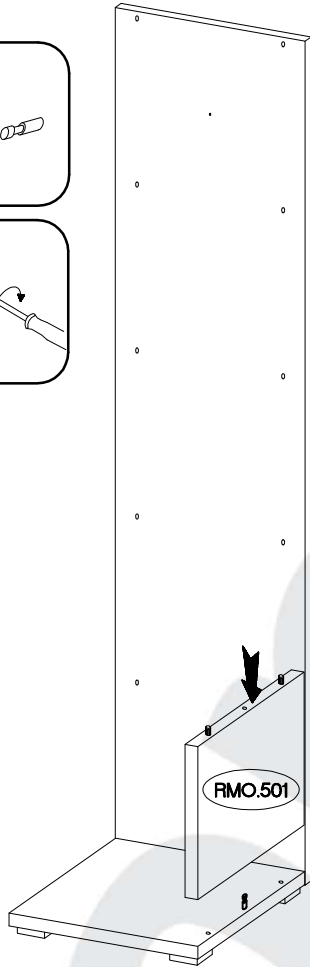
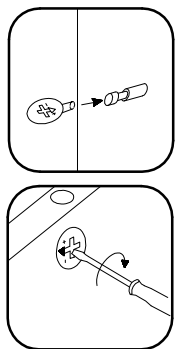

21

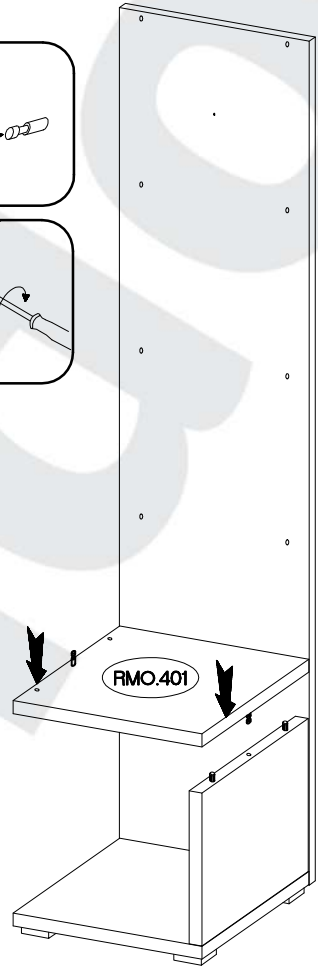
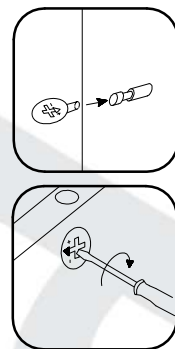

22

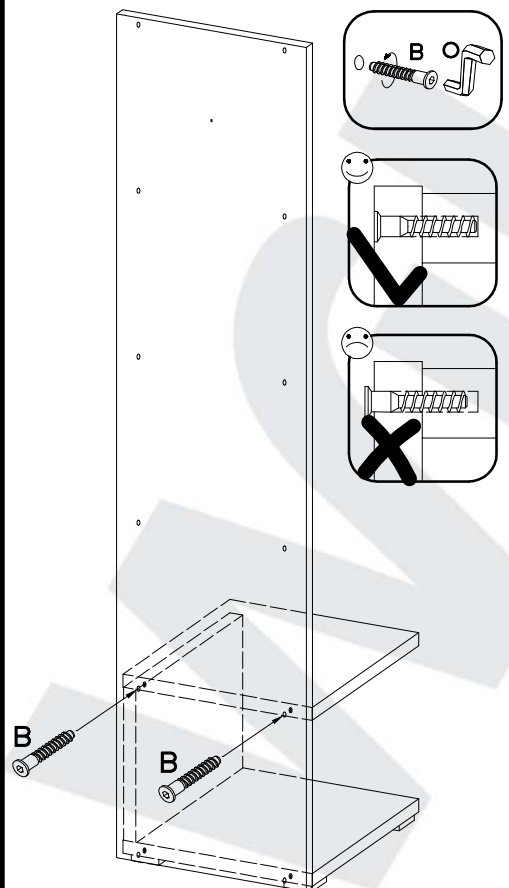
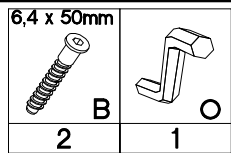

23

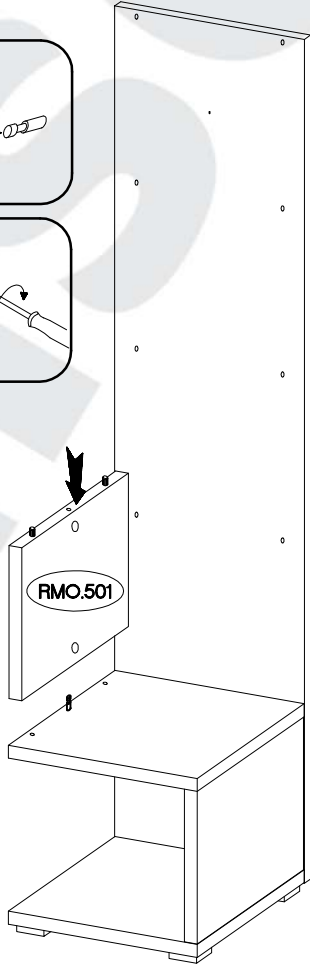
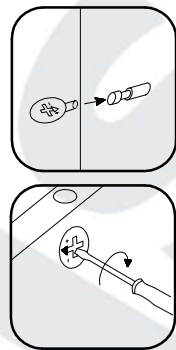

24

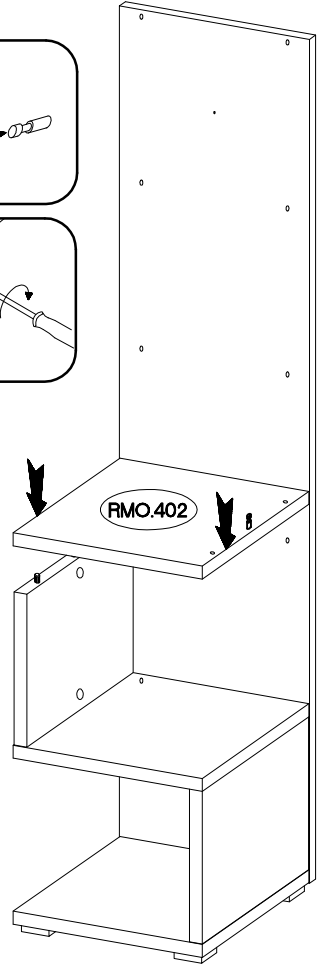
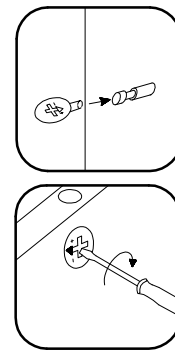

25

6,4 x 50mm



B



O

1

2

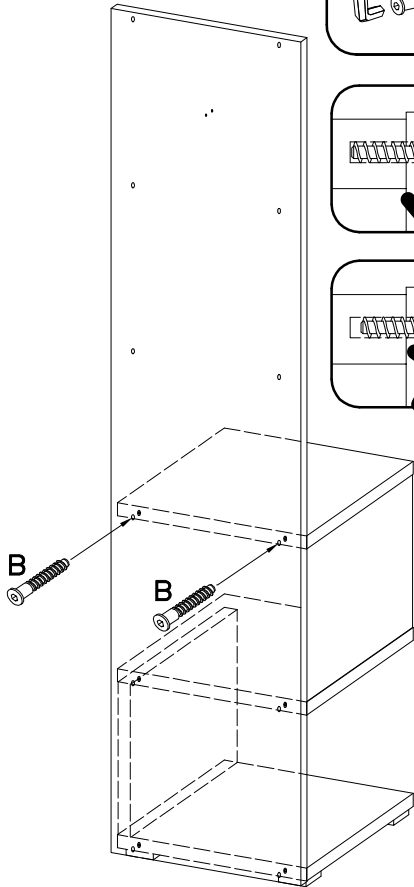
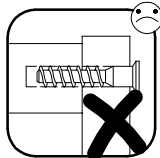
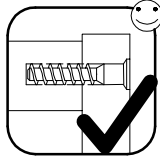
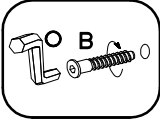

26

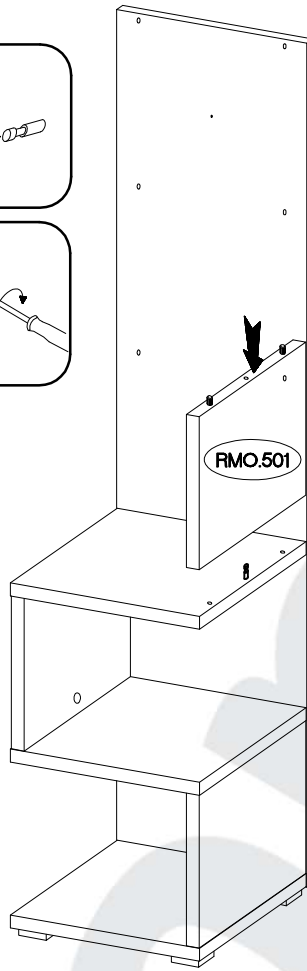
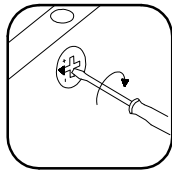
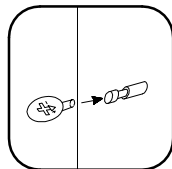

27

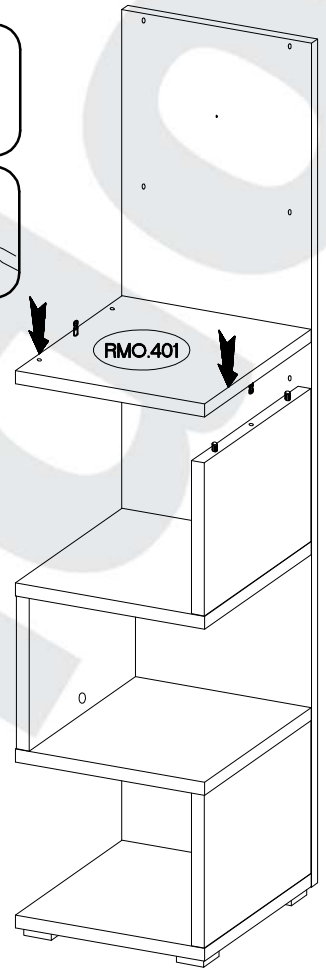
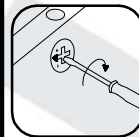
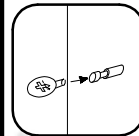

28

6,4 x 50mm



B



O

1

2

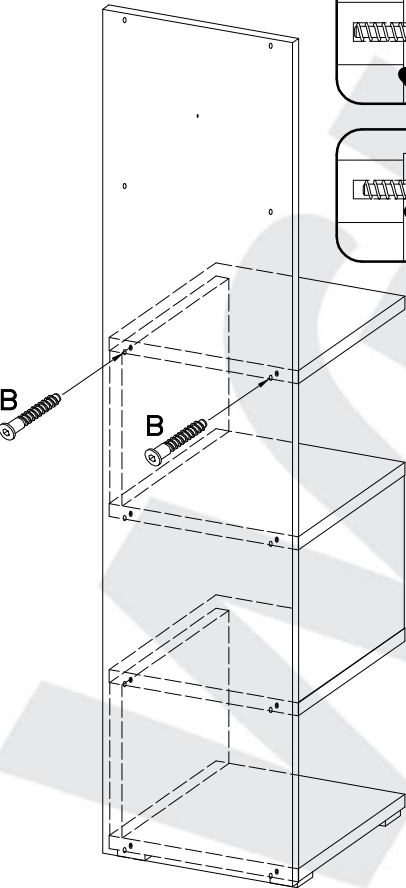
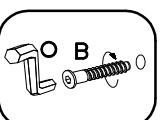

29

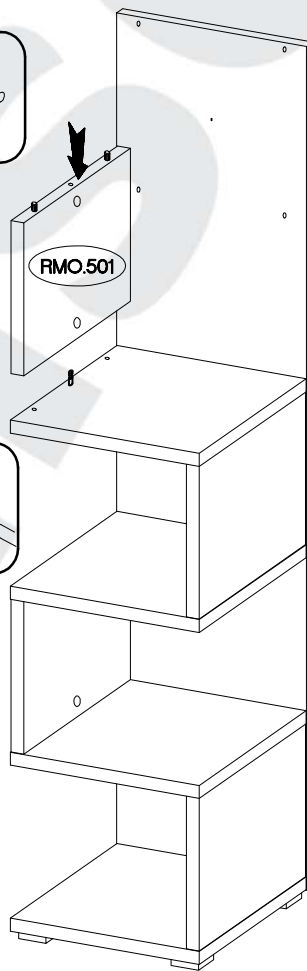
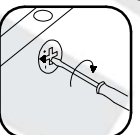
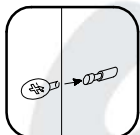

30

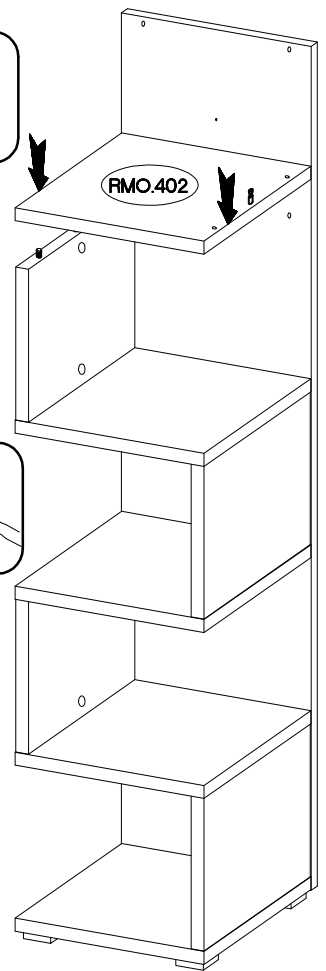
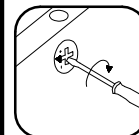
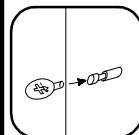

31

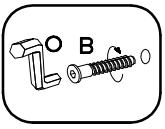

6,4 x 50mm



2

1

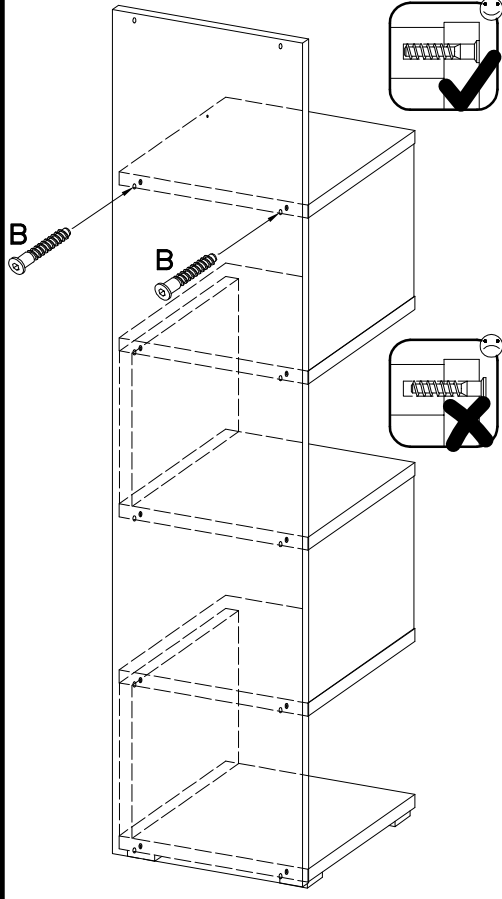

32

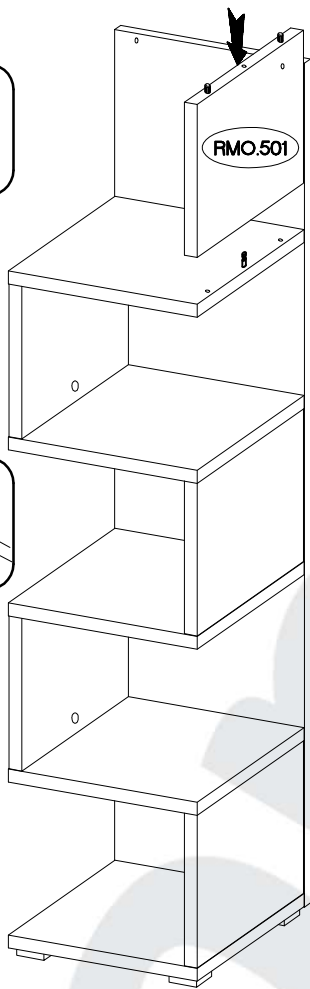
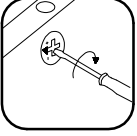
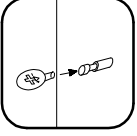

33

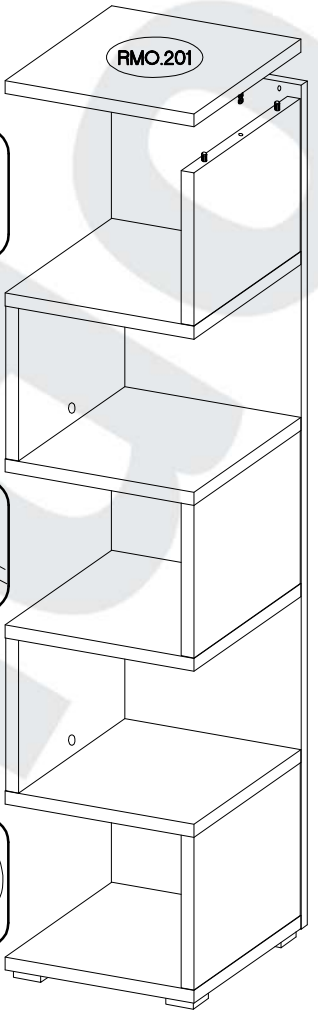
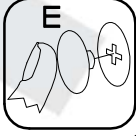
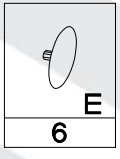
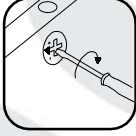
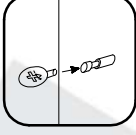

34

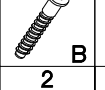

6,4 x 50mm

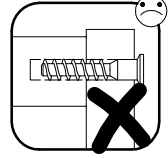
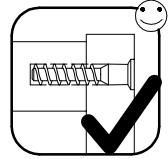
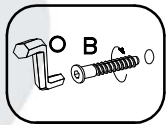
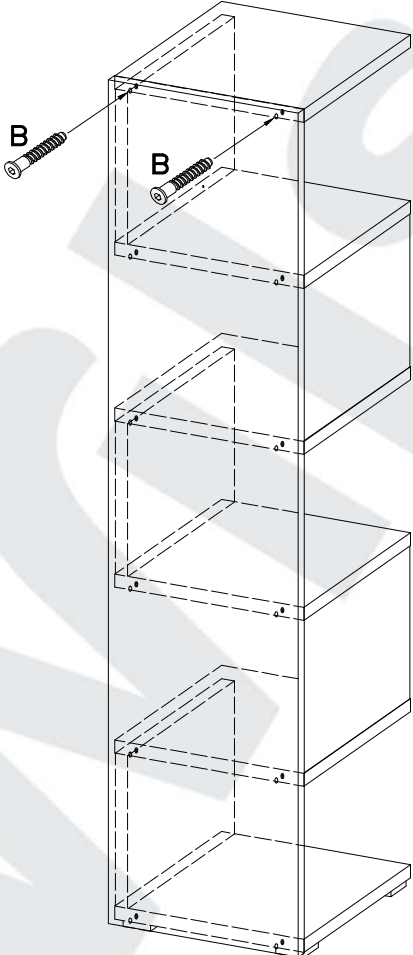

2

1



 #10x50mm O7 1	 #5.0x70mm P29 1	 #20 E11 1
--	--	--

