

ELENA NA 2D NAR

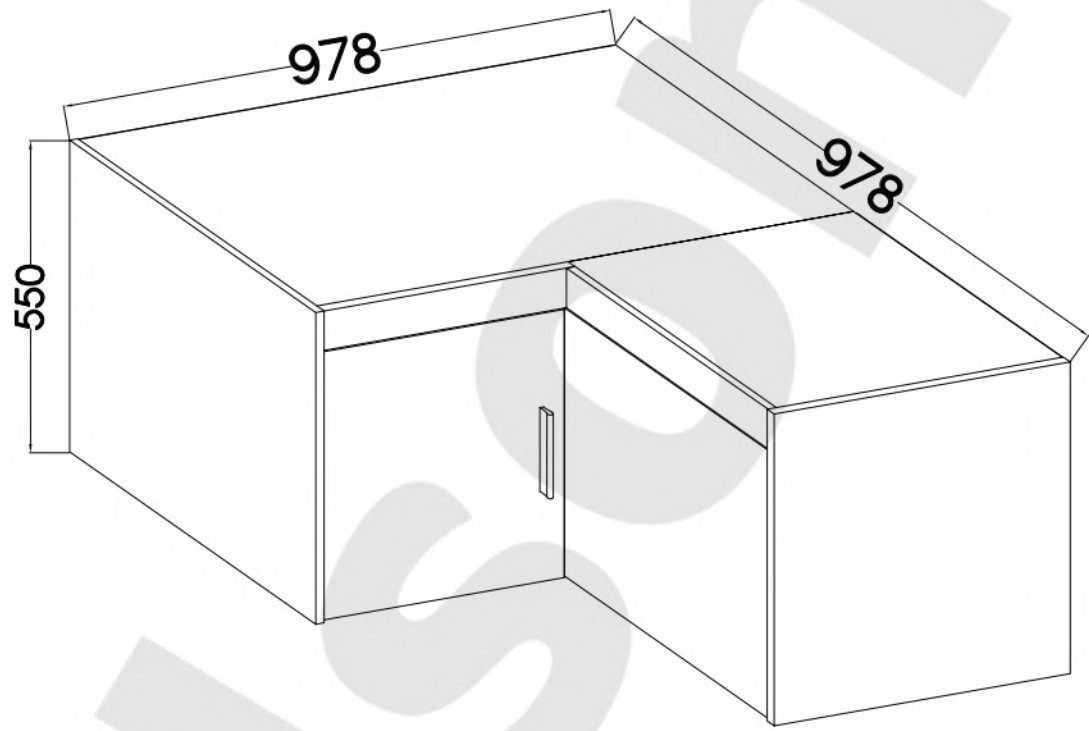

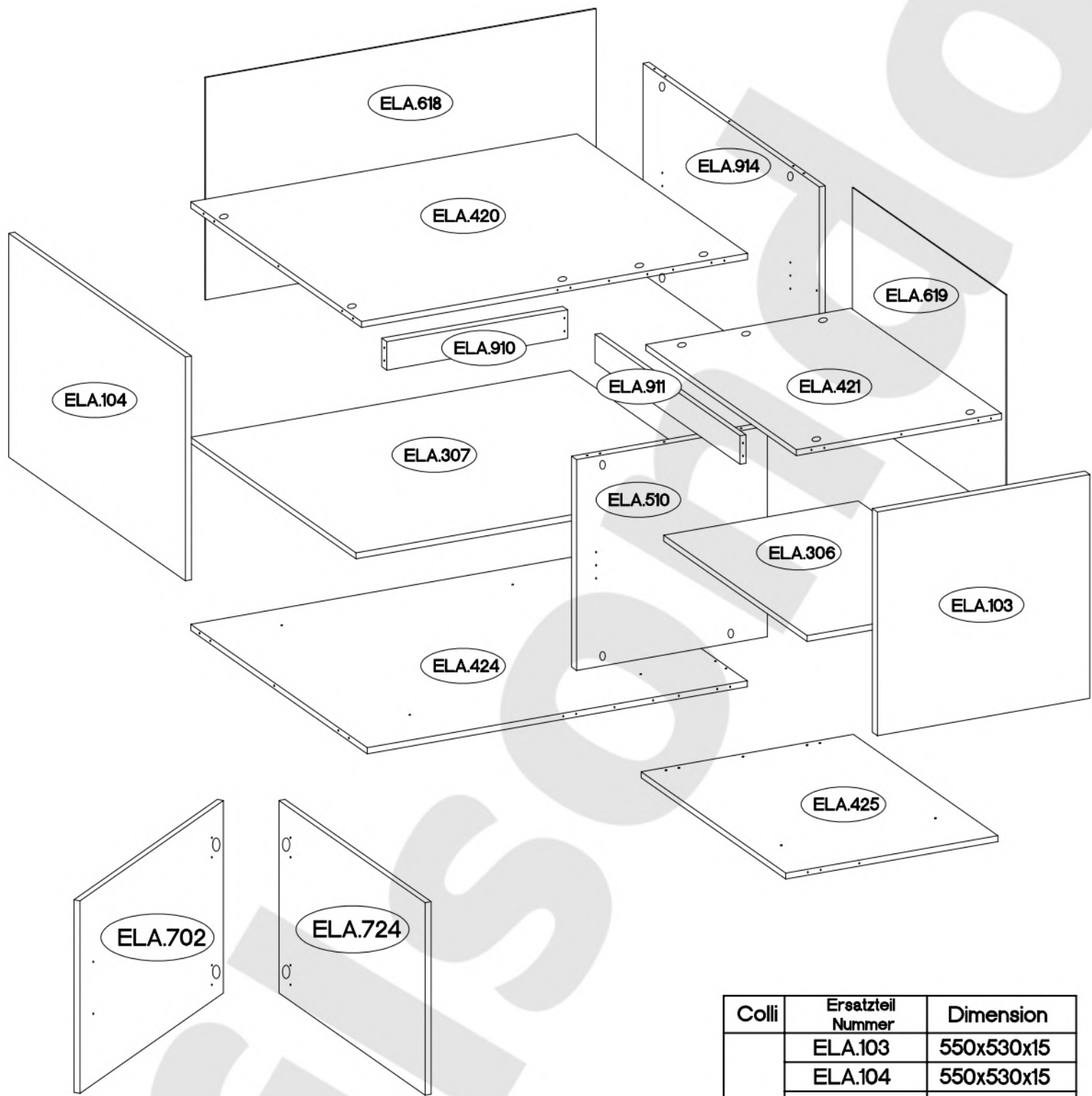



 A 29	 A2 8	 B 2	 C 28	 D2 16		
 D12 6	 E 8	 HG11 4	 J3 8	 J59 4	 M11 8	 O 1
 O11 1	 P1 2	 P5 58	 R 6	 R2 2	 S 1	 T3 1



P-ISM-ELA-18



Colli	Ersatzteil Nummer	Dimension
Colli 1/1	ELA.103	550x530x15
	ELA.104	550x530x15
	ELA.306	433x485x15
	ELA.307	947x495x15
	ELA.420	963x512x15
	ELA.421	451x512x15
	ELA.424	963x512x15
	ELA.425	451x512x15
	ELA.510	518x476x15
	ELA.618	546x974x2,5
	ELA.619	546x460x2,5
	ELA.702	473x430x15
	ELA.724	473x438x15
	ELA.910	451x70x15
ELA.911	435,5x70x15	
ELA.914	518x529x15	

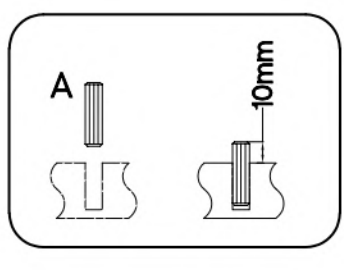
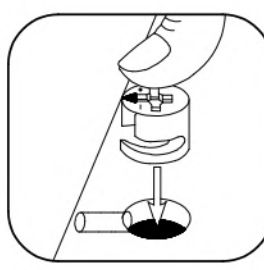
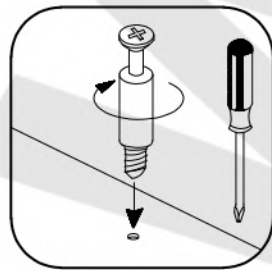
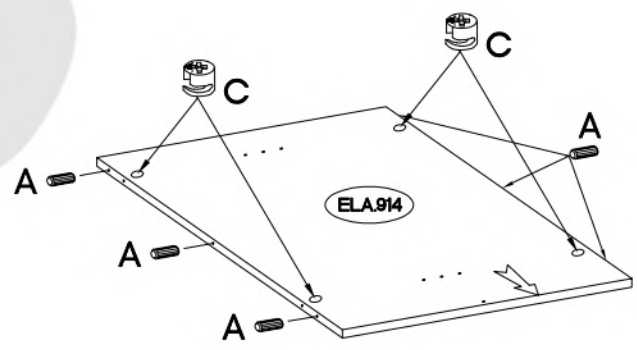
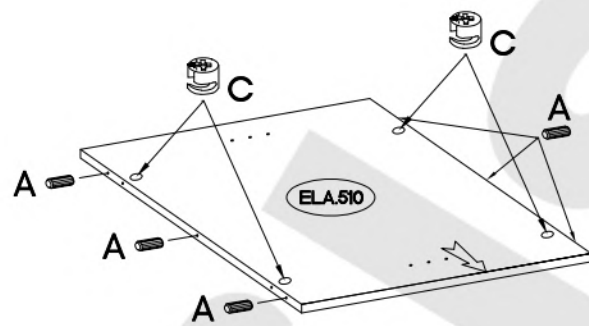
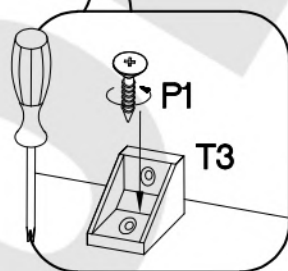
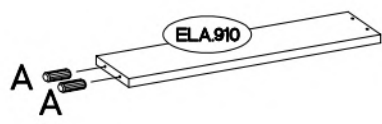
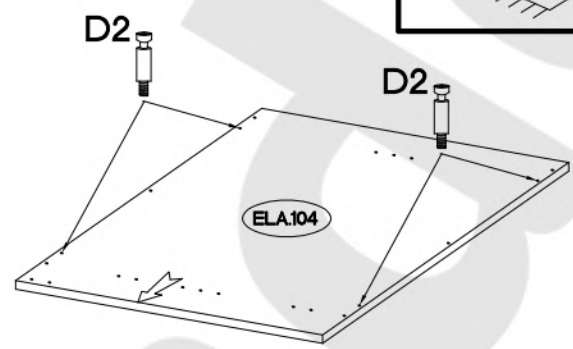
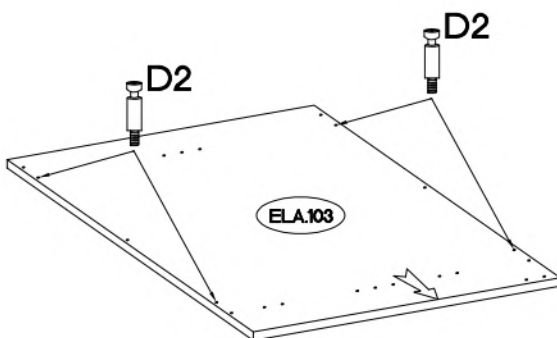
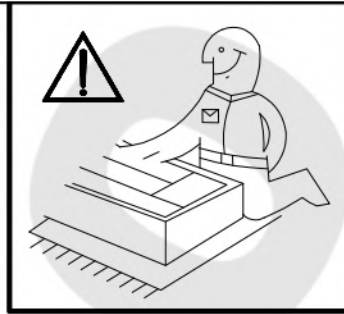

 <b>A</b> 17	 <b>C</b> 8	 <b>D2</b> 8	 <b>P1</b> 1	 <b>T3</b> 1
--	---	--	--	--

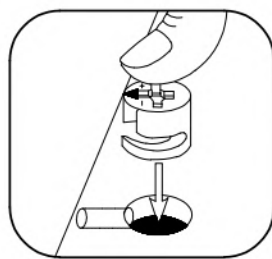
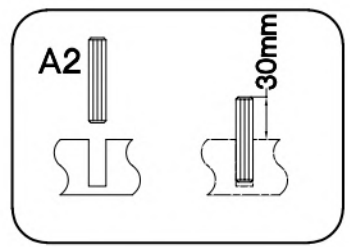
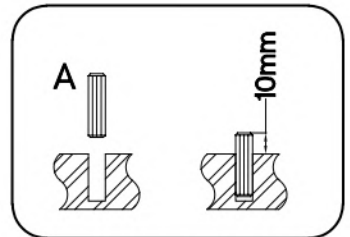
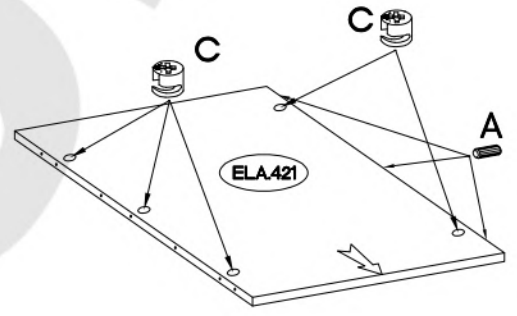
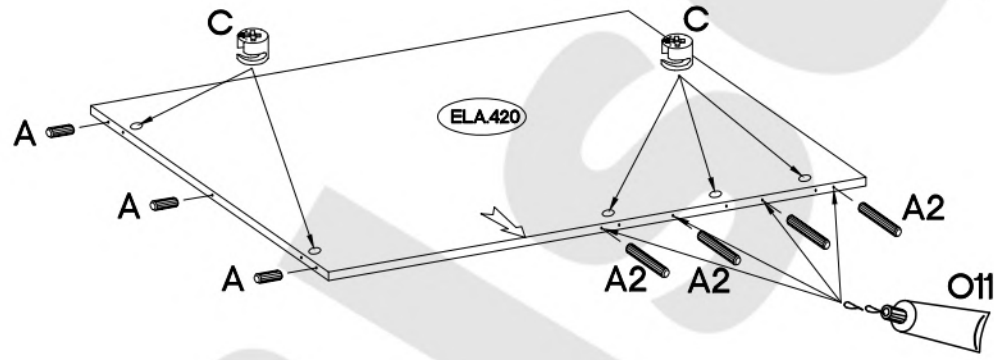
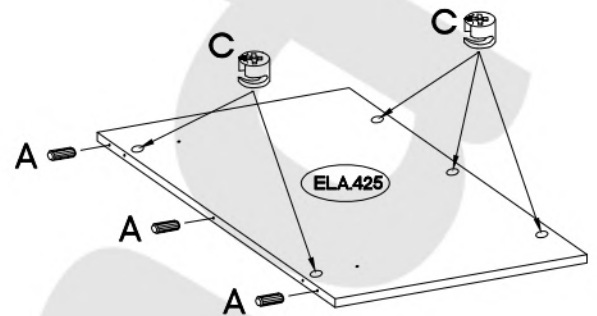
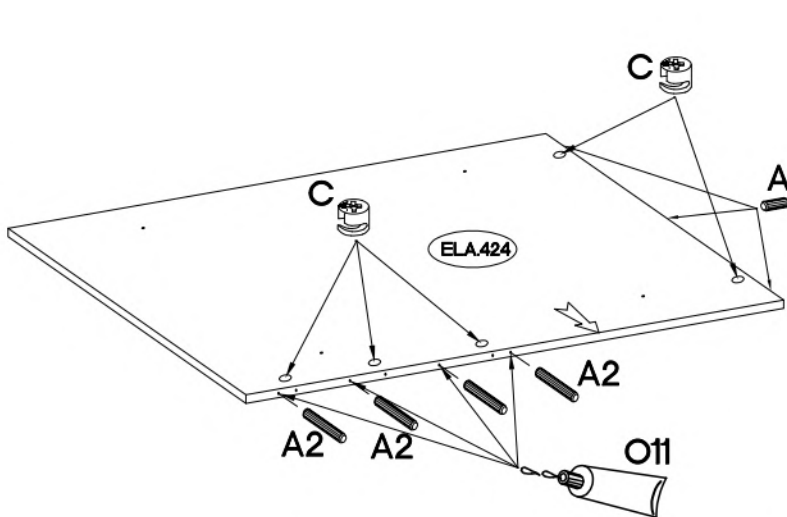
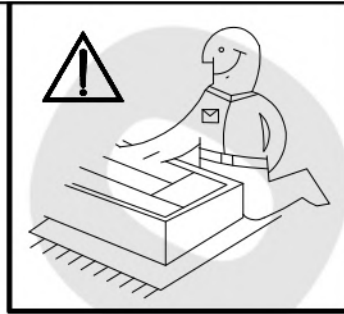

±8x30mm	±8x60mm	±15/12mm
		
A	A2	C
12	8	20



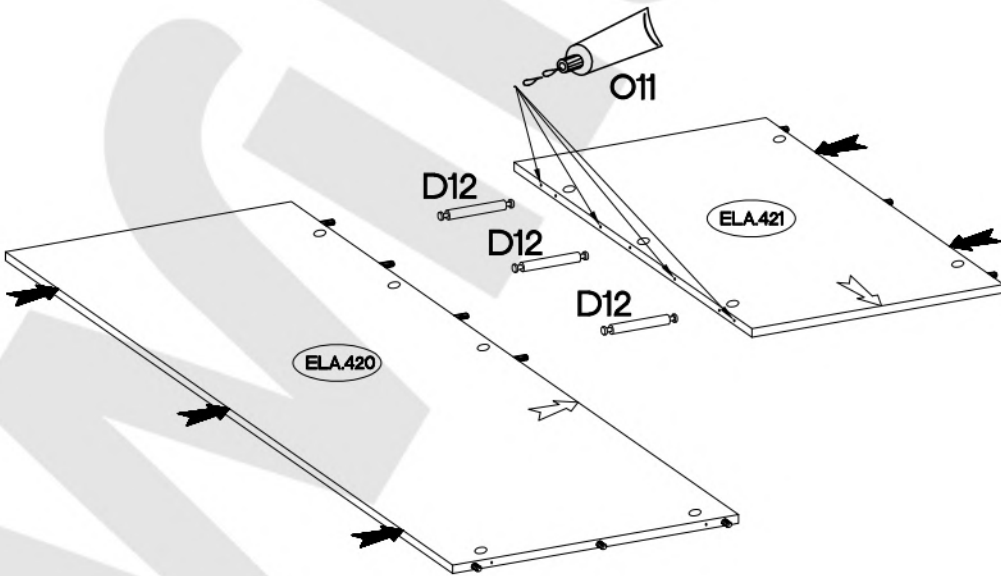
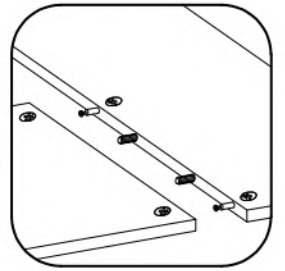
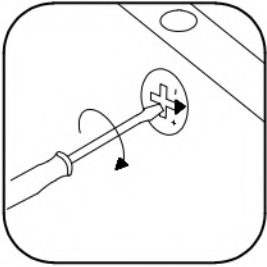
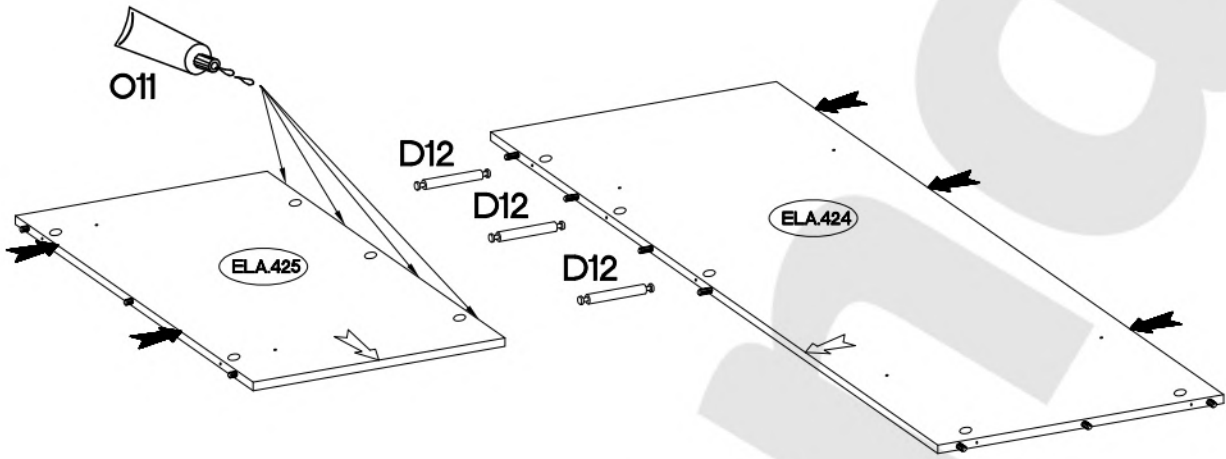
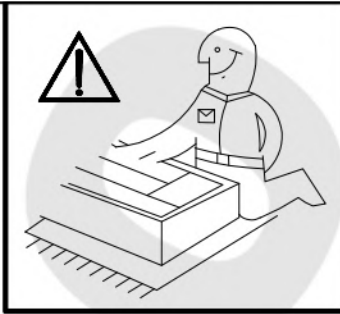
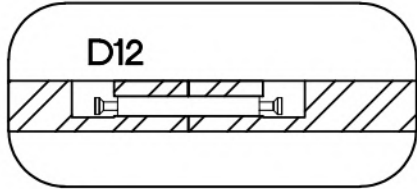

3

0,05  O11	L=40mm  D12
1	6



4

L=20mm  D2 8	6,4 x 50mm  B 1	 O 1
---	--	--

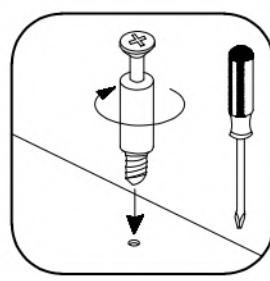
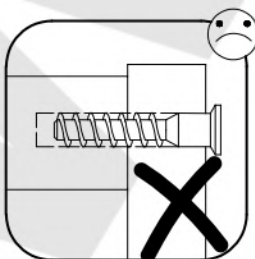
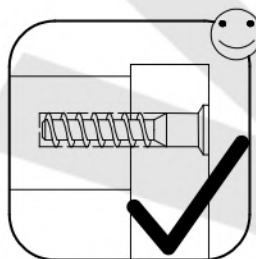
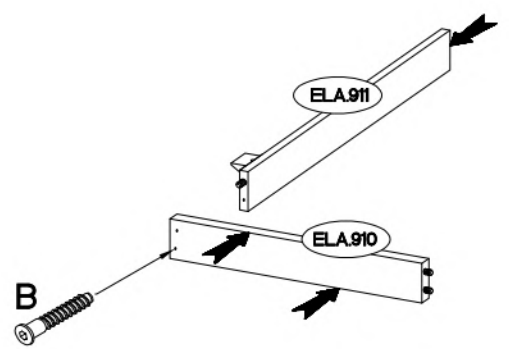
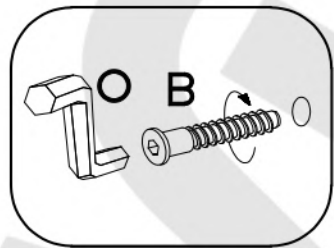
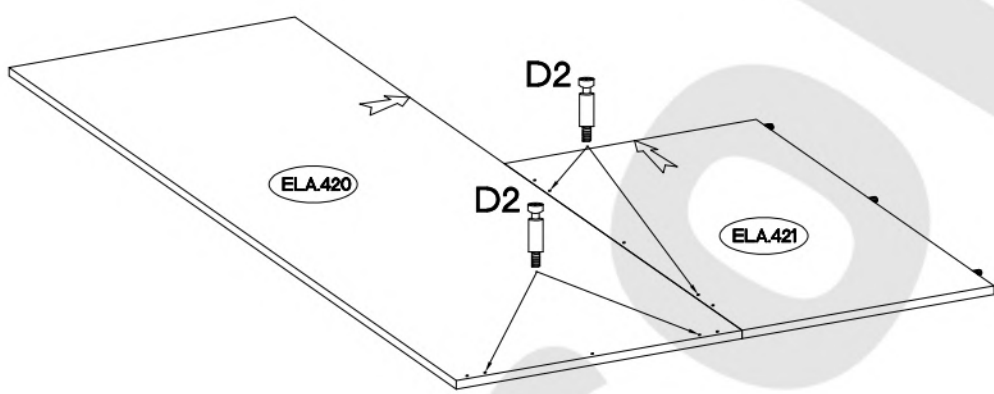
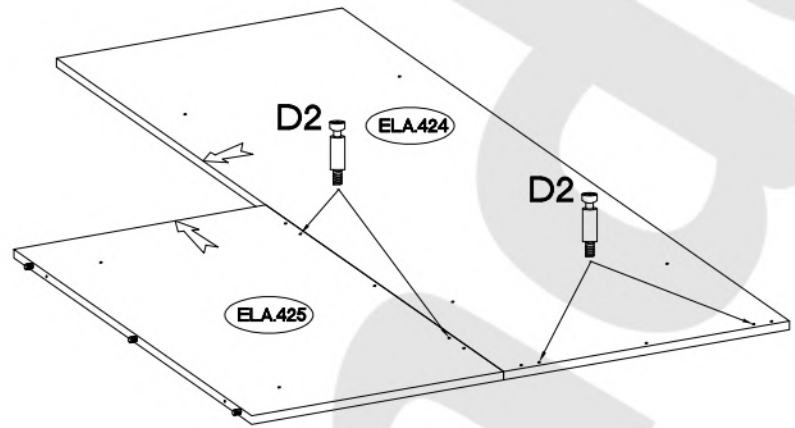
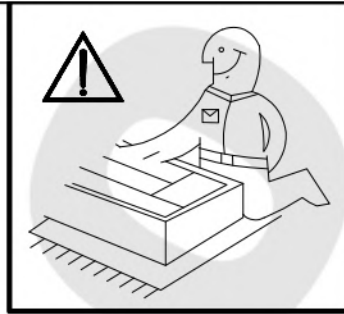

5

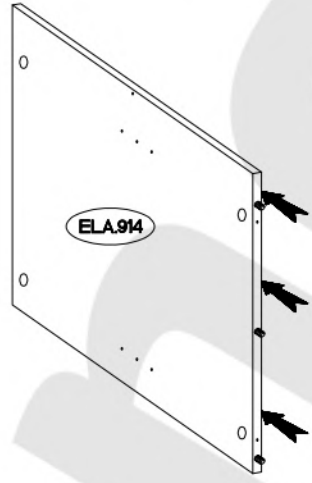
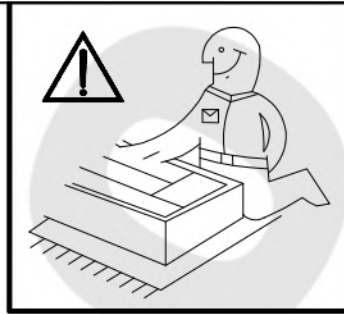
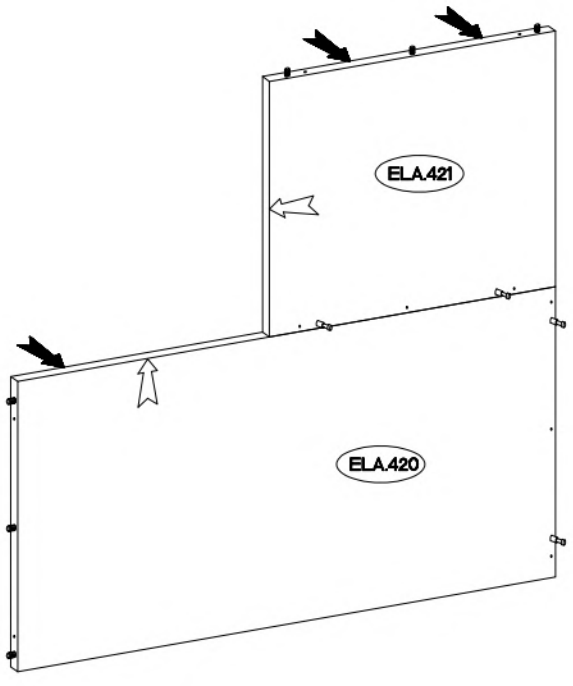

6

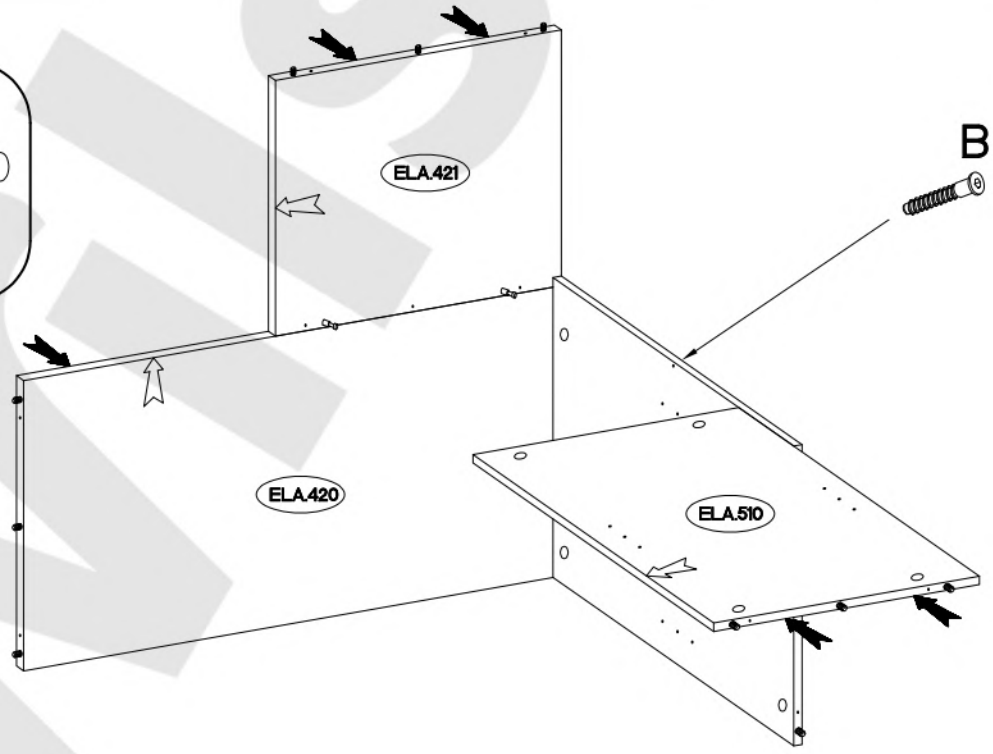
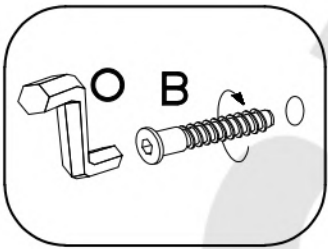
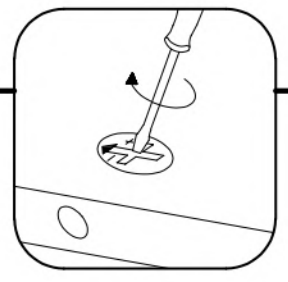
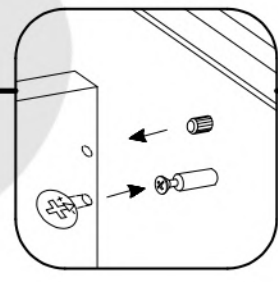
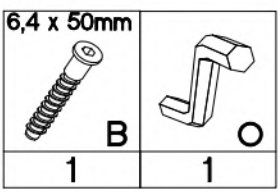

7

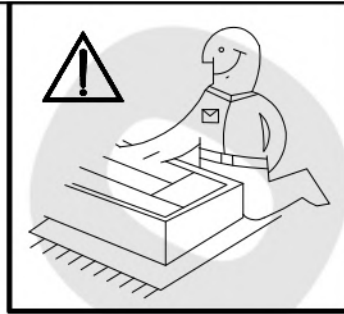
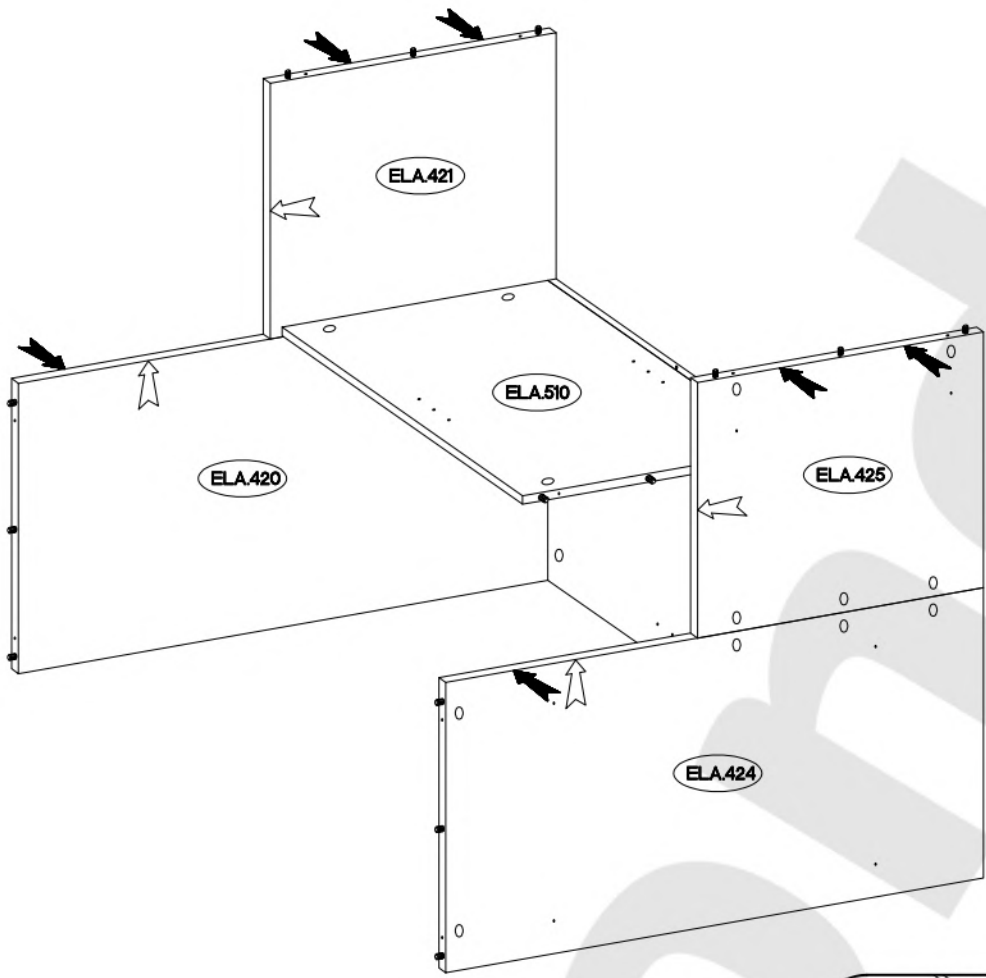

8

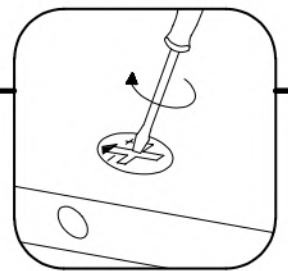
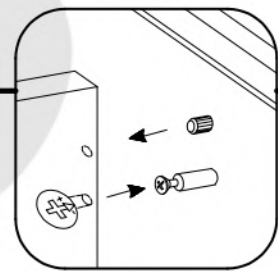
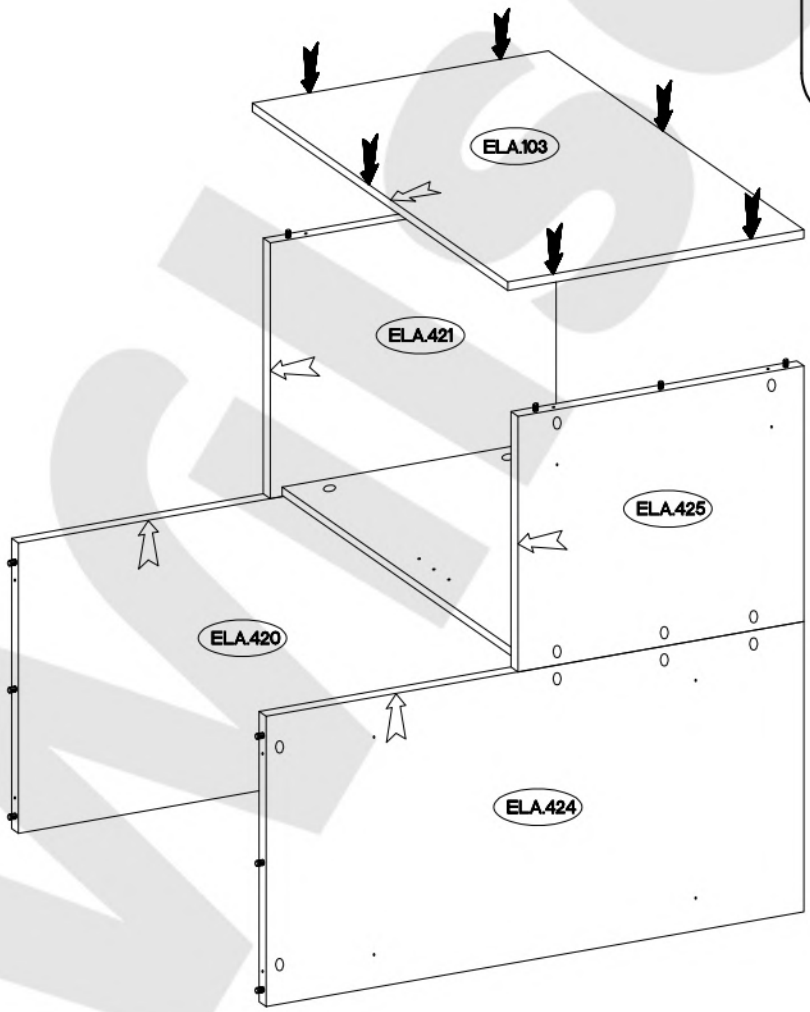



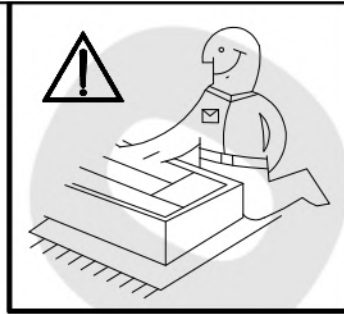
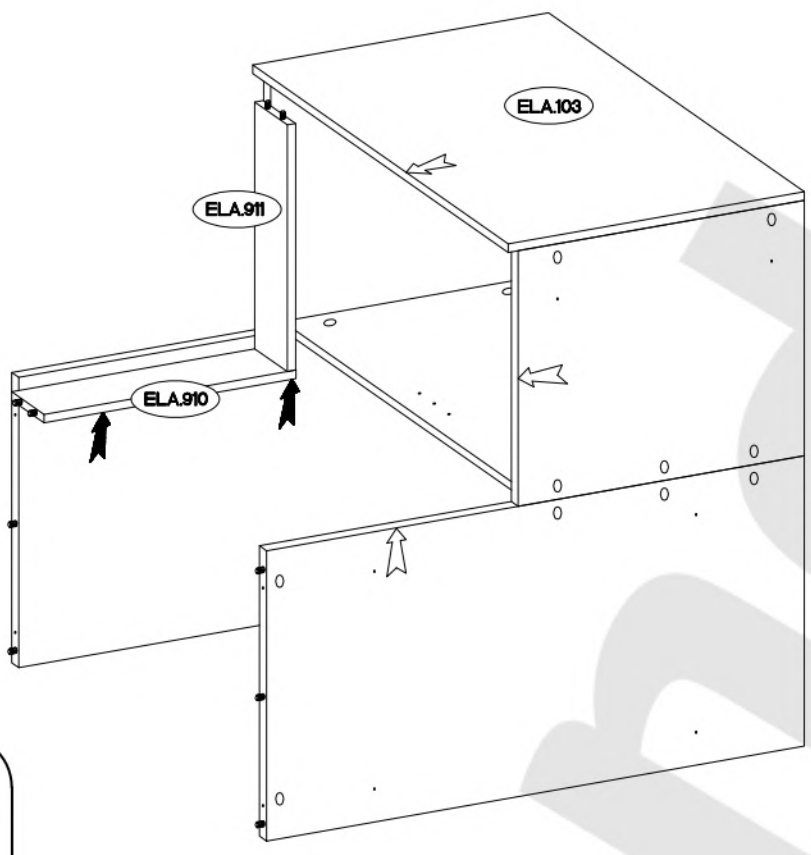

9

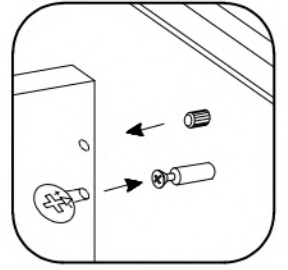
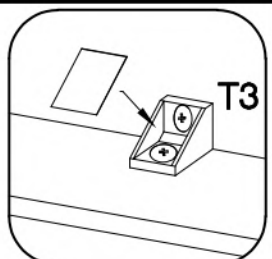
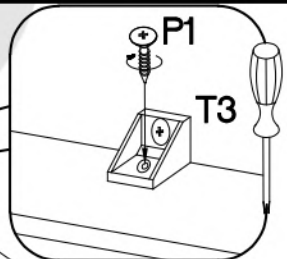
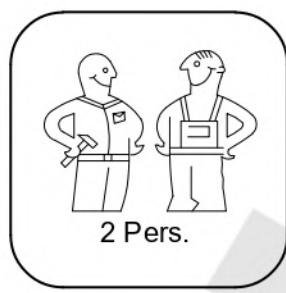
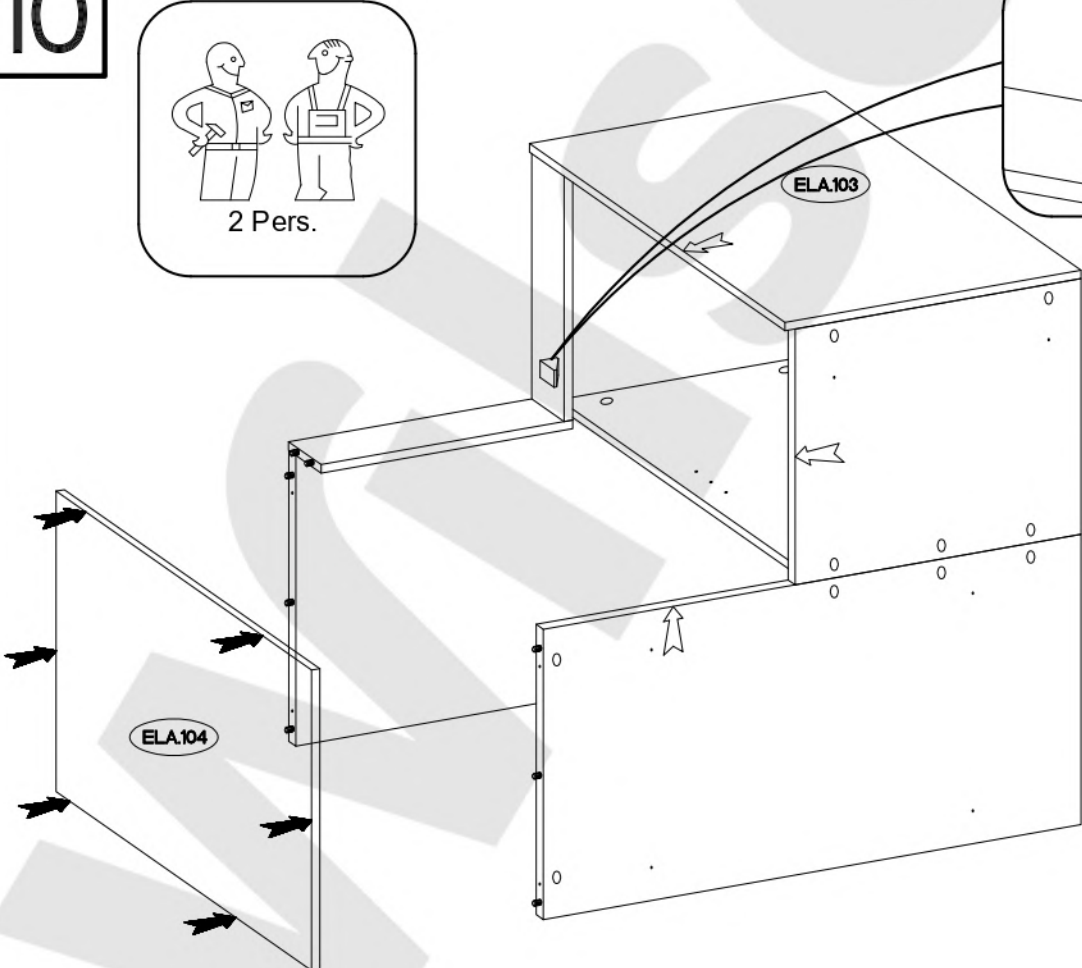

10



11

±5/16mm

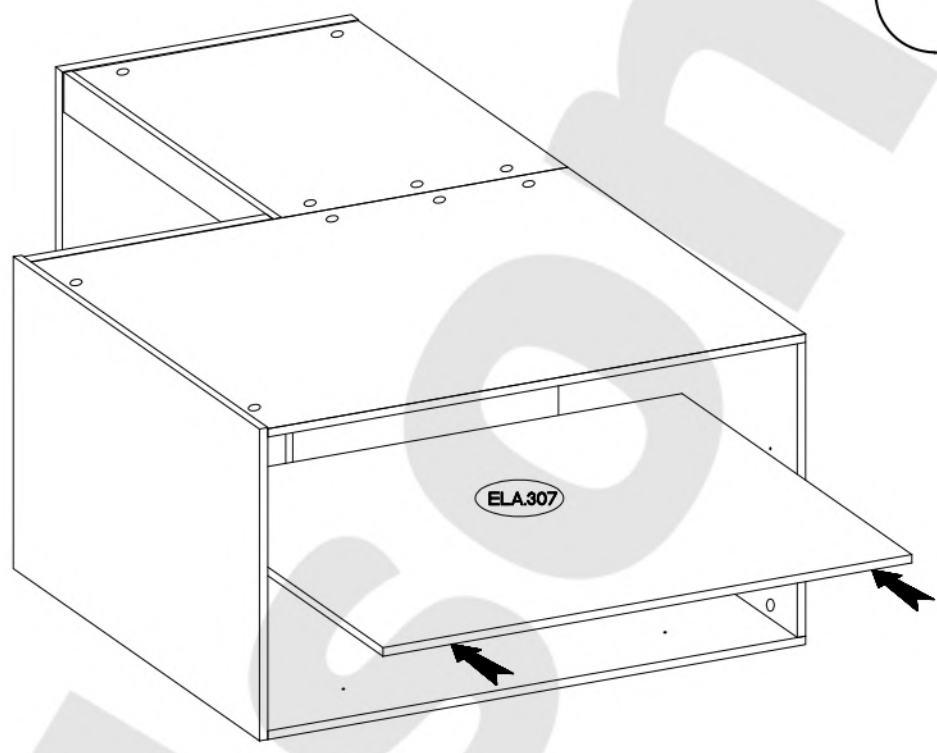
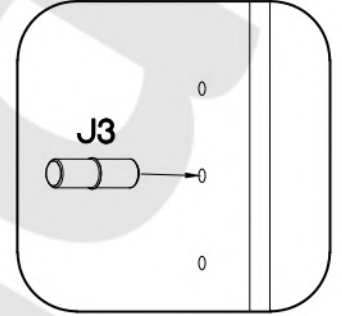
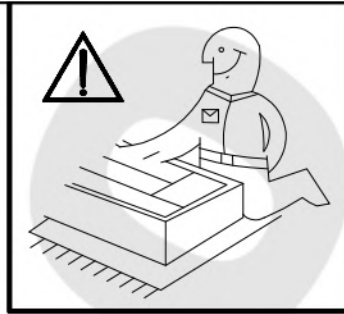
J3
4



11

±3.5x13mm



P5

20-25

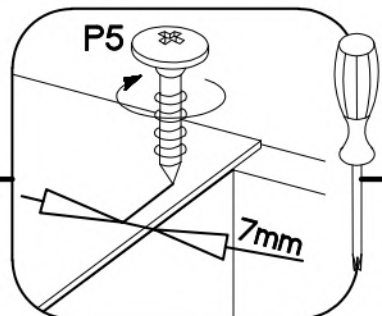
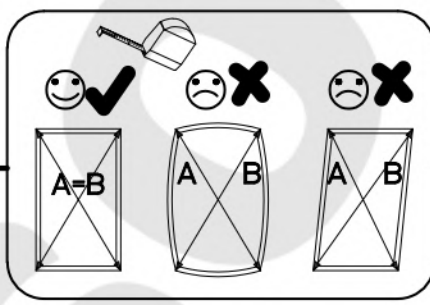
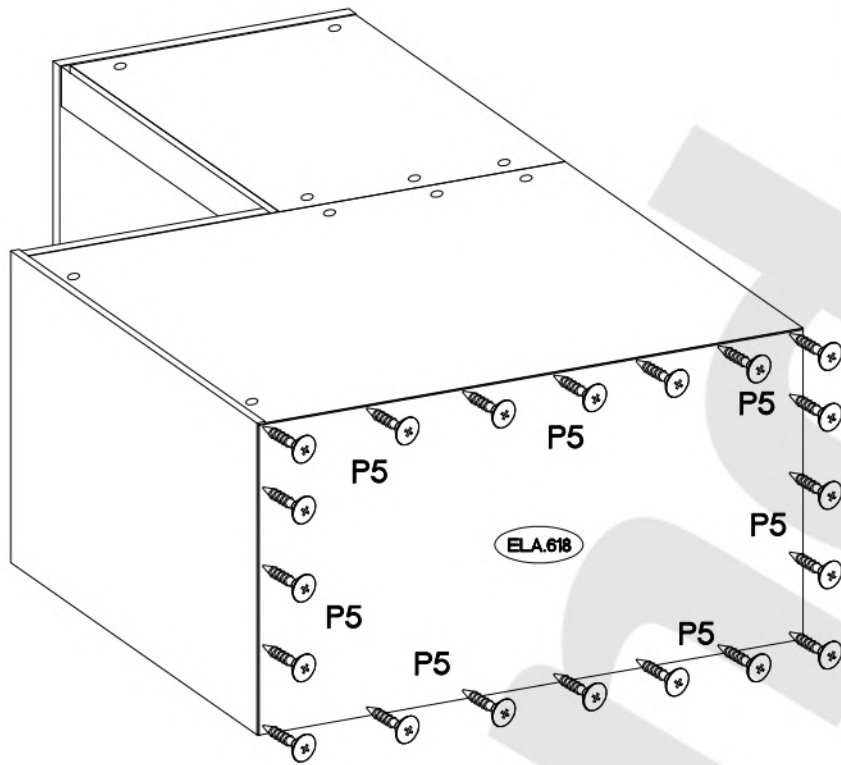
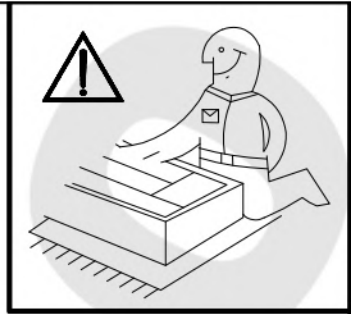

12

±3.5x13mm





P5

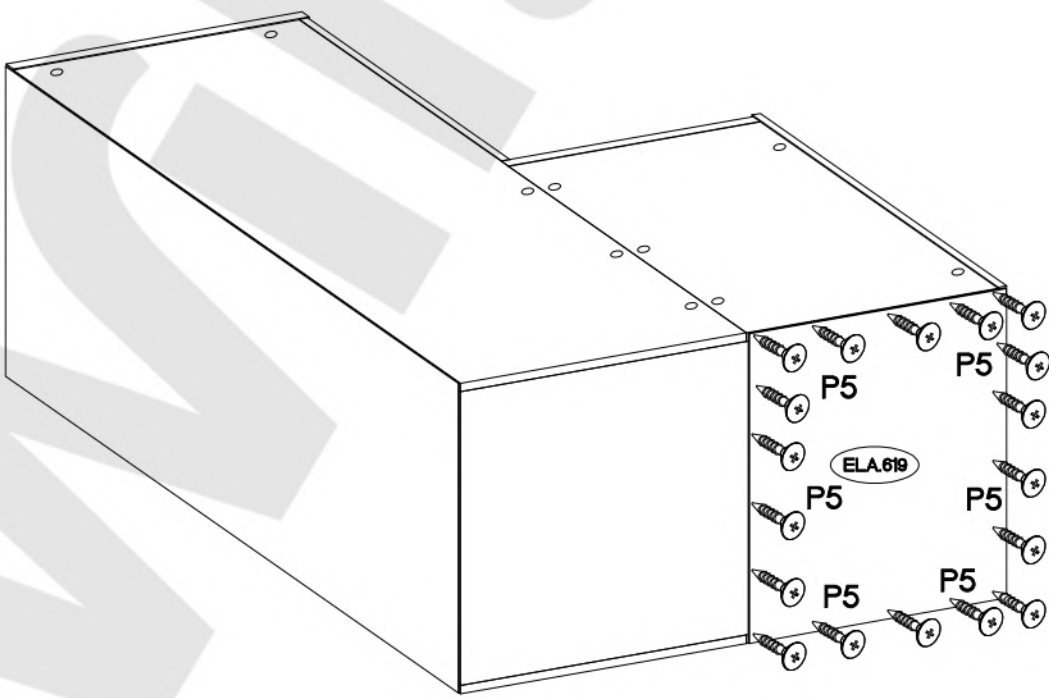

20-25

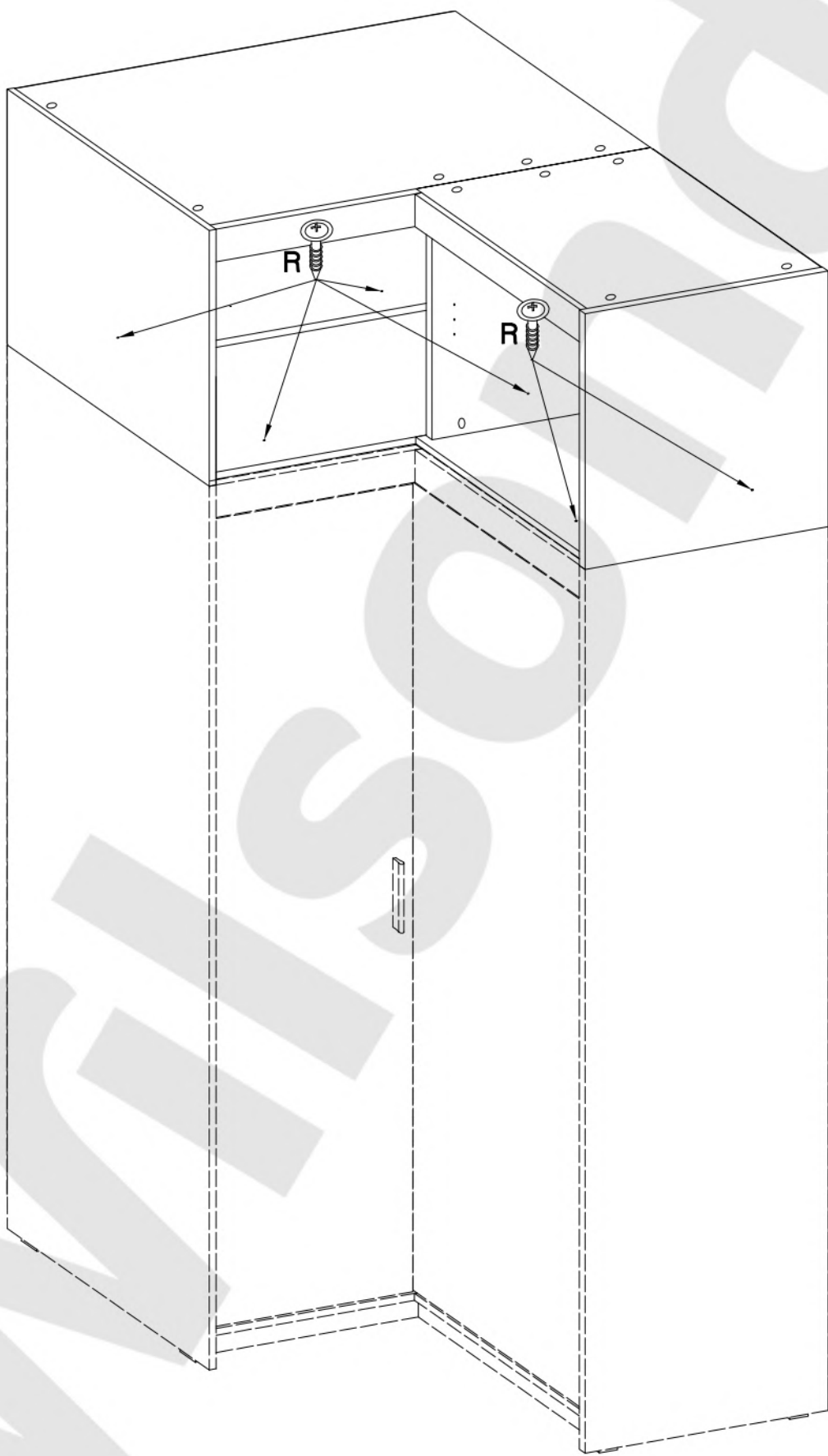

4.0x25mm  
R  
6





14

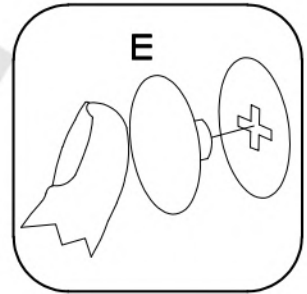
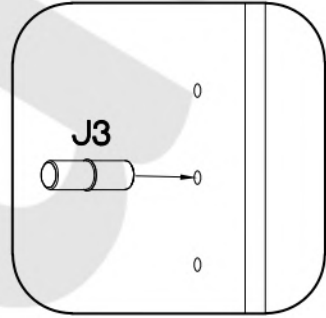
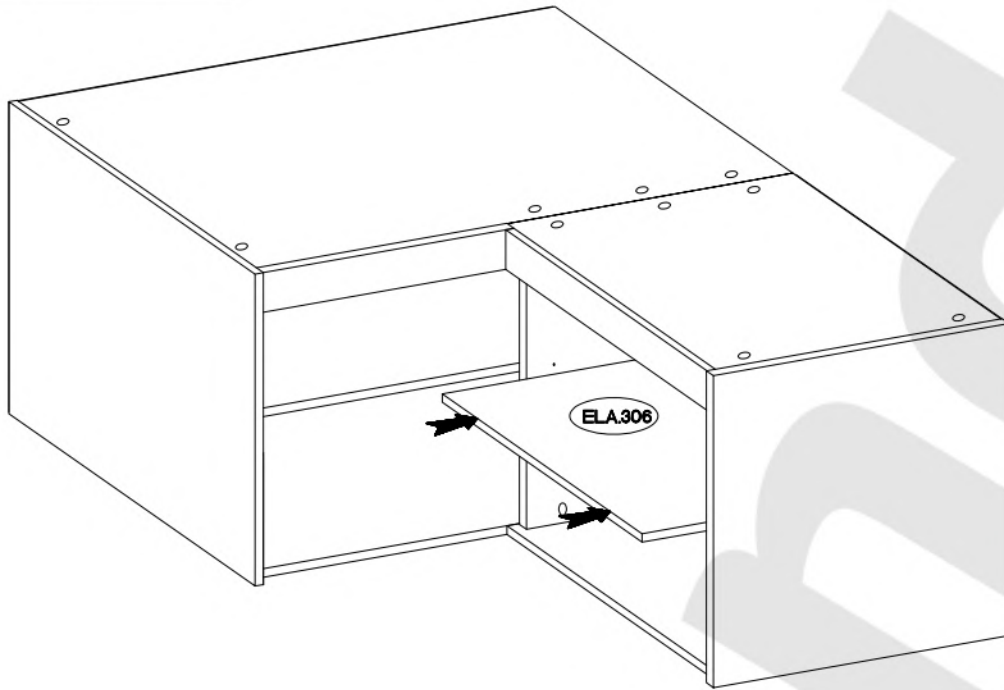
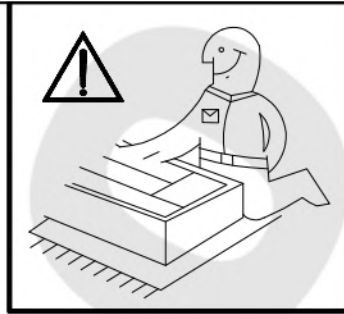



$\pm 5/16\text{mm}$		
	J3	E
4		8

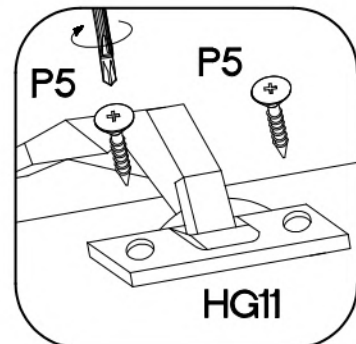
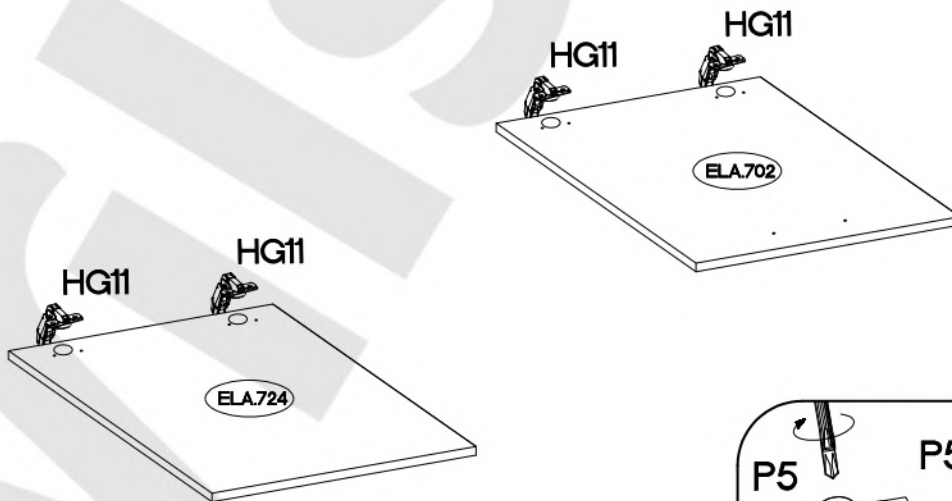

15

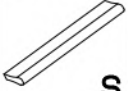
$\pm 35/175$	$\pm 3.5 \times 13\text{mm}$
	
HG11	P5
4	8



L=128mm  S	+4.0x30mm  R2	+6.3x30mm  M11	H=16mm  J59
1	2	8	4

