

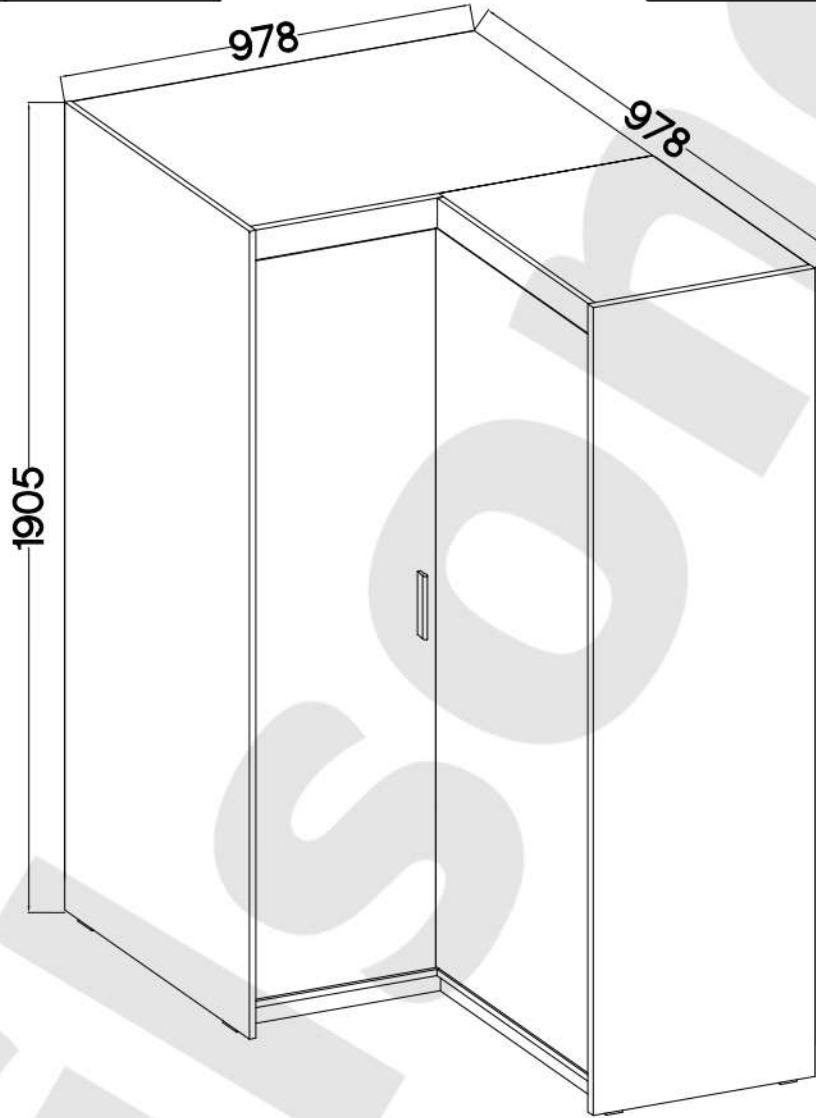

























240 min

ELENA 2D NAR



 A	 A2	 B	 C	 D2	 D12	 E	 F2	 F4
48	12	6	40	22	9	15	6	3
 HG11	 J2	 J3	 J17	 J59	 L19	 M11	 O	 O7
6	1	12	2	6	1	12	1	1
 O11	 P1	 P5	 P12	 R2	 S	 T3		
1	2	126	1	2	1	1		

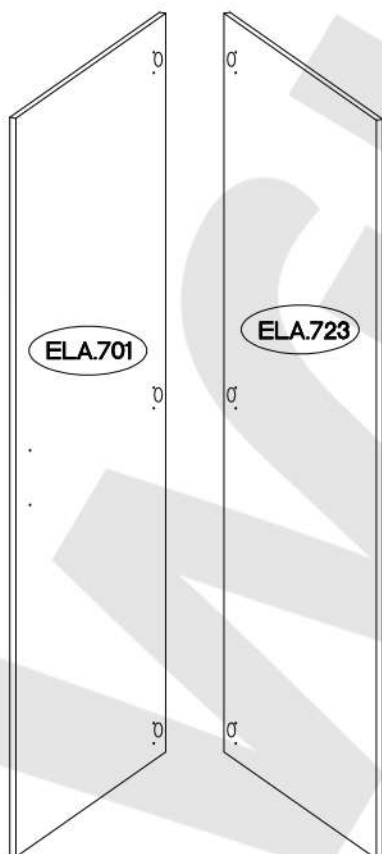
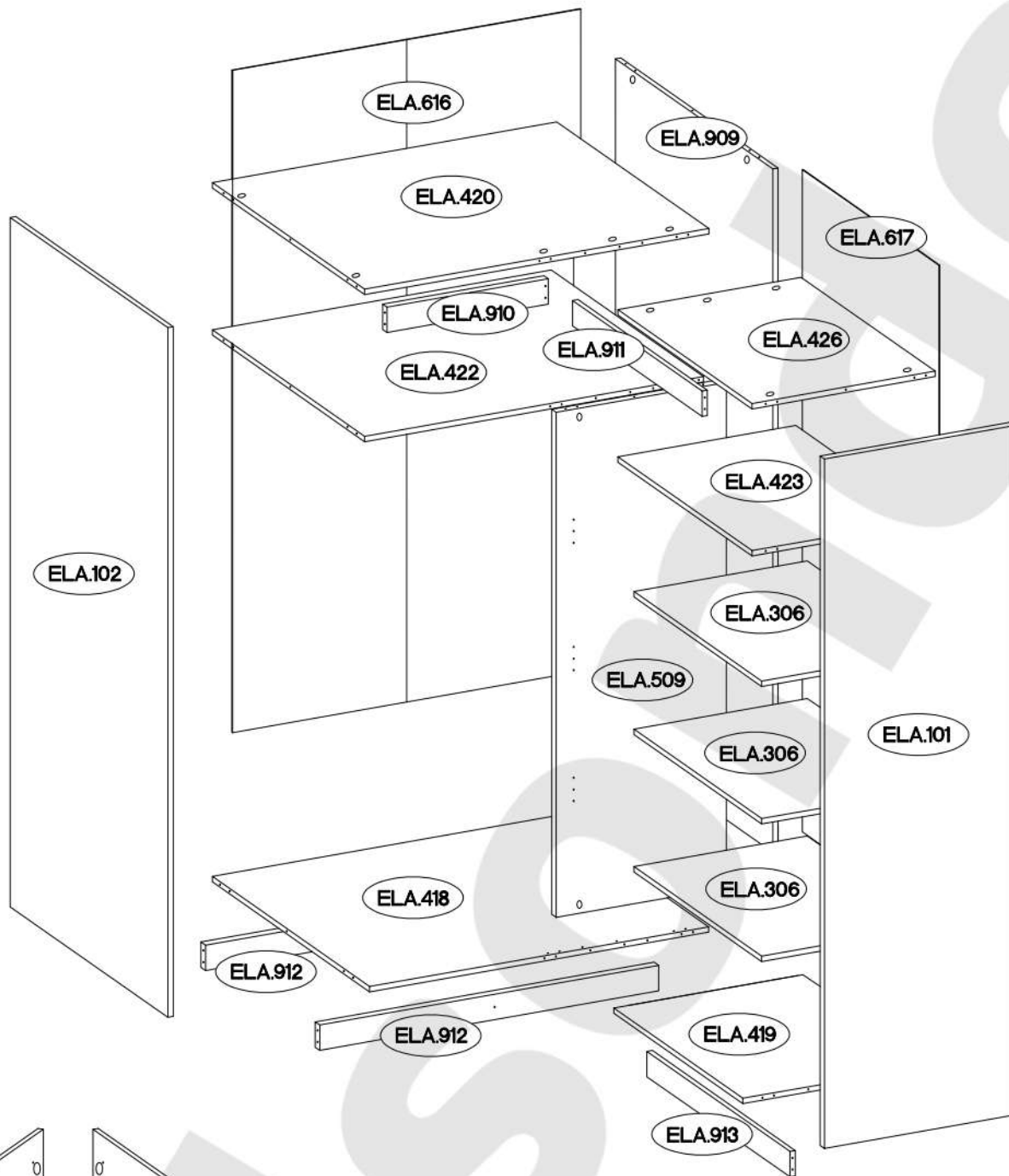





ELA.422
ELA.423

ELA.306





Colli	Ersatzteil Nummer	Dimension
Colli 3/3	ELA.509	1391.5x476x15
	ELA.616	1825x974x2,5
	ELA.617	1825x460x2,5
	ELA.701	1737x430x15
	ELA.723	1737x438x15

Colli	Ersatzteil Nummer	Dimension
Colli 1/3	ELA.306 x3	433x485x15
	ELA.418	948x529x15
	ELA.419	434x529x15
	ELA.420	963x512x15
	ELA.426	451x512x15
	ELA.422	948x512x15
	ELA.423	451x497x15
	ELA.910	451x70x15
	ELA.911	435x70x15
	ELA.912 x2	948x70x15
	ELA.913	481x70x15

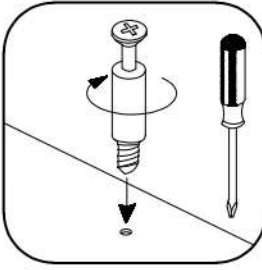
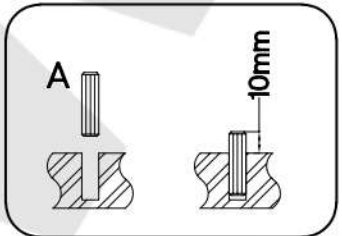
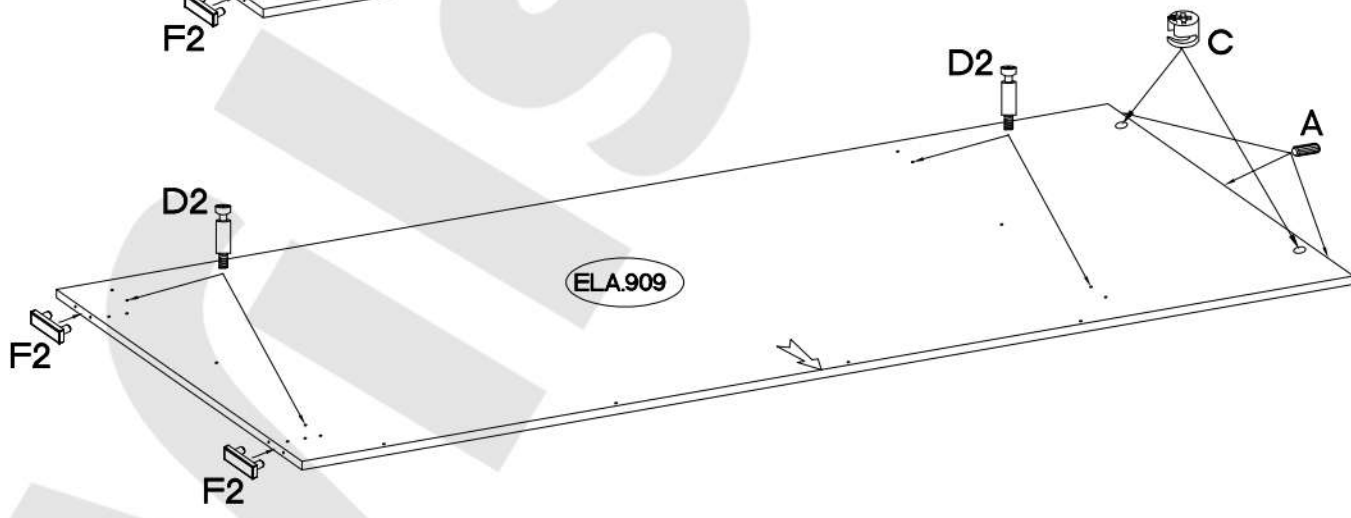
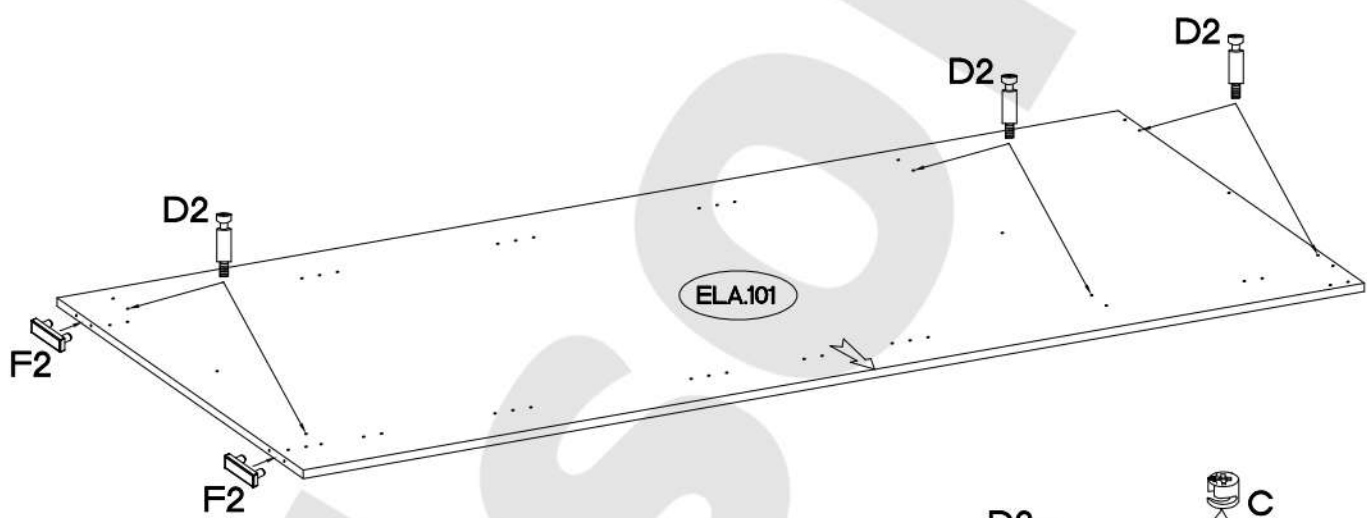
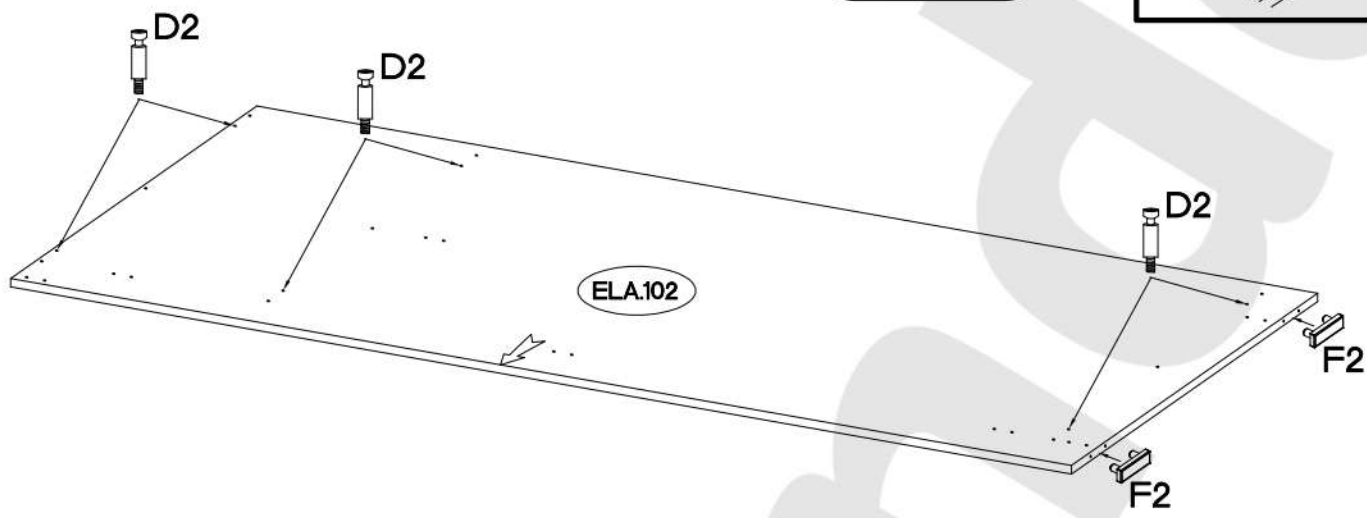
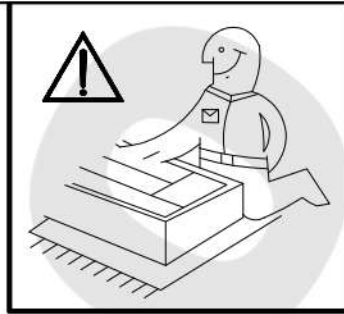
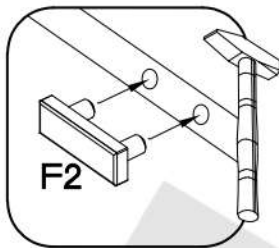



Colli	Ersatzteil Nummer	Dimension
Colli 2/3	ELA.101	1900x530x15
	ELA.102	1900x530x15
	ELA.909	1883x529x15

 A 3	 C 2	 D2 16	 F2 6
--	--	--	---

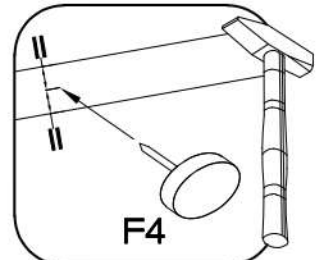
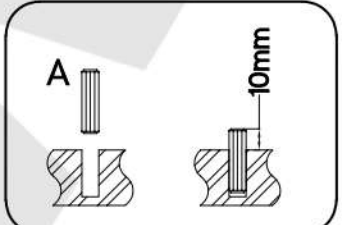
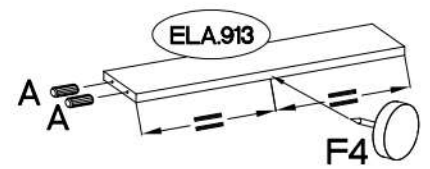
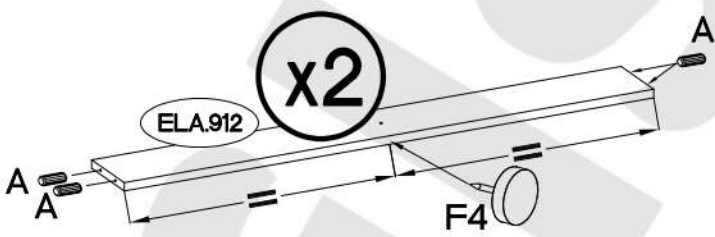
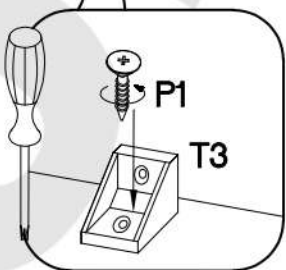
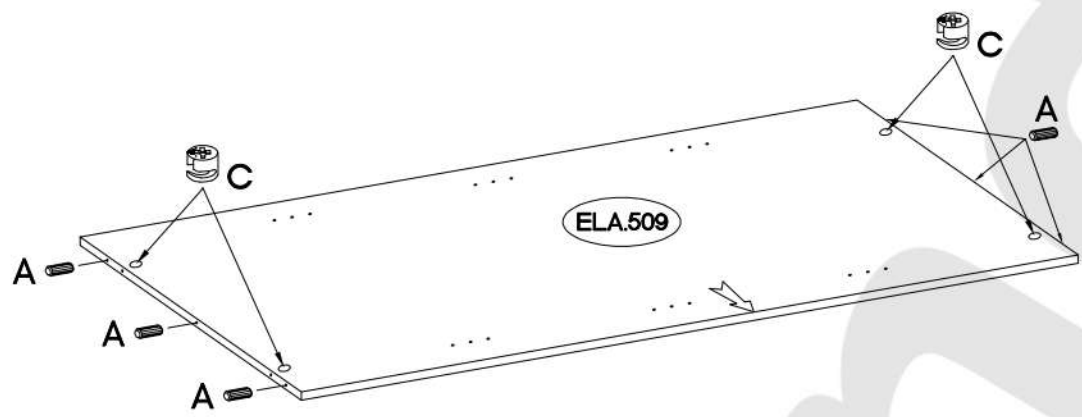
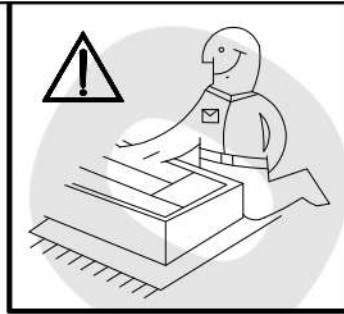



∅8x30mm	∅15/12mm	∅15x5mm	∅4.0x16mm	
				
A	C	F4	P1	T3
21	4	3	1	1

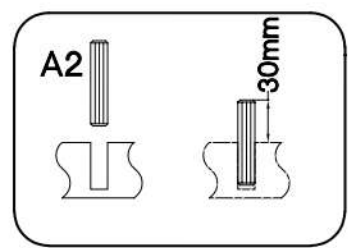
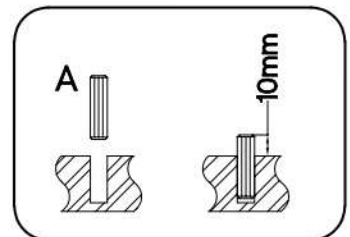
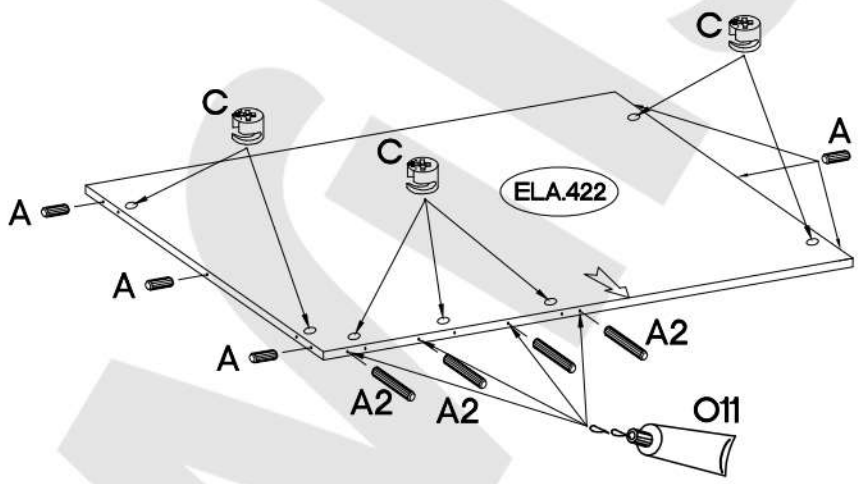
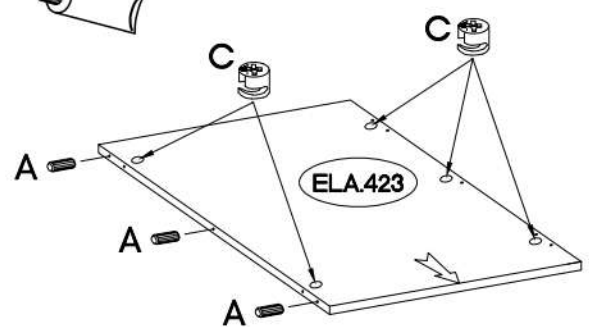
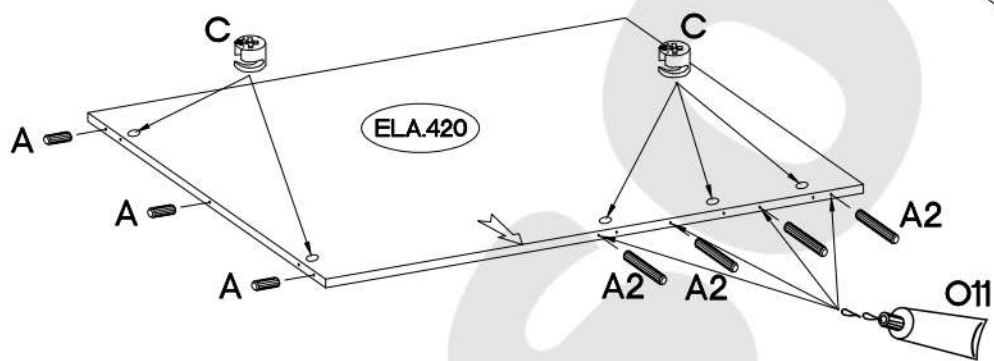
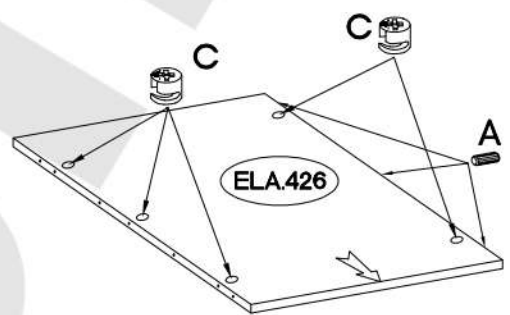
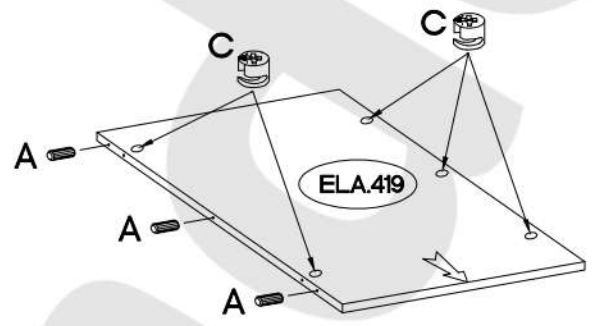
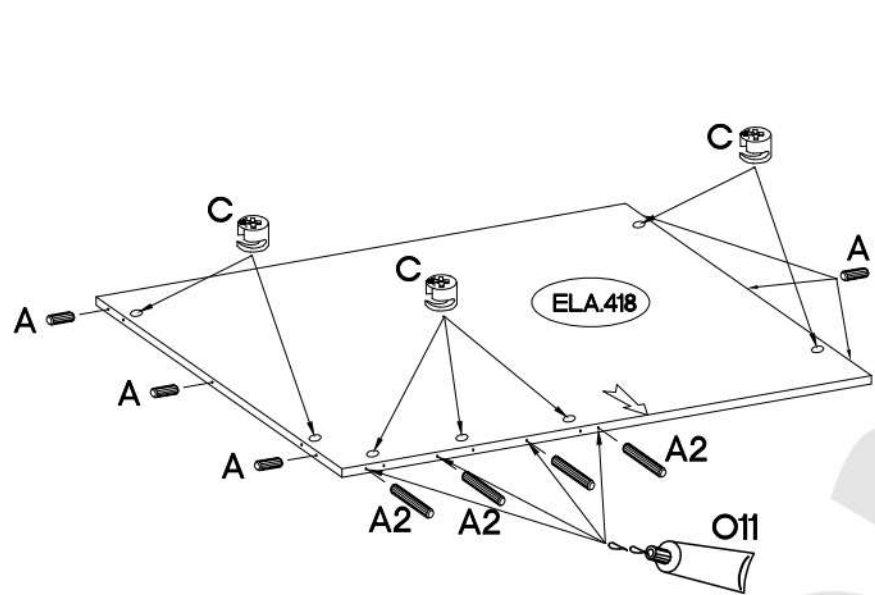
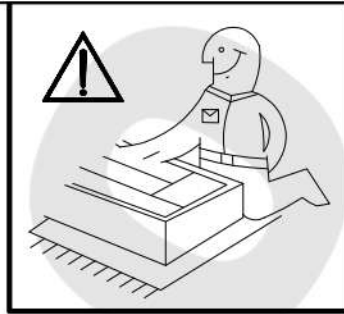

$\varnothing 8 \times 30 \text{mm}$  A 24	$\varnothing 8 \times 60 \text{mm}$  A2 12	$\varnothing 15 / 12 \text{mm}$  C 34	0,05  O11 1
--	---	--	--



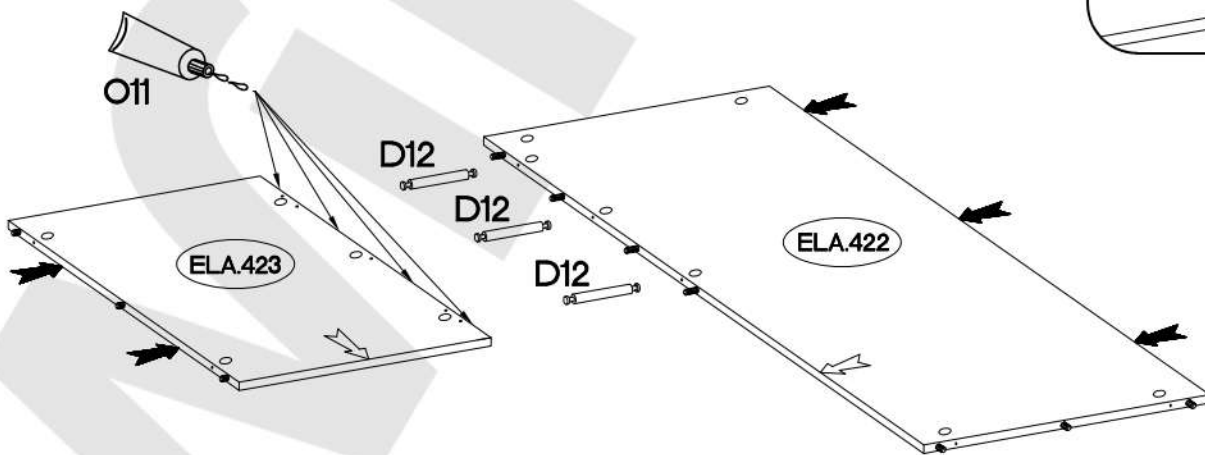
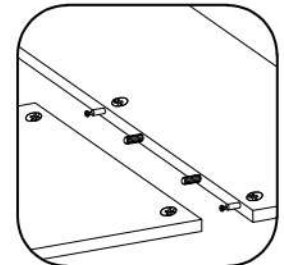
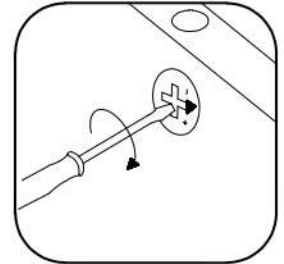
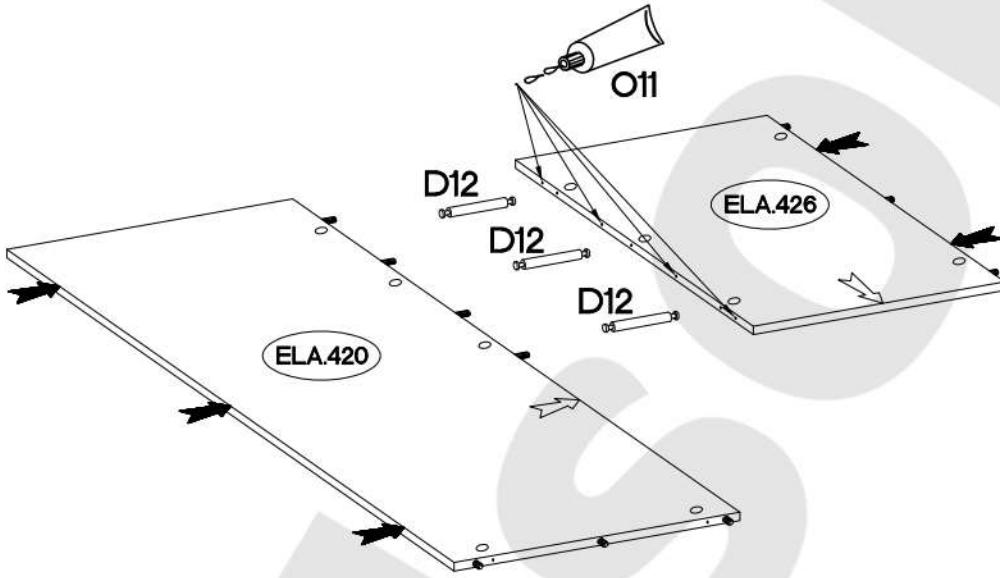
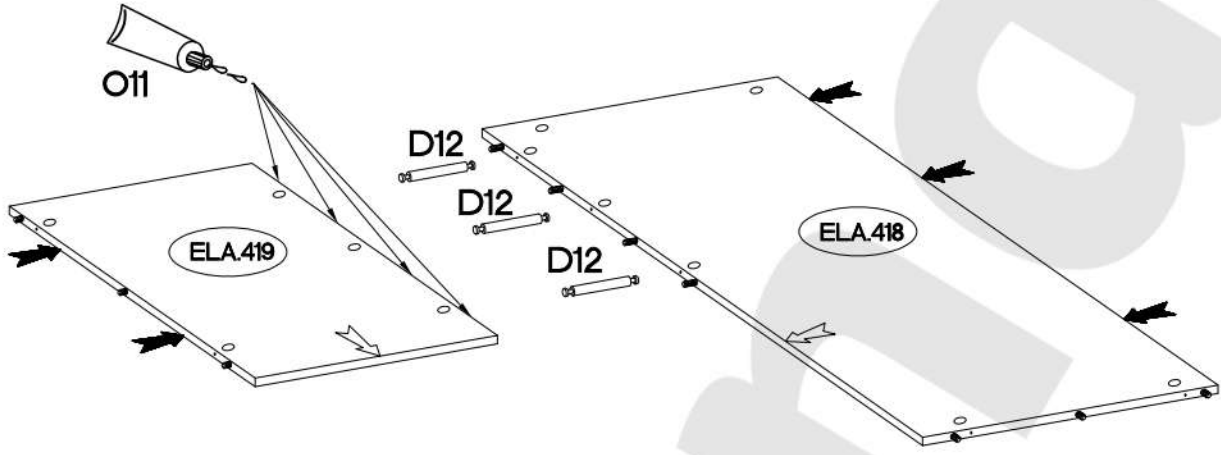
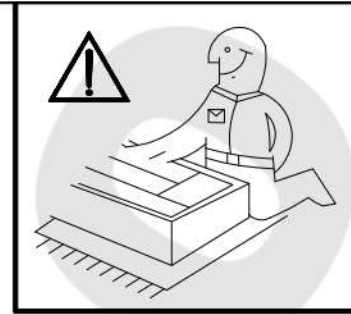
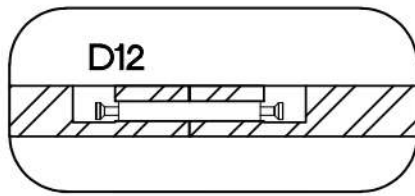

4

0,05  O11	L=40mm  D12
1	9



5

L=20mm  D2 6	6,4 x 50mm  B 1	 O 1
---	--	--

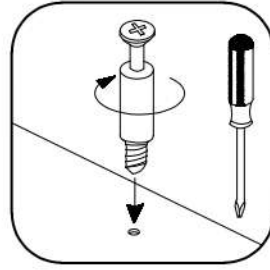
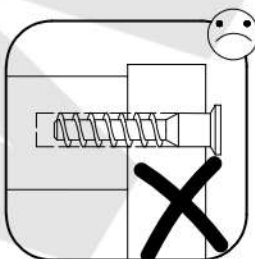
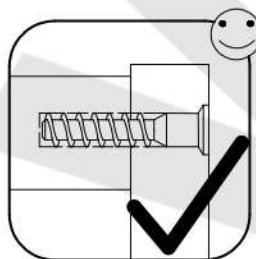
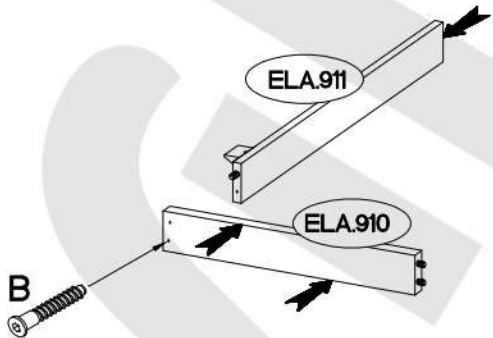
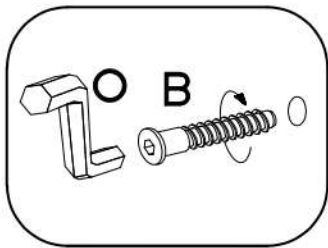
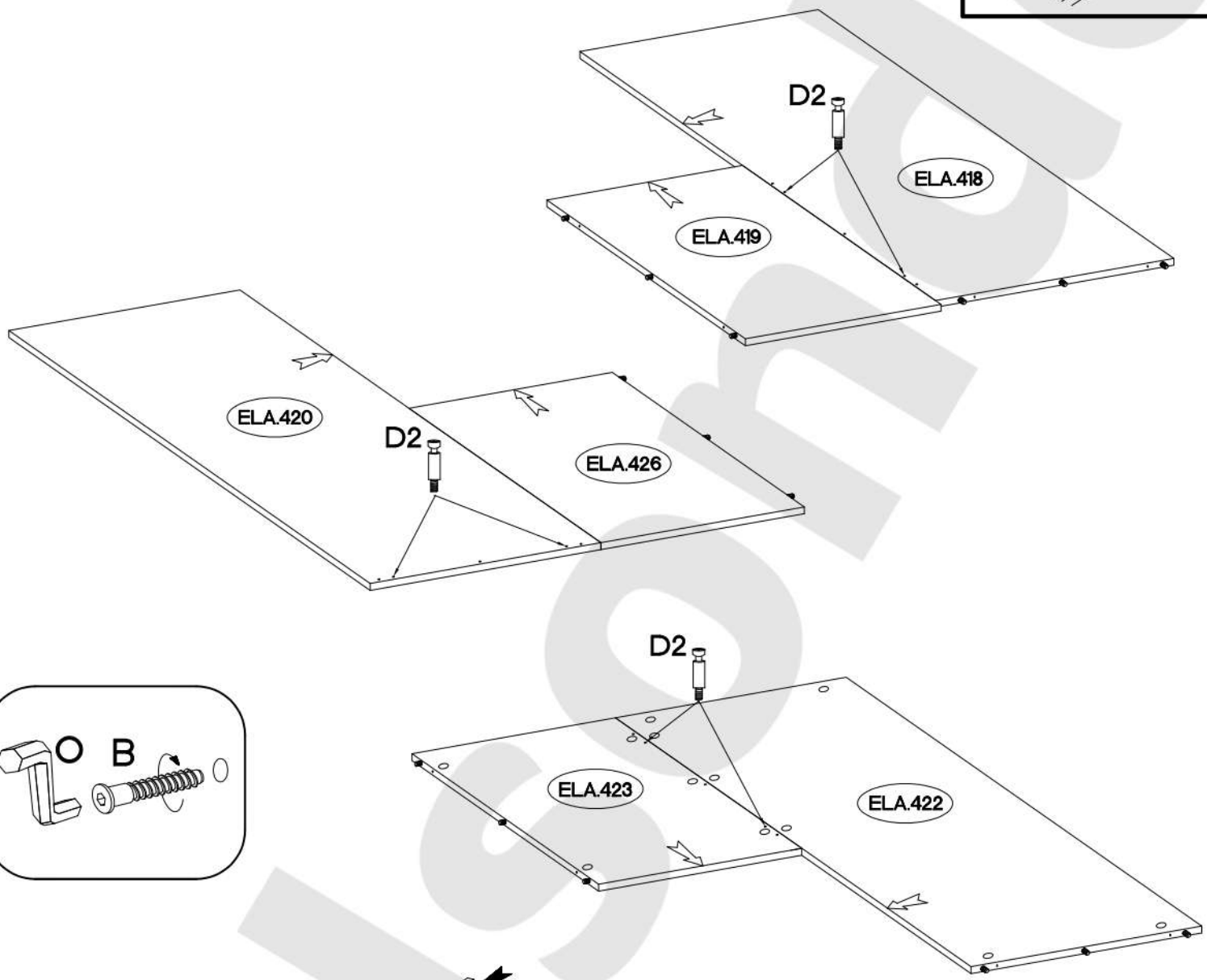
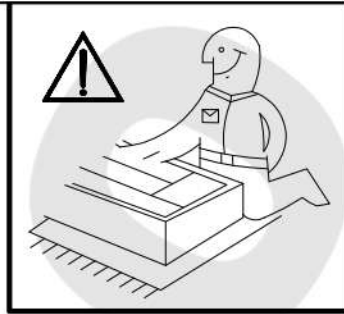

6

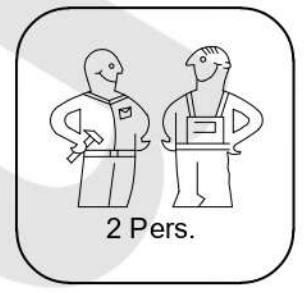
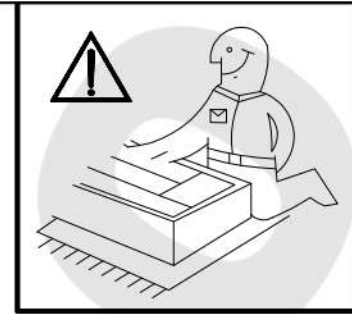
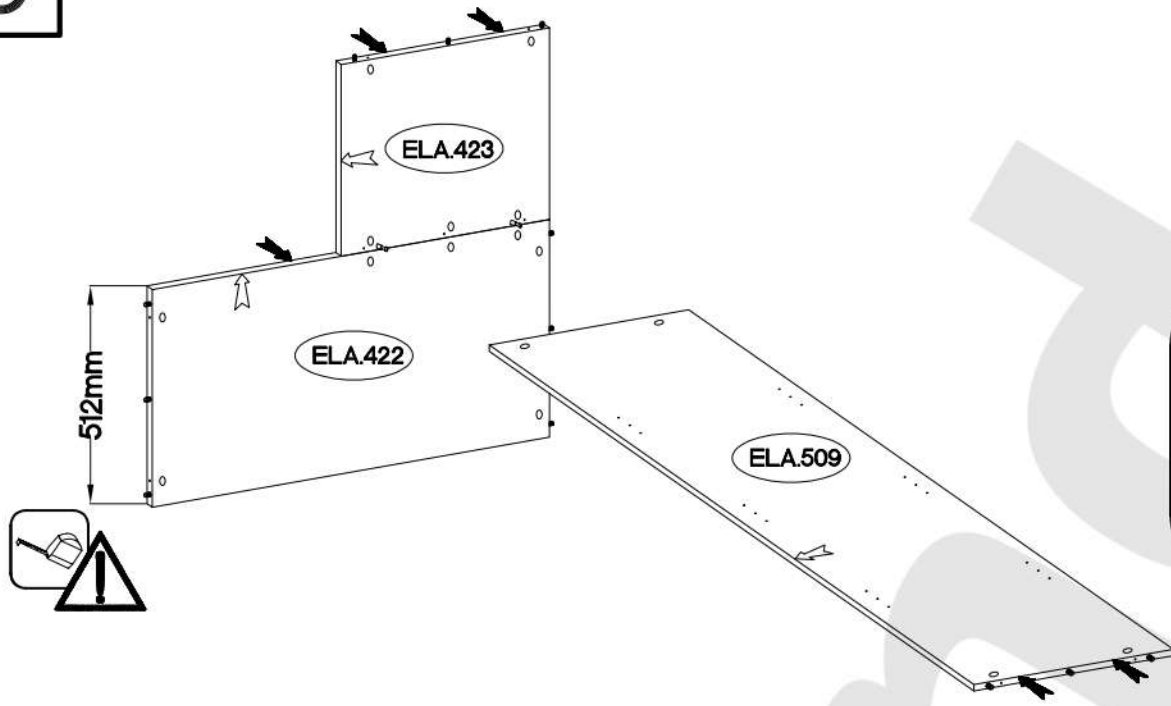

7

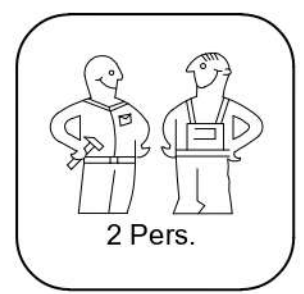
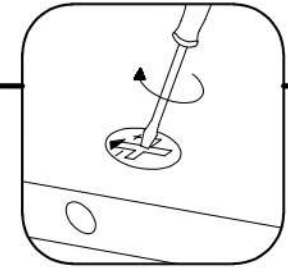
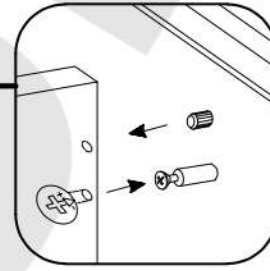
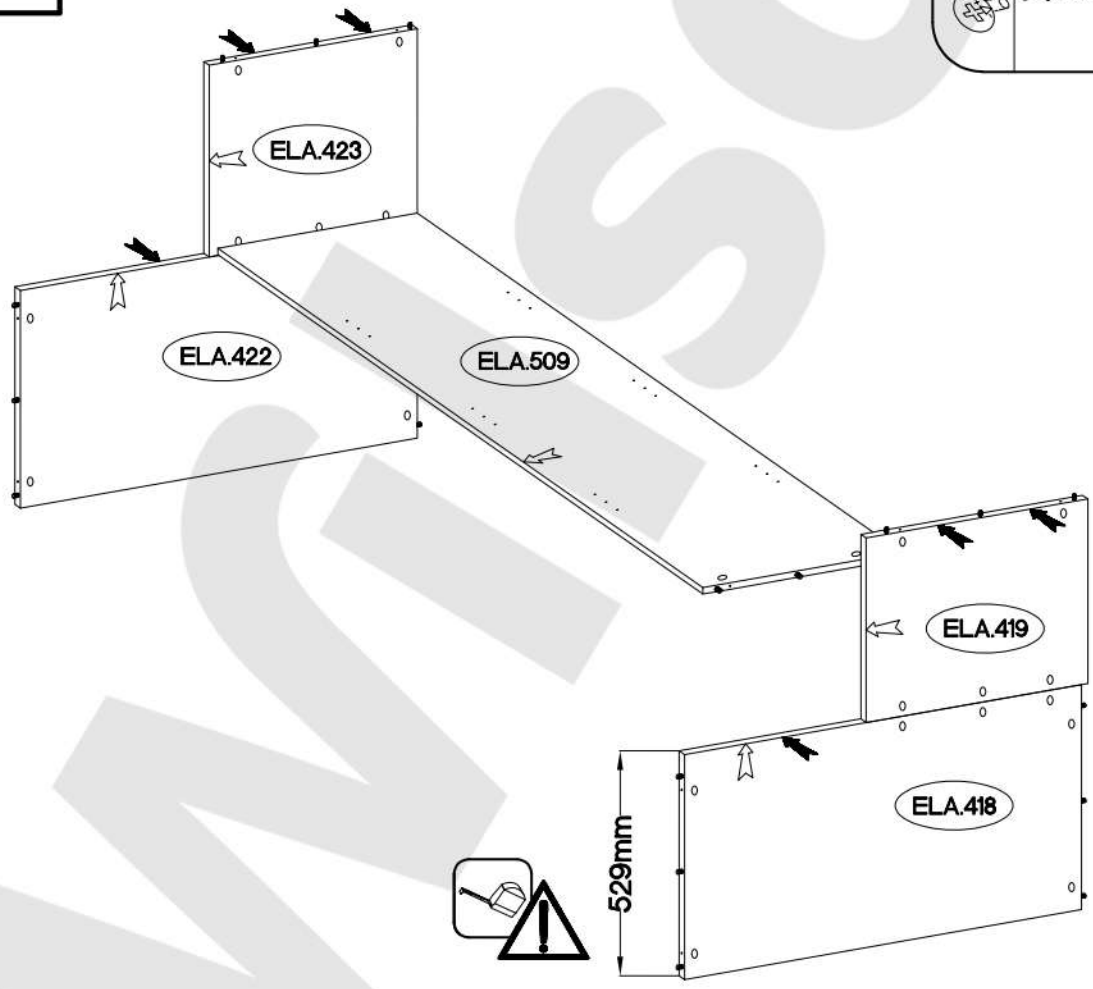

8

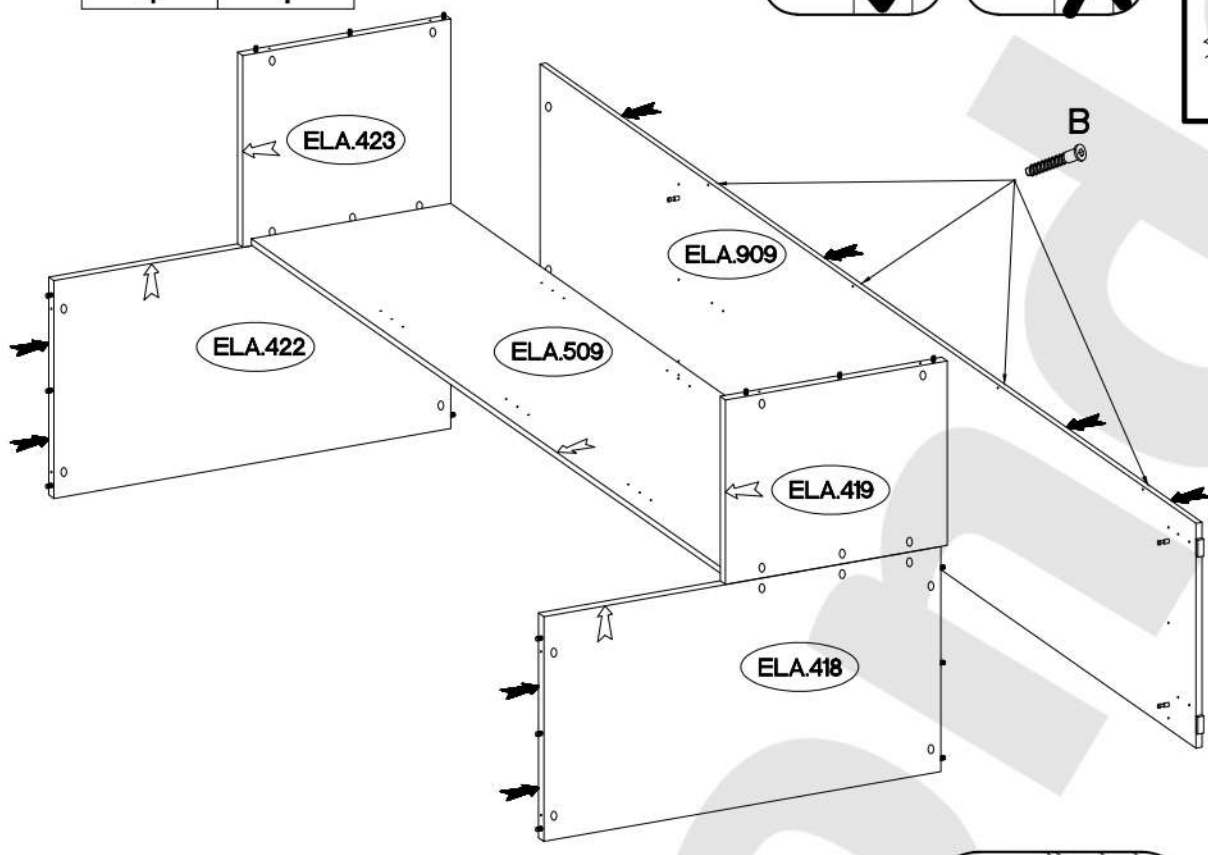
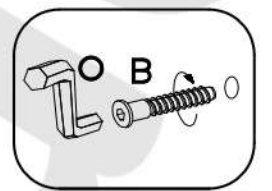
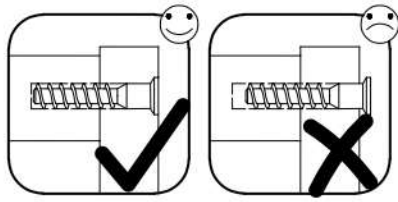
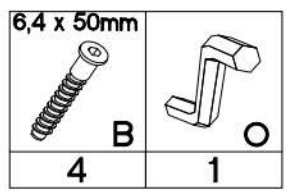

9

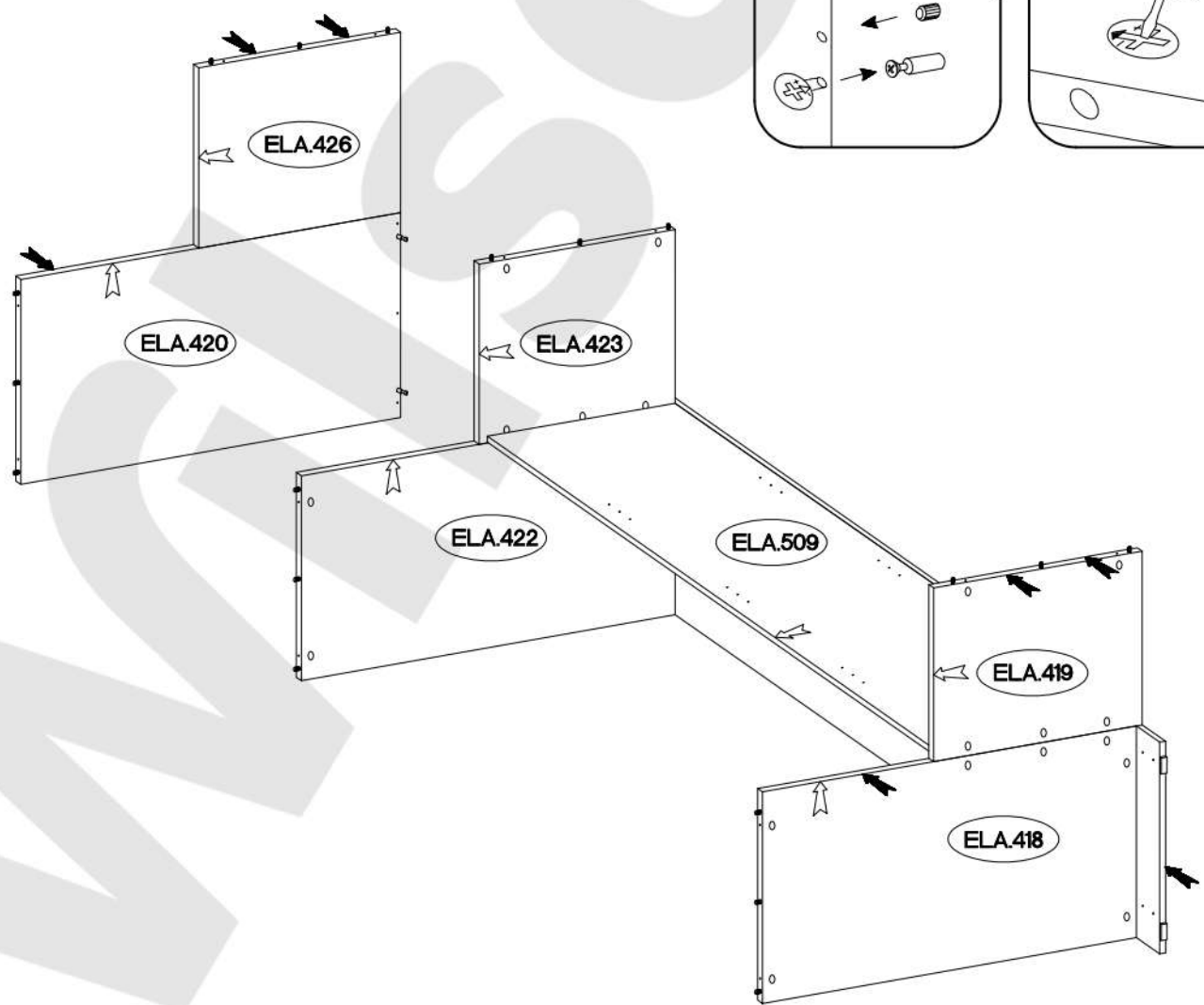
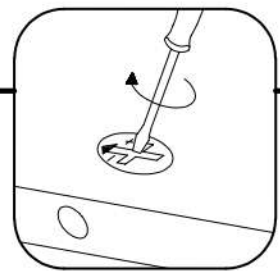
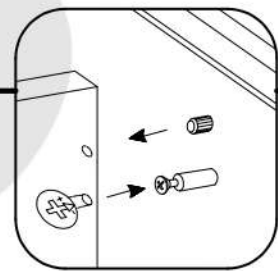

10

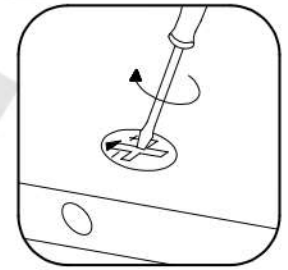
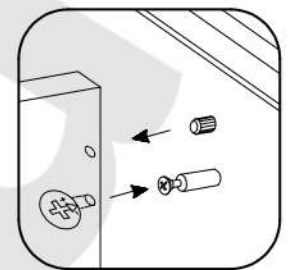
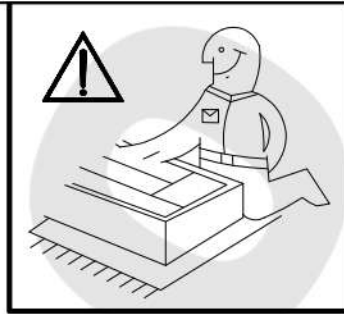
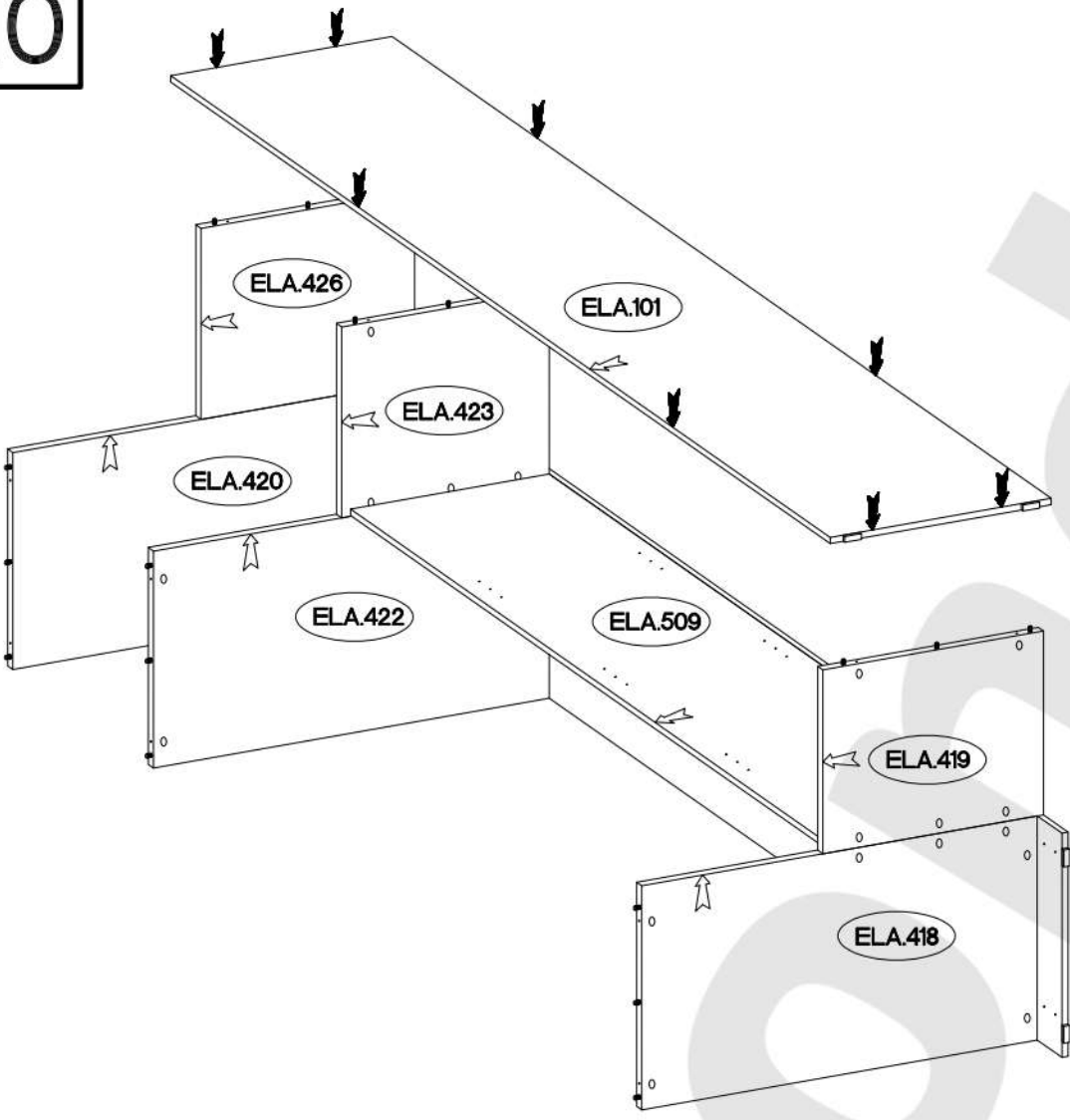

11

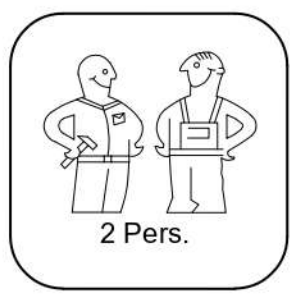
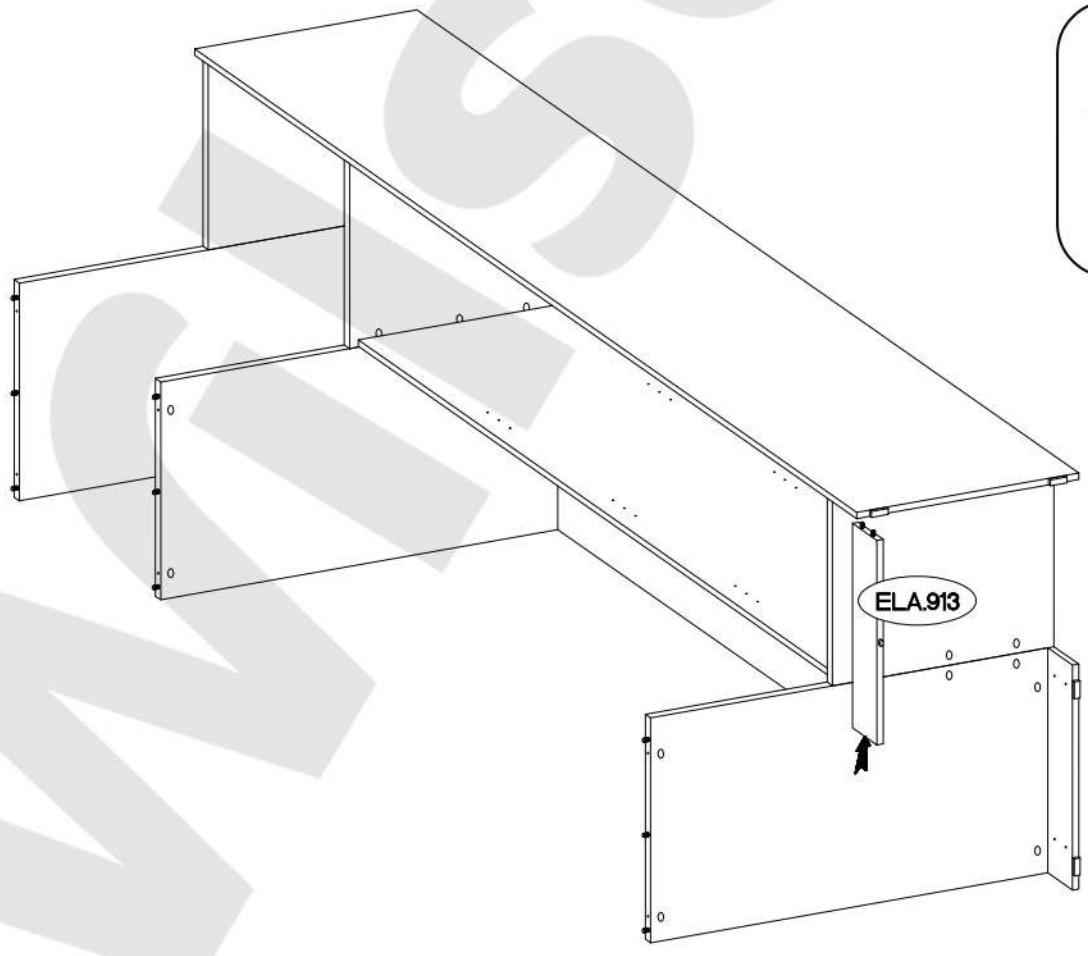

12

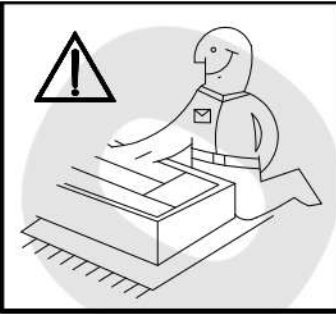
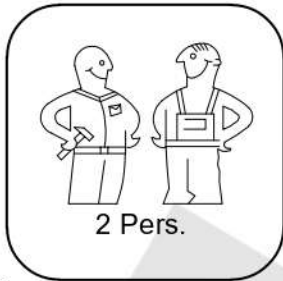
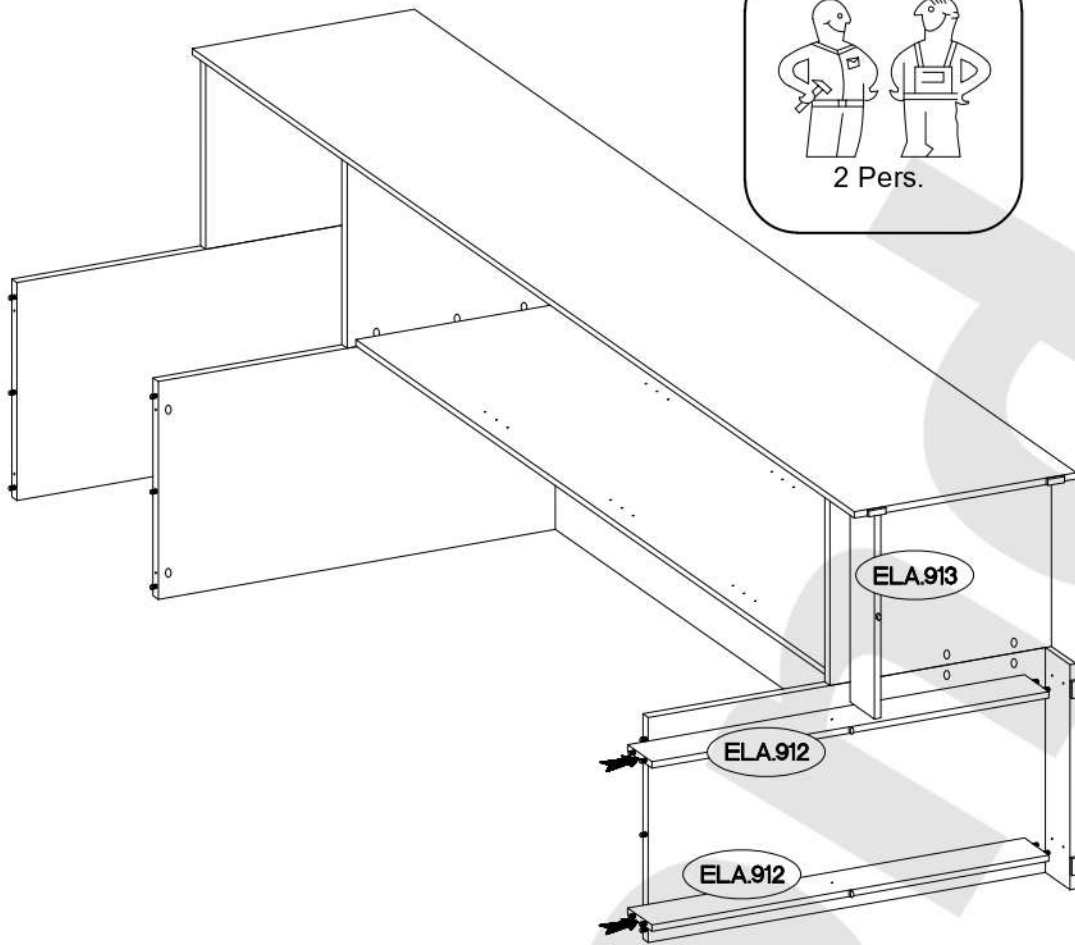

13

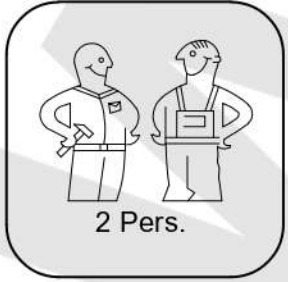
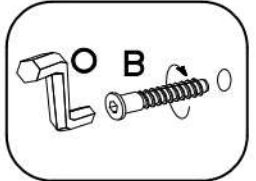
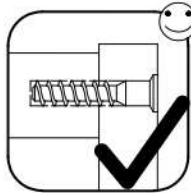
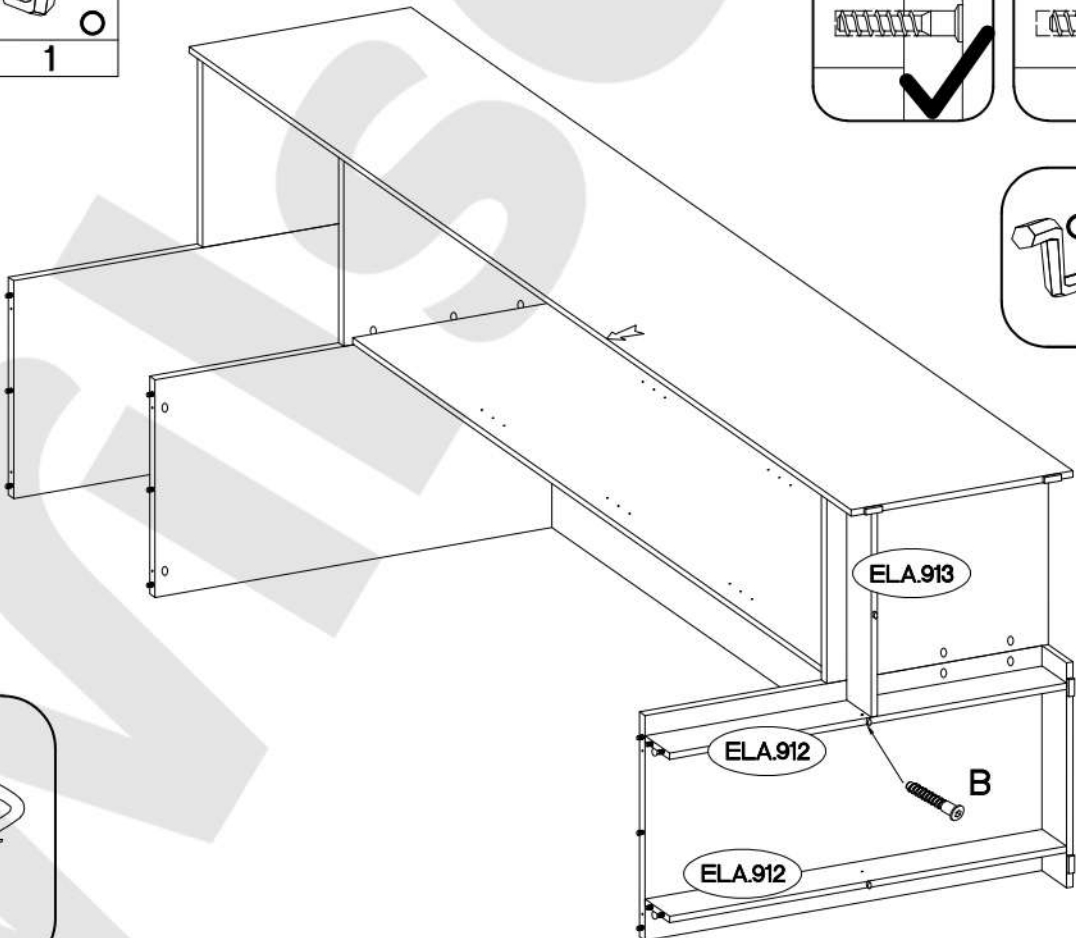
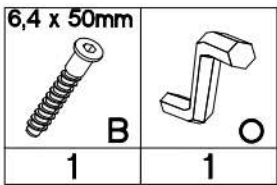

14

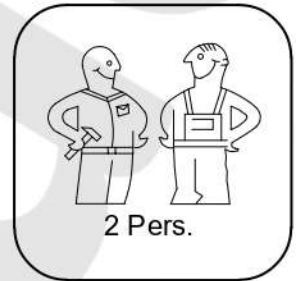
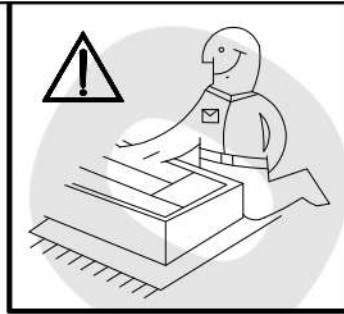
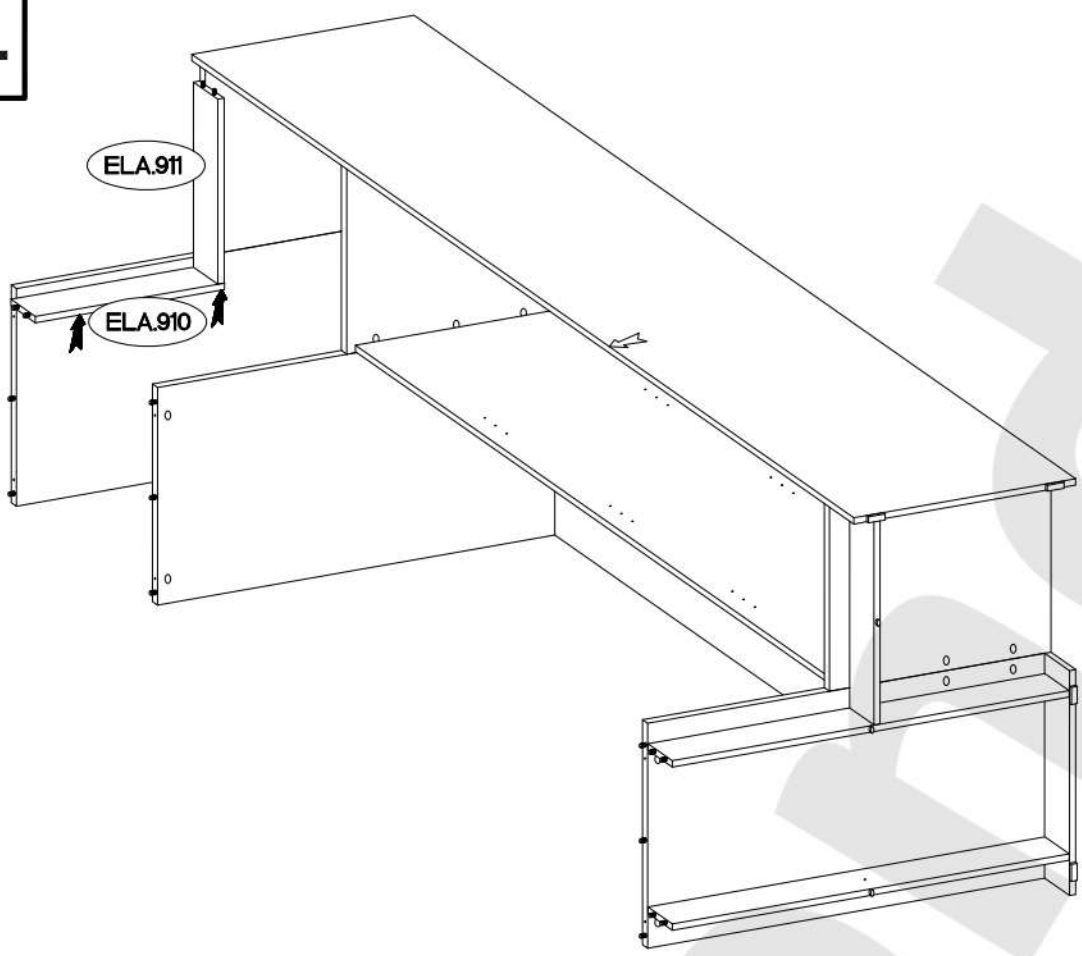

15

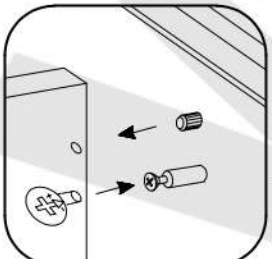
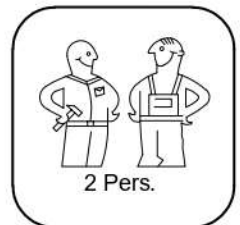
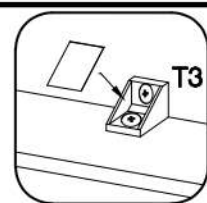
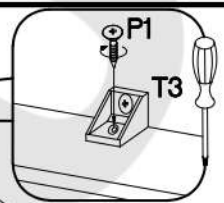
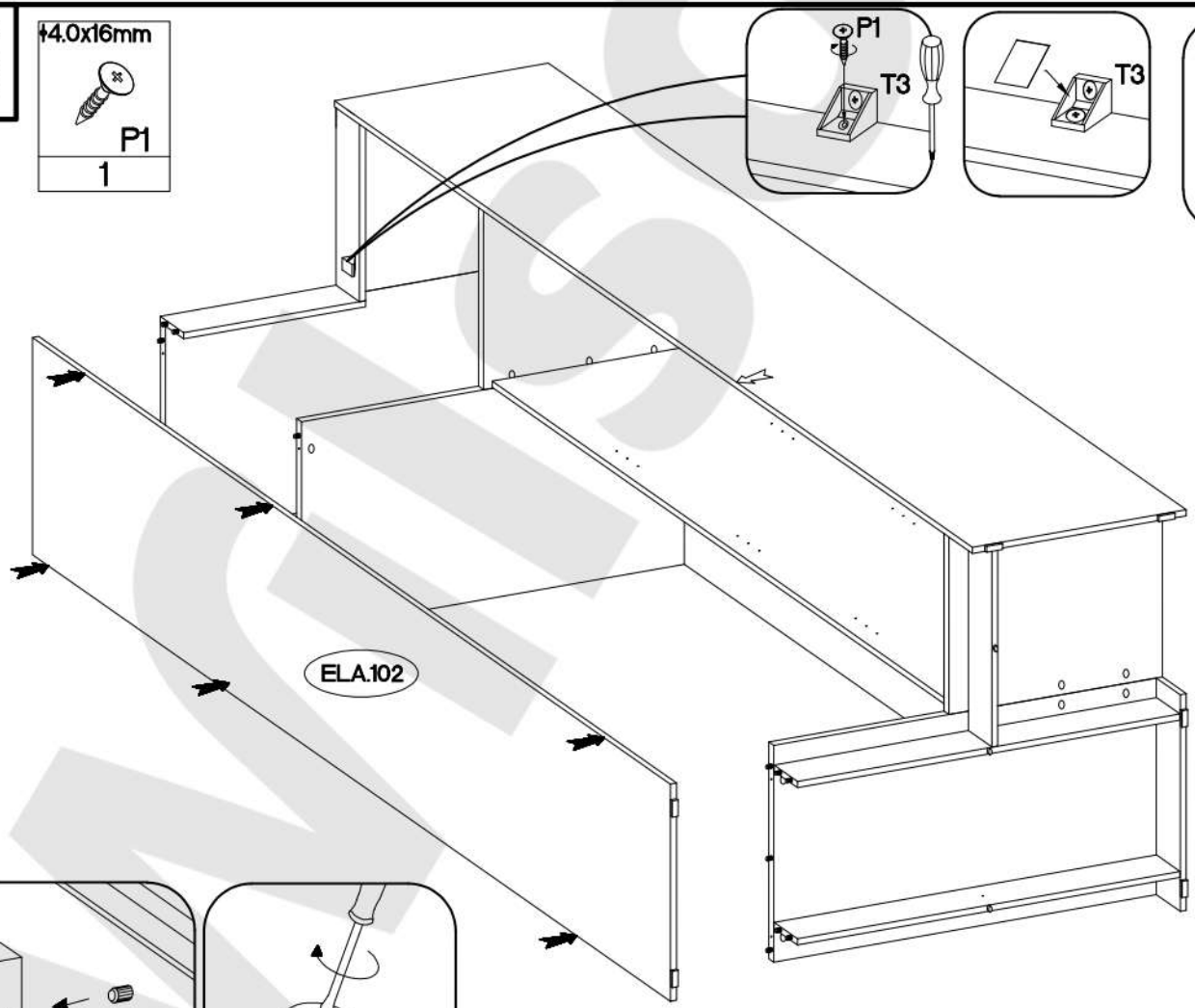



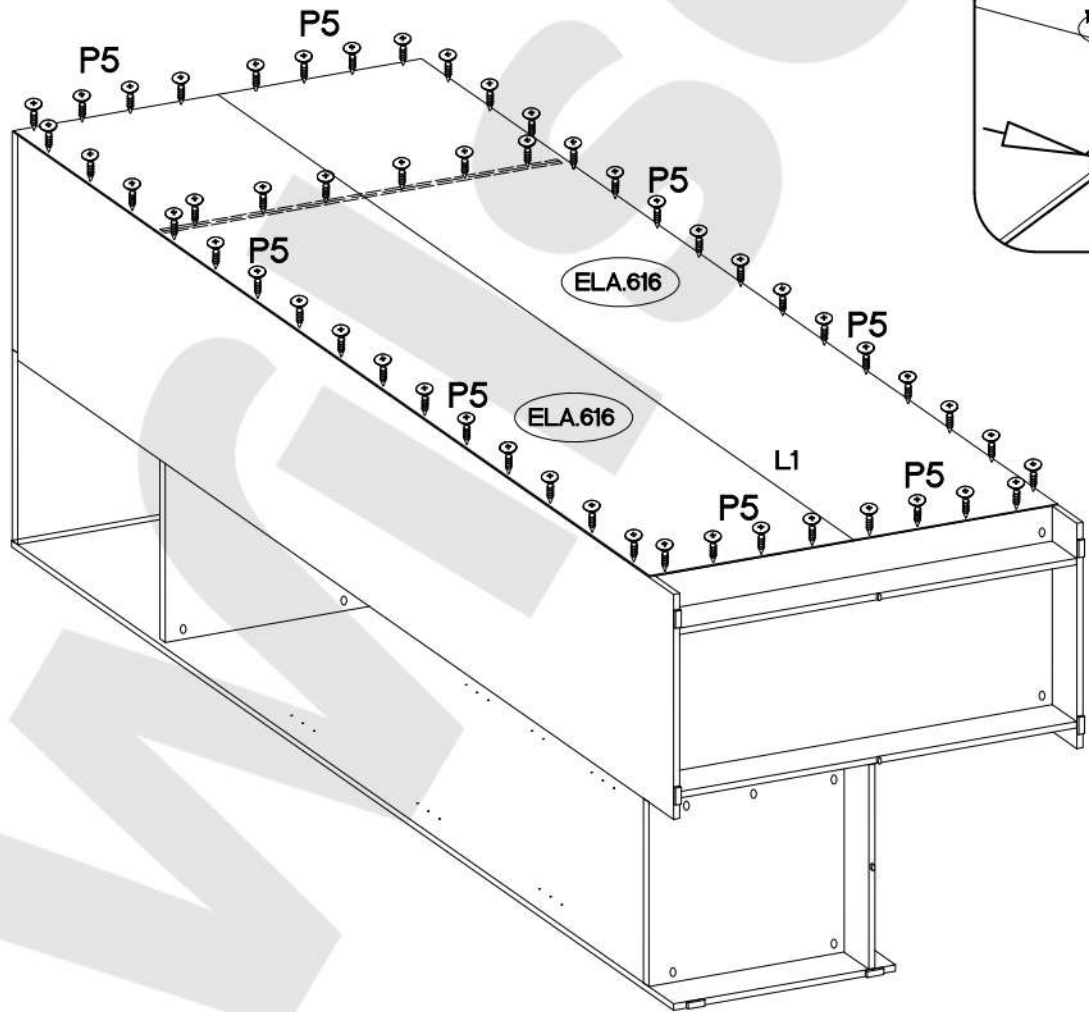
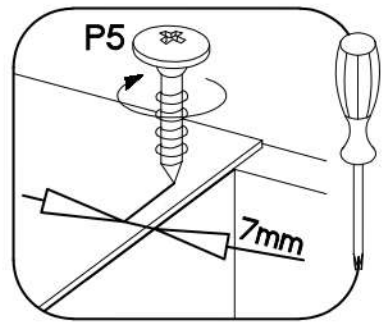
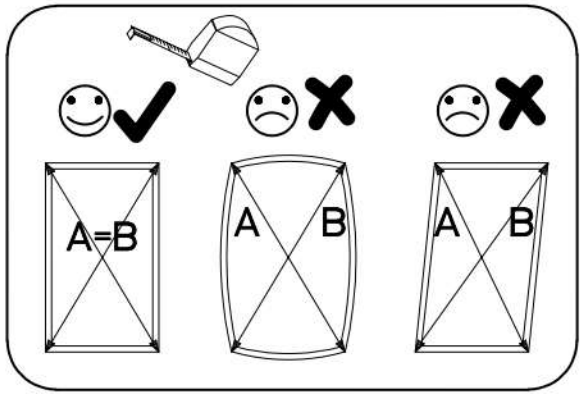
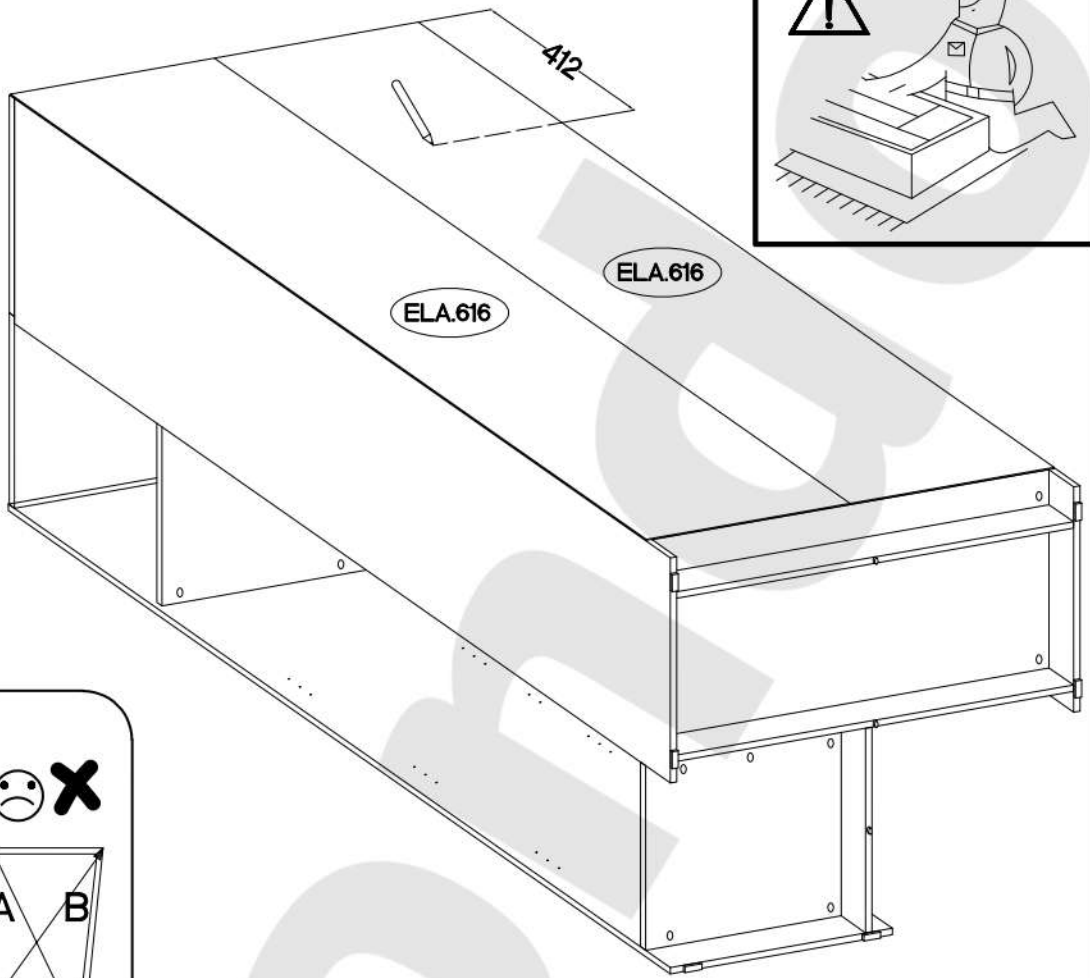
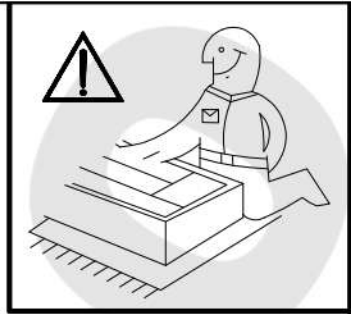

3.5x13mm
P5
55-60

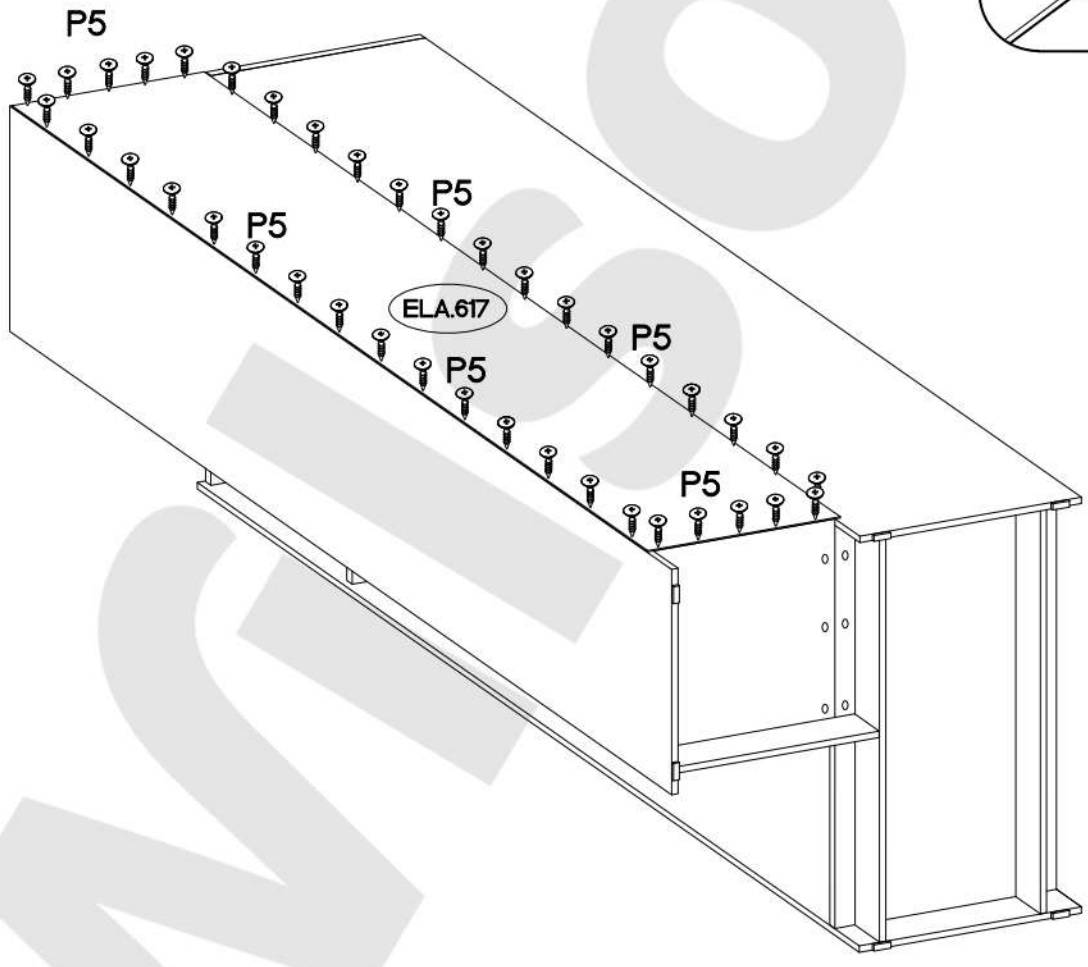
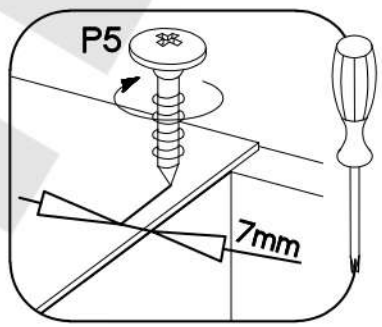
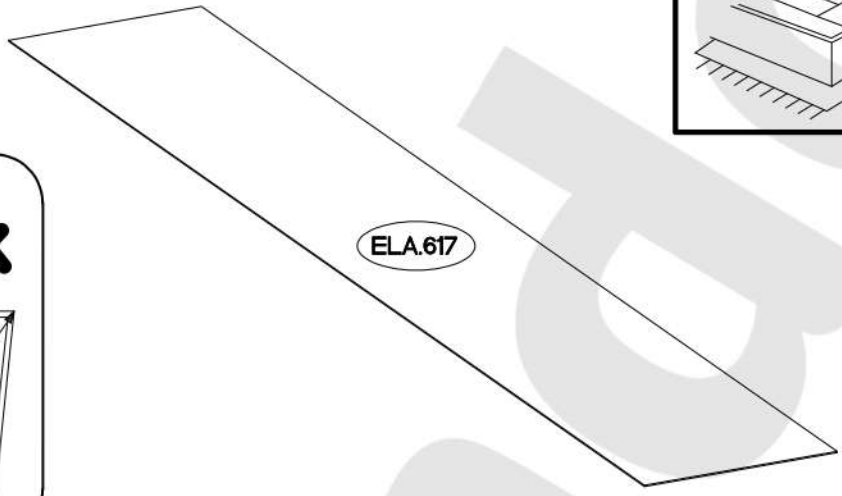
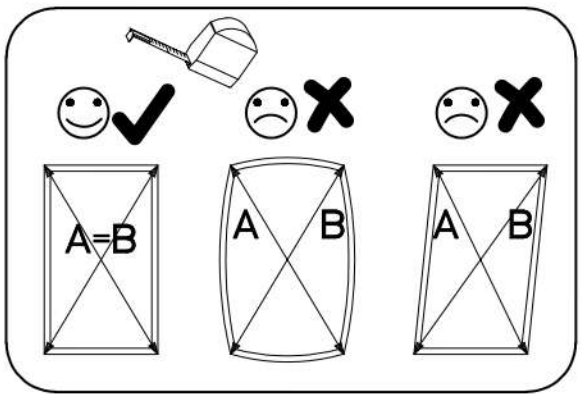
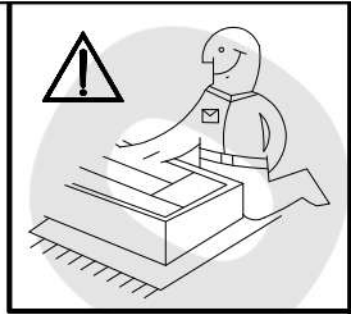





3.5x13mm
P5
45-50

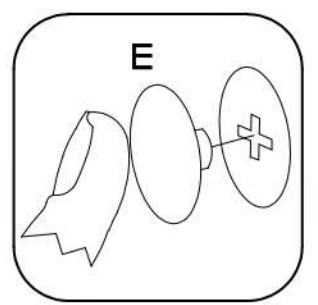
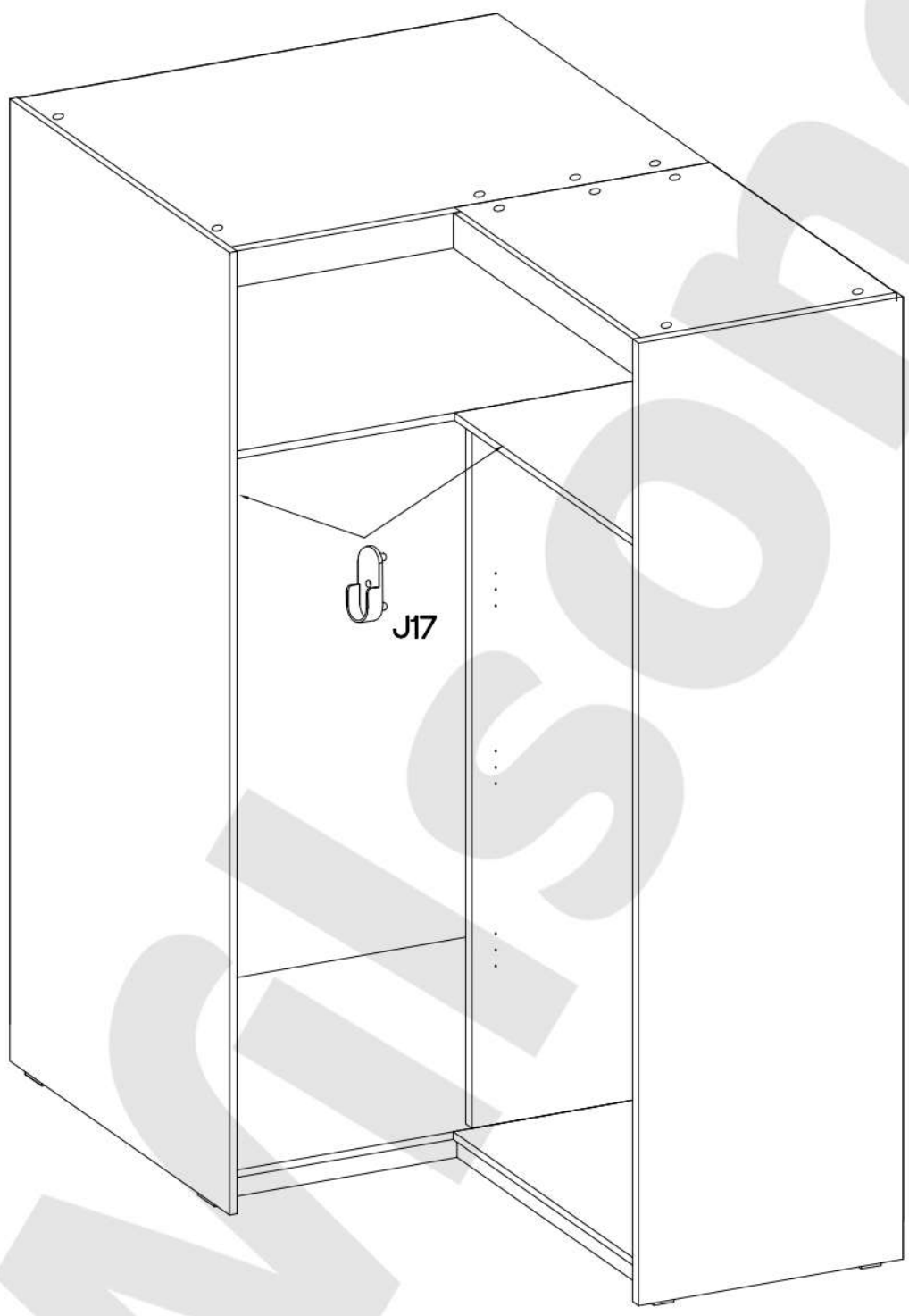
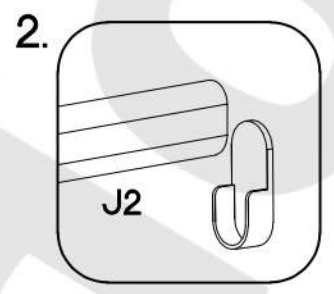
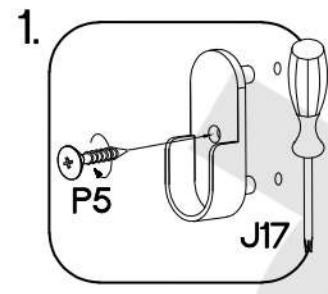

L=940mm  J2 1	 J17 2	φ3.5x13mm  P5 2	 E 15
--	--	--	---



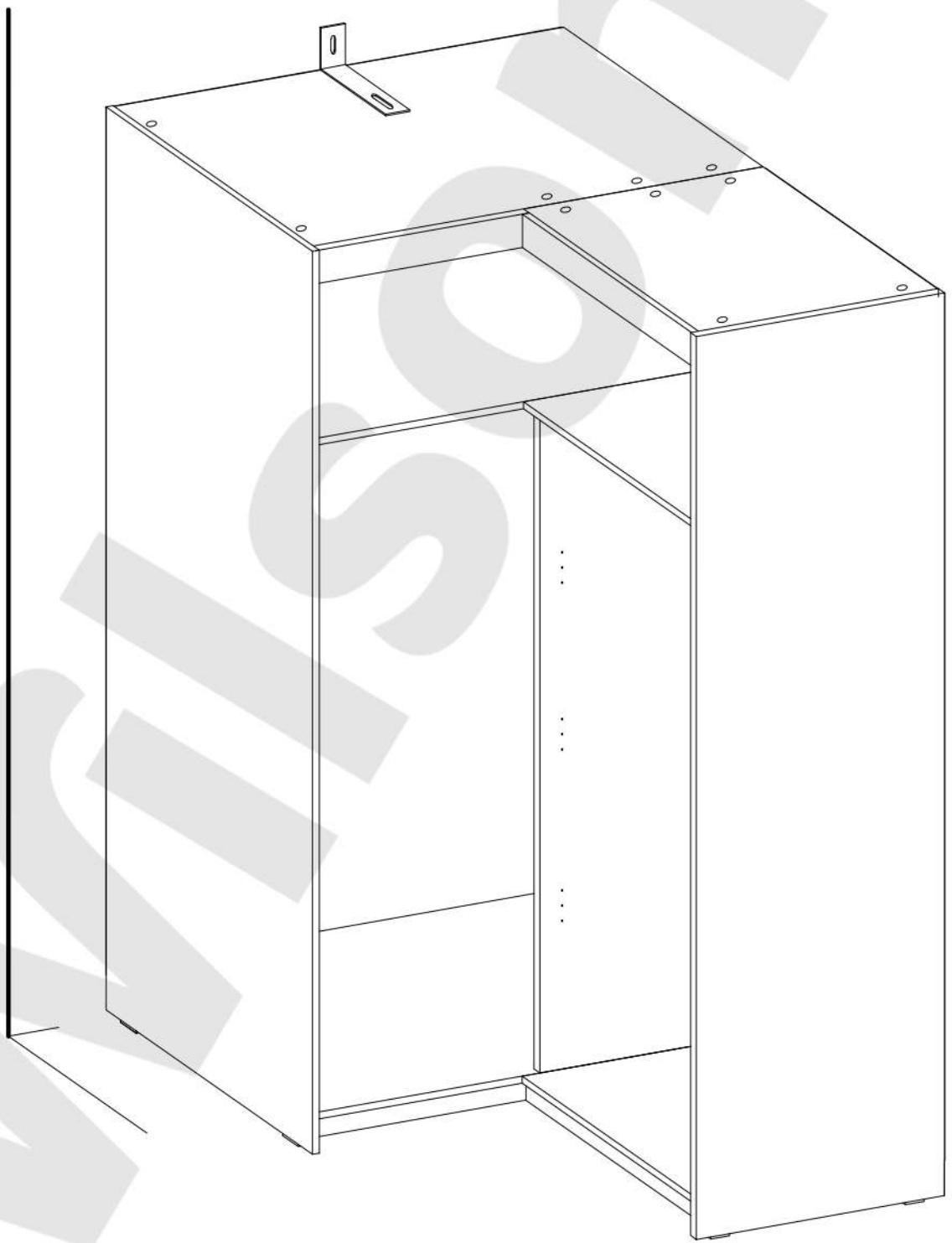
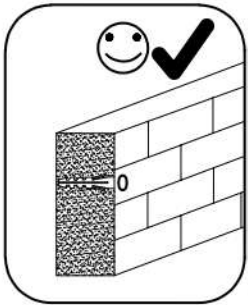
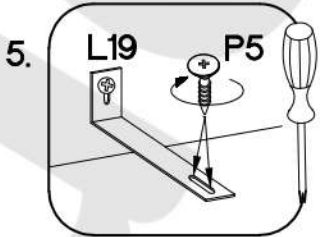
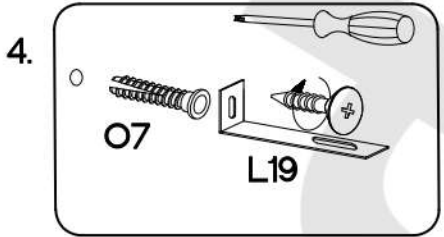
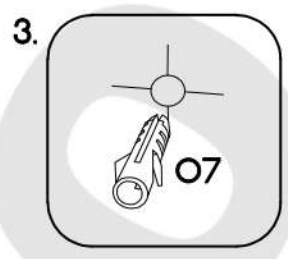
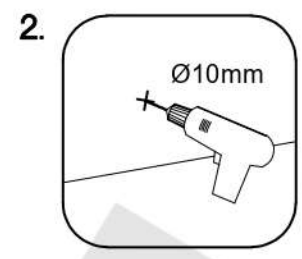
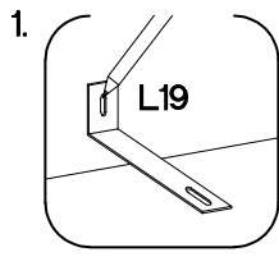

			
L19	P5	P12	O7
1	2	1	1



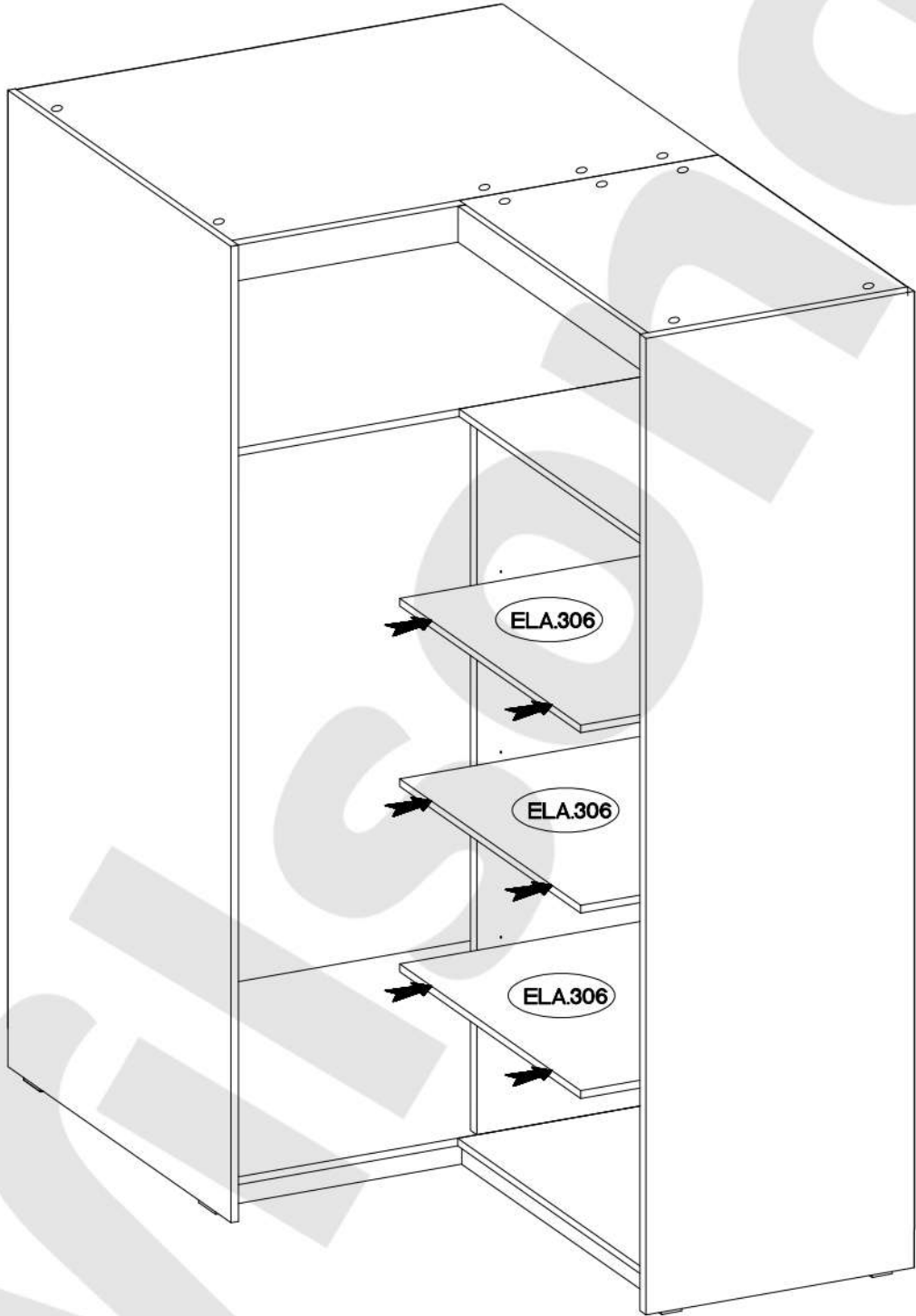
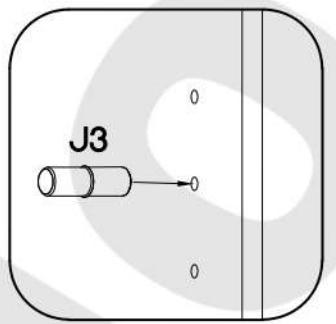

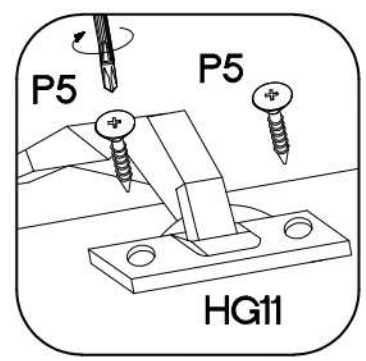
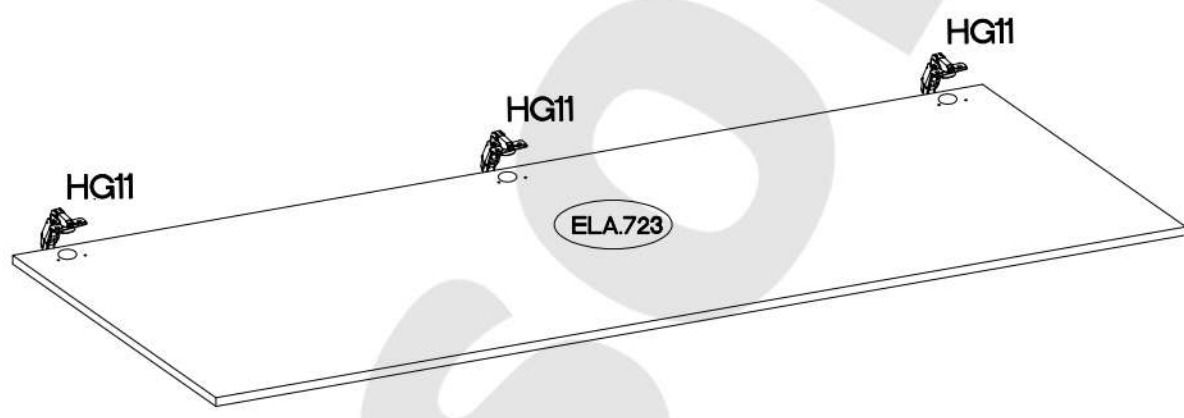
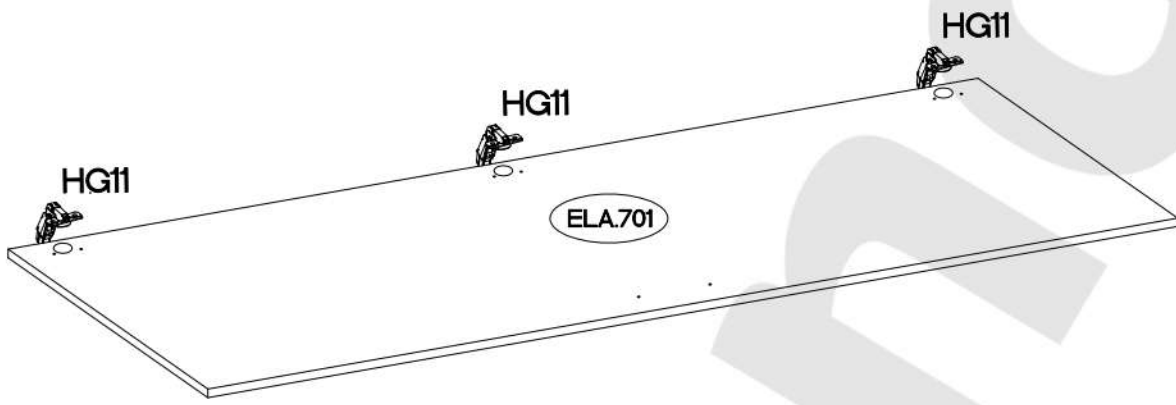
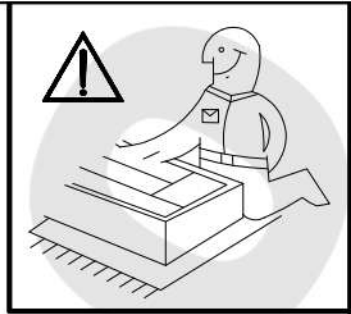

±5/16mm

J3
12

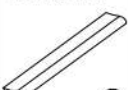

 HG11	 P5
6	12



L=128mm	±4.0x30mm	±6.3x30mm	H=16mm
			
S	R2	M11	J59
1	2	12	6

