

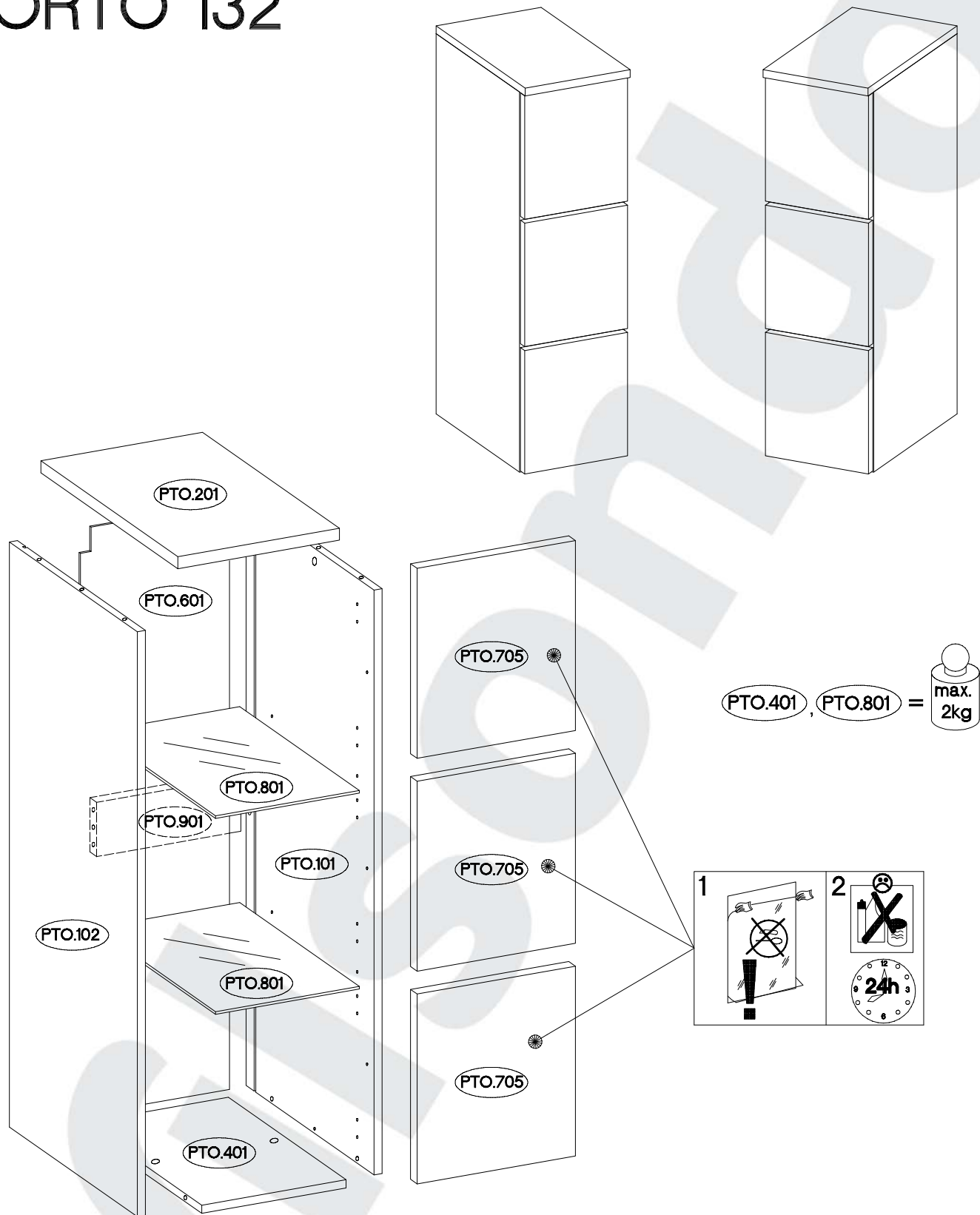

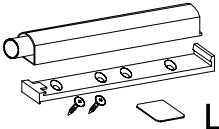

















PORTO 132



			
L23	J12	P7	E
3	8	3	4

									
D2	C	A	L	O1	K	P8	H	G	P5
6	6	12	4	1	2	4	6	6	12

1

L=20mm  D2	#5/12mm  C	#8x30mm  A	 K	#4.0x30mm  P8	 O1
6	6	12	2	4	1

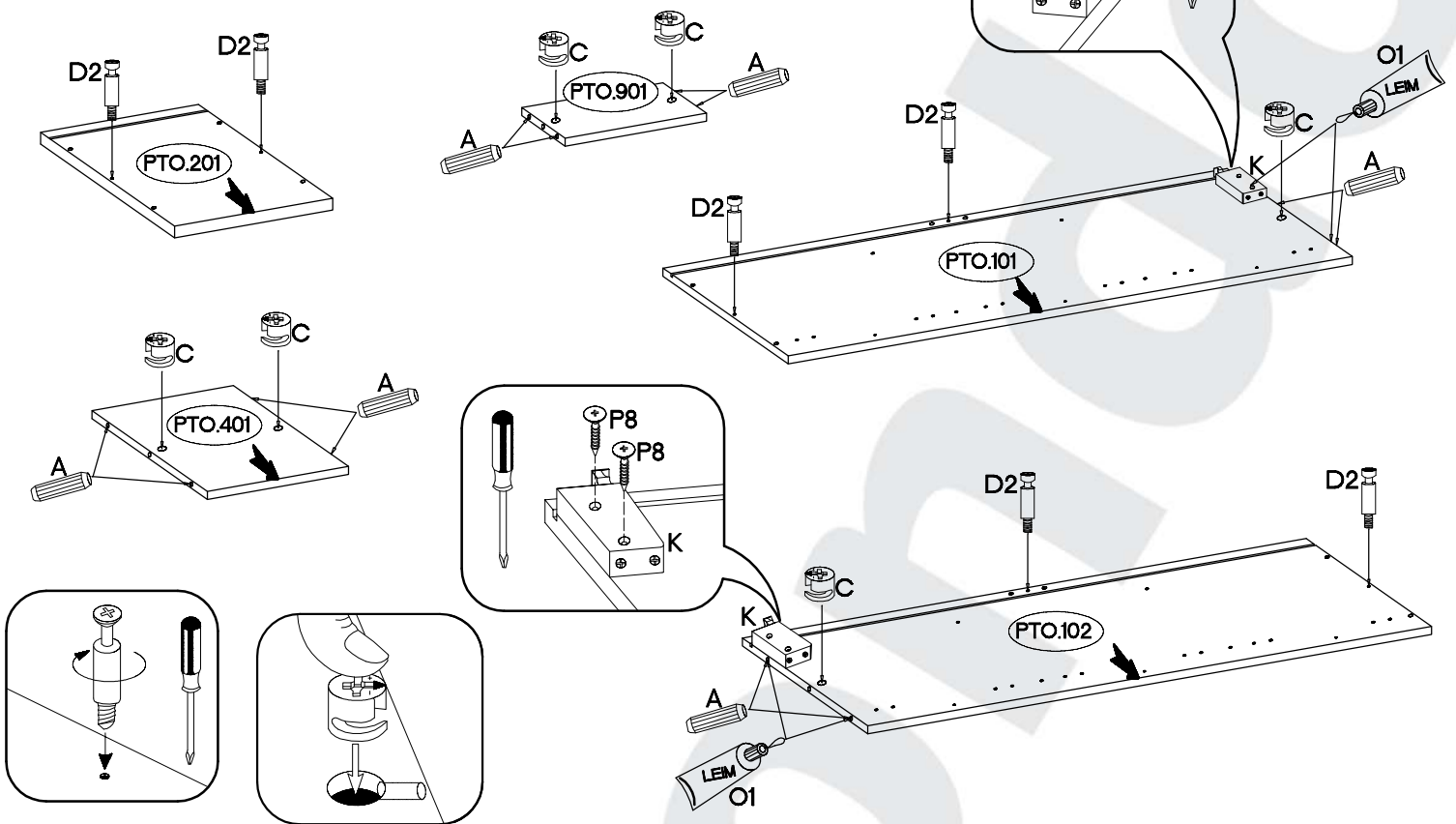

2

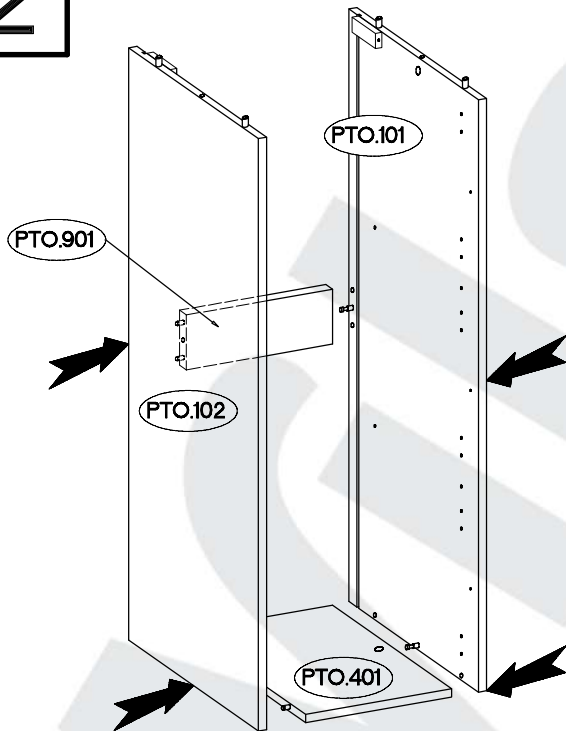

3

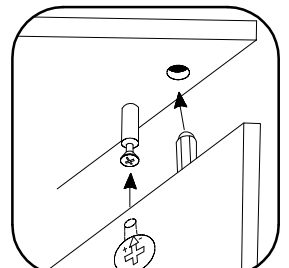
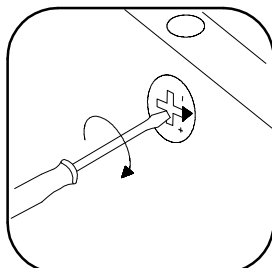
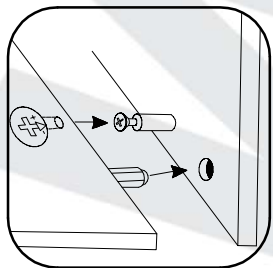
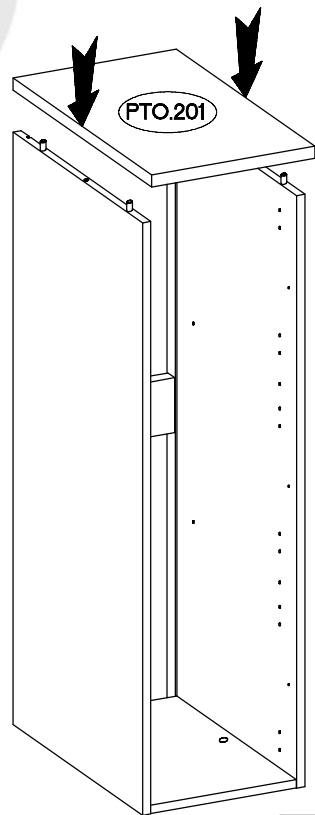

4

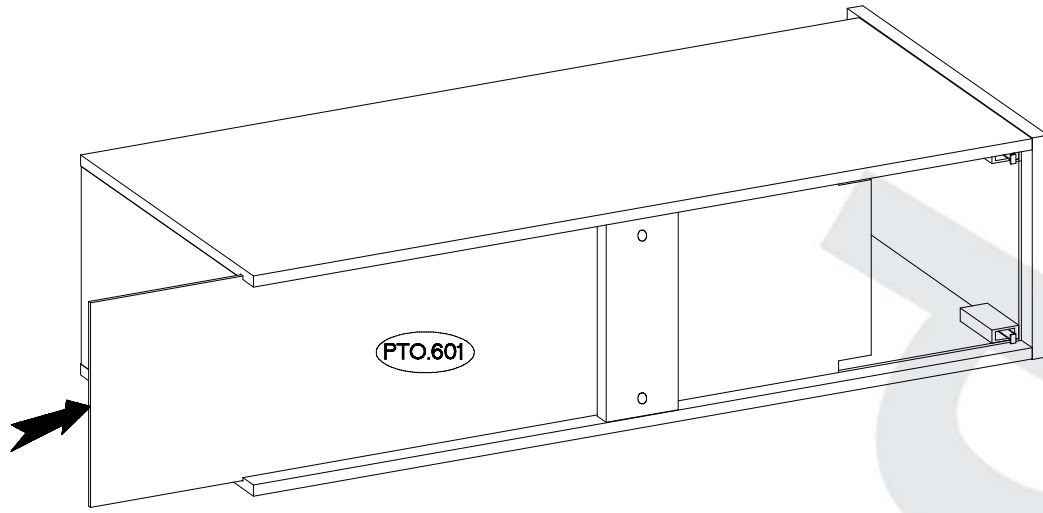

5

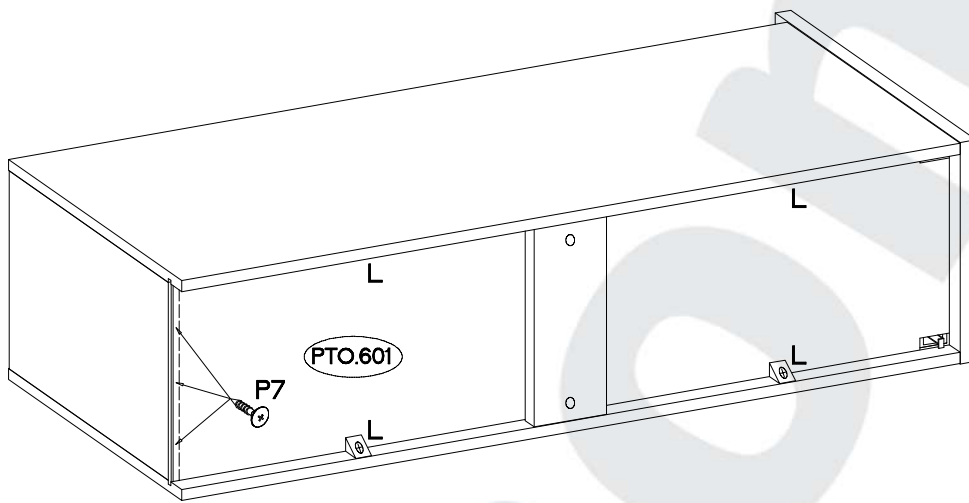

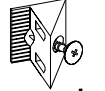
	+3.0x20mm
L	P7
4	3

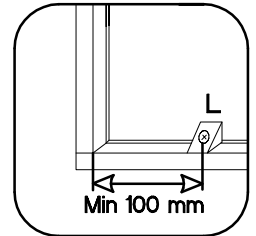
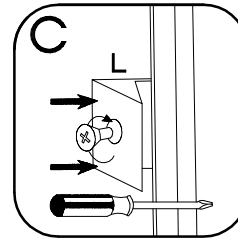
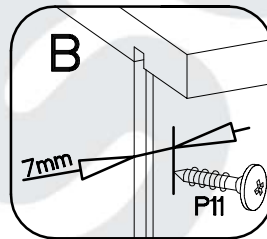
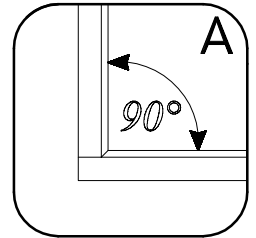

6

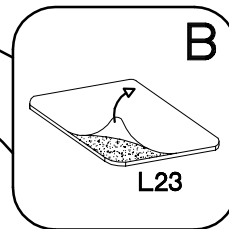
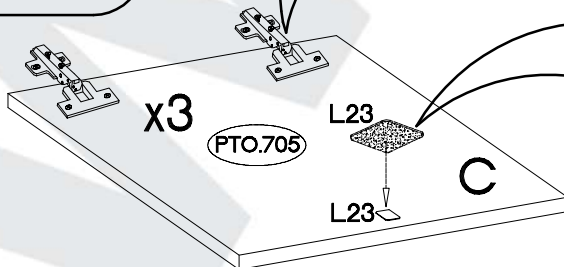
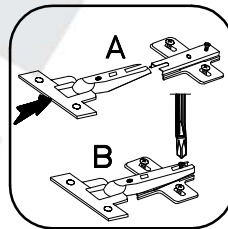
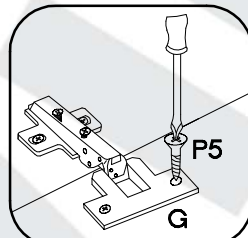
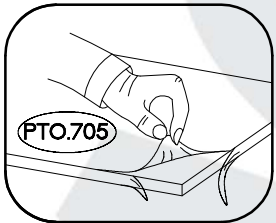

H=0	+35/0mm	+3.5x13mm
H	G	P5
6	6	12

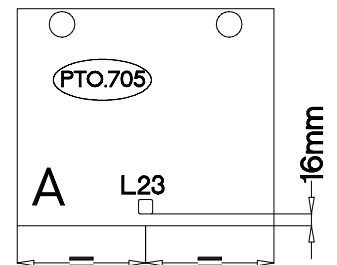
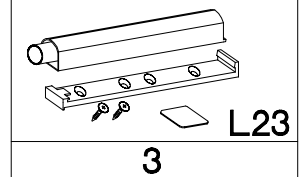

7

