

SENSO D

ca. 2h 

- PL Instrukcja montażu
- D Montageanleitung
- NL Handleiding voor de montage
- TR Montaj talimatı
- F Notice de montage
- CZ Montážní návod
- HU Szerelési útmutató
- GB Assembly instructions
- RU Инструкция по монтажу
- IT Istruzioni di montaggio
- SK Návod na montáž
- RO Instrucțiuni de montaj
- ES Instrucciones de montaje

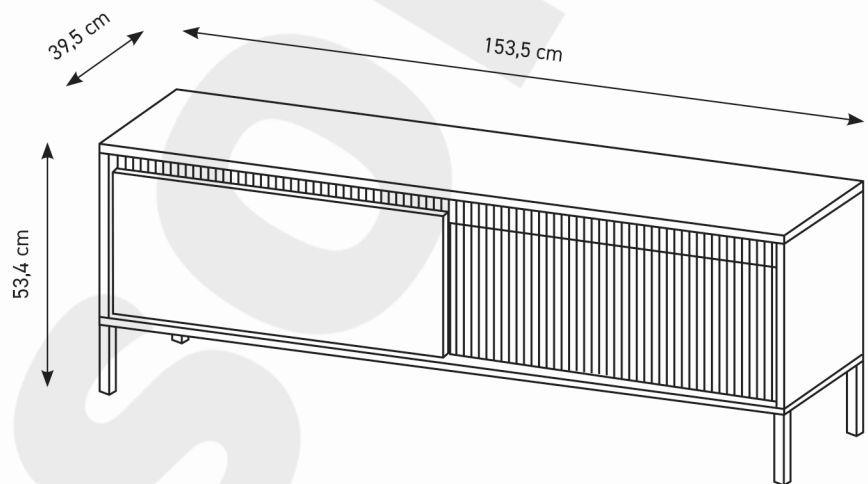

2023-11-23

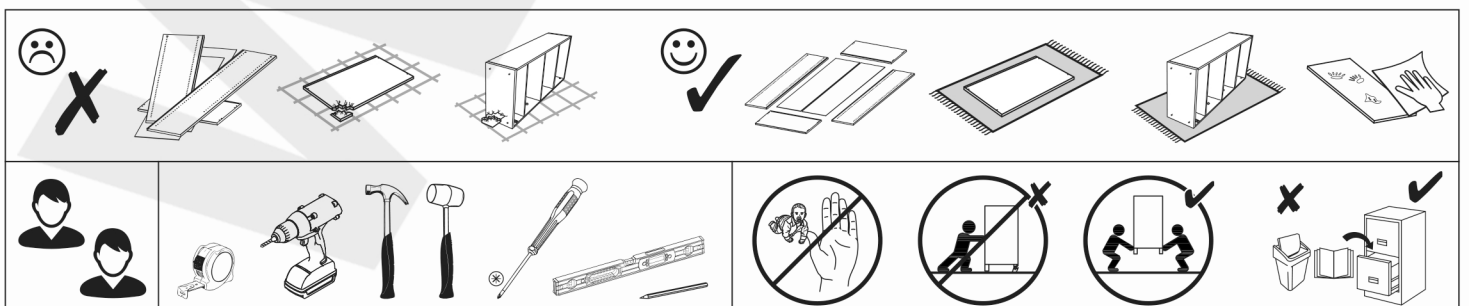

SENSO D

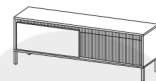

PL Przed rozpoczęciem montażu mebla wszystkie elementy należy sprawdzić czy nie są uszkodzone. W przypadku wykrycia uszkodzenia elementu należy odstąpić od montażu mebla i złożyć reklamację. Montaż produktu w oparciu o uszkodzone elementy oznacza akceptację ich stanu przez Kupującego, co powoduje, że reklamacja uszkodzonych elementów nie będzie uznawana.

Nie wolno przekraczać podanych maksymalnych wartości obciążenia. W innym przypadku można mebel uszkodzić lub zniszczyć.

Przed zawieszeniem mebla, lub przymocowaniem go do ściany (w celu zabezpieczenia przed przewróceniem), sprawdź wcześniej rodzaj i wytrzymałość ściany. Wybierz odpowiednie kotki i wkręty do rodzaju ściany. W przypadku wątpliwości skontaktuj się ze specjalistą. Montaż musi zostać wykonany przez osobę kompetentną.

D Vor Beginn der Möbelmontage sollten alle Elemente auf Beschädigungen überprüft werden. Wenn ein Element des Produkts beschädigt ist, installieren Sie das Produkt bitte nicht und reichen Sie eine Beschwerde ein. Die Installation des Produkts auf der Grundlage der beschädigten Elemente bedeutet, dass der Käufer seinen Zustand akzeptiert, was bedeutet, dass die Beschwerde über beschädigte Elemente nicht akzeptiert wird.

Überschritten Sie die angegebenen Maximalbelastungen nicht. Andernfalls kann das Möbelstück beschädigt oder zerstört werden.

Bevor Sie ein Möbelstück an einer Wand aufhängen oder befestigen (um es gegen Umkippen zu sichern), prüfen Sie Art und Tragfähigkeit der Wand. Wählen Sie die für die Wand geeigneten Dübel und Schrauben. Im Zweifelsfall kontaktieren Sie bitte einen Fachmann. Die Montage muss durch eine sachkundige Person ausgeführt werden.

F Avant de commencer l'assemblage du meuble, tous les éléments doivent être vérifiés pour déceler tout dommage. Si un élément du produit est endommagé, veuillez ne pas installer le produit et déposer une plainte. L'installation du produit sur la base des éléments endommagés signifie que l'Acheteur accepte leur état, ce qui signifie que la réclamation d'éléments endommagés ne sera pas acceptée.

Ne dépassez pas les charges maximum indiquées. Sinon, le meuble peut être endommagé ou détruit. Avant de suspendre le meuble ou de le fixer au mur (dans le but d'éviter un renversement), vérifiez au préalable le type et la résistance du mur. Utilisez les chevilles et les vis adaptées au type de mur. En cas de doute, veuillez contacter un spécialiste. Le montage doit être réalisé par une personne compétente.

CZ Před zahájením montáže nábytku je třeba zkontrolovat poškození všech prvků. Pokud je některý prvek produktu poškozen, zdržte se instalace produktu a podejte stížnost. Instalace výrobku na základě poškozených prvků znamená, že kupující akceptuje jejich stav, což znamená, že reklamacie poškozených prvků nebude uznána.

Nepřekračujte uvedené maximální zatížení. V opačném případě může dojít k poškození nebo zničení nábytku. Před zavěšením nábytku nebo jeho připevněním ke zdi (za účelem zajištění před převrácením) dříve zkontrolujte druh a odolnost stěny. Vyberte k druhu stěny vhodné hmoždinky a šrouby. V případě pochybností kontaktujte specialistu. Montáž musí být provedena kompetentní osobou.

HU A bútor szerelés megkezdése előtt ellenőrizni kell az összes elem sérülését. Ha a termék bármely eleme megsérült, kérjük, tartózkodjon a termék telepítésétől és nyújtson be panaszt. A termék sérült elemek alapján történő felszerelése azt jelenti, hogy a Vevő elfogadja azok állapotát, ami azt jelenti, hogy a sérült elemek igényét nem fogadják el.

A megadott maximális terhelési értékek nem szabad túllépni. Ellenkező esetben a bútor megsérülhet vagy megsemmisülhet. A bútor felüggesztése illetve falhoz való rögzítése (megakadályozván ezzel eldőlésének lehetőségét) előtt ellenőrizze a fal fajtáját és szilárdságát. Megfelelő, a falhoz illő tipliket és csavarokat használjon. Ha kétsége támadna, konzultáljon szakemberrel. A felszerelést csakis egy hozzáértő szakember végezheti el.

GB Before starting the furniture assembly, all elements should be checked for damage. If any element of the product is damaged, please refrain from installing the product and file a complaint. Installation of the product on the basis of the damaged elements means the Buyer's acceptance of their condition, which means that the complaint of damaged elements will not be accepted.

The specified maximum load values must not be exceeded. Otherwise, the piece of furniture may be damaged or destroyed.

Before suspending or fixing furniture to the wall (in order to prevent falling over), check the type and strength of the wall. Select wall plugs and screws appropriate for the given type of the wall. In the case of doubts, contact a specialist. The installation must be performed by a competent person.

SK Pred začatím montáže nábytku by sa mali skontrolovať všetky prvky, či nie sú poškodené. Ak je niektorý prvok výrobku poškodený, neinštalujte výrobok a reklamujte ho. Inštalácia produktu na základe poškodených prvkov znamená, že Kupujúci akceptuje ich stav, čo znamená, že reklamácia poškodených prvkov nebude akceptovaná. Uvedené hodnoty maximálneho zataženia nesmú byť prekročené. V opačnom prípade môže dôjsť k poškodeniu alebo zničeniu nábytku.

Pred zavesením nábytku alebo jeho pripavením na stenu (za účelom zaistenia pred prevrátením) predtým skontrolujte druh a odolnosť steny. Vyberte k druhu steny vhodné hmoždinky a skrutky. V prípade pochybností kontaktujte špecialistu. Montáž musí byť vykonaná kompetentnou osobou.

RU Перед началом сборки мебели следует проверить все элементы на предмет повреждений. Если какой-либо элемент продукта поврежден, пожалуйста, воздержитесь от установки продукта и подайте жалобу. Установка товара на поврежденные элементы означает, что Покупатель принимает их состояние, а значит, претензии по поврежденным элементам не принимаются.

Указанные максимальные значения нагрузки не должны превышать. В противном случае предмет мебели может быть поврежден или уничтожен.

Перед подвешиванием мебели или ее креплением к стене (для защиты от падений) проверьте предварительно тип и прочность стены. Подберите соответствующие типу стены дюбели и шурупы. При возникновении сомнений свяжитесь со специалистом. Монтаж должен проводиться компетентным лицом.

IT Prima di iniziare l'assemblaggio del mobile, tutti gli elementi dovrebbero essere controllati per danni. Se qualche elemento del prodotto è danneggiato, astenersi dall'installare il prodotto e presentare un reclamo. L'installazione del prodotto sulla base degli elementi danneggiati implica l'accettazione da parte dell'Acquirente della loro condizione, il che significa che il reclamo per elementi danneggiati non sarà accettato.

I valori di carico massimo specificati non devono essere superati. In caso contrario, il mobile potrebbe essere danneggiato o distrutto.

Prima di appendere i mobili, oppure attaccarli al muro (per proteggerli da ribaltamenti), verifica prima la tipologia e resistenza del muro. Scegli i tasselli e viti più adatti per il tipo di muro. In caso di dubbi contattare uno specialista. Il montaggio deve essere fatto da una persona competente.

NL Voordat u met de meubelmontage begint, moeten alle elementen op schade worden gecontroleerd. Als een onderdeel van het product beschadigd is, installeer het dan niet en dien een klacht in. Installatie van het product op basis van de beschadigde elementen betekent dat de koper hun staat accepteert, wat betekent dat de claim voor beschadigde elementen niet wordt geaccepteerd.

Overschrijd de aangegeven maximale belastingen niet. Anders kan het meubelstuk worden beschadigd of vernield.

Voordat u het meubel ophangt of bevestigt tegen de muur (om het te beschermen tegen omvallen) dient u het type en de duurzaamheid van deze muur na te kijken. Maak gebruik van pluggen en schroeven die geschikt zijn voor het type muur. Neem in geval van twijfels contact op met een specialist. De assemblage dient te worden uitgevoerd door iemand met kennis van zaken.

TR Mobilya montajına başlamadan önce tüm elemanlarda hasar olup olmadığını kontrol edilmelidir. Ürünün herhangi bir parçası hasar görmüşse, lütfen ürünü kurmayın ve şikayette bulunun. Ürünün hasarlı elemanlar bazında montajı, Alıcının durumunu kabul ettiği anlamına gelir, bu da hasarlı elemanlar için talep kabul edilmeyeceği anlamına gelir.

Belirtilen azami yük değerini aşmayınız, aksi takdirde mobilya parçası zarar görebilir veya kullanılamaz hale gelebilir.

Mobilyayı duvara asmadan veya montaj etmeden önce (devrilmesini önlemek için) duvarın türünü ve dayanıklılığını kontrol edin. Duvara uygun dübelleri ve vidaları seçin. Emrin olamamanız durumunda bir uzman ile irtibata geçin. Kurulum yetkilili bir kişi tarafından yapılmalıdır.

RO Înainte de a începe asamblarea mobilierului, toate elementele trebuie verificate pentru a nu se deteriora. Dacă vreun element al produsului este deteriorat, vă rugăm să vă abțineți de la instalarea produsului și să depuneți o reclamație. Instalarea produsului pe baza elementelor deteriorate înseamnă acceptarea de către Cumpărător a stării lor, ceea ce înseamnă că reclamația privind elementele deteriorate nu va fi acceptată.

Valorile maxime de sarcină specificate nu trebuie depășite. În caz contrar, piesa de mobilier poate fi deteriorată sau distrusă.

Înainte de suspendarea unei piese de mobilier sau atașarea acestuia la perete (pentru a preveni bascularea), verificați în prealabil tipul și gradul de rezistență a peretelui. Montați diblurile și șuruburile adecvate pentru tipul de perete. În caz de îndoieli, consultați un specialist. Instalarea trebuie să fie efectuată de către o persoană competentă.

ES Antes de comenzar el montaje de los muebles, todos los elementos deben comprobarse en busca de daños. Si algún elemento del producto está dañado, absténgase de instalar el producto y presente una queja. La instalación del producto sobre la base de los elementos dañados supone la aceptación por parte del Comprador de su estado, por lo que no se aceptará la reclamación de elementos dañados.

No se deben exceder los valores de carga máxima especificados. De lo contrario, el mueble puede dañarse o destruirse.

Antes de colgar o fijar el mueble en el muro (a fin de proteger contra el vuelco del mueble), compruebe de antemano la naturaleza y la resistencia de la pared. Seleccione tacos y tornillos adecuados para el tipo de la pared. En caso de duda, consulte a un especialista, debiendo efectuar este montaje una persona competente.

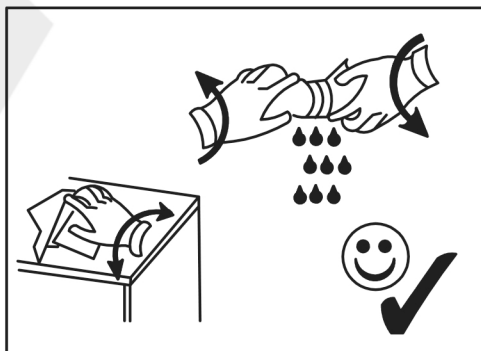
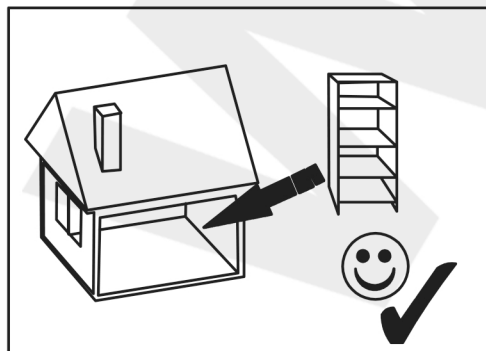
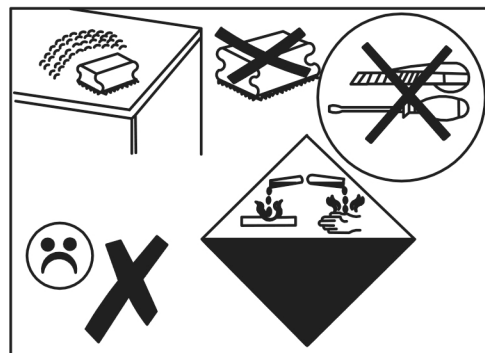
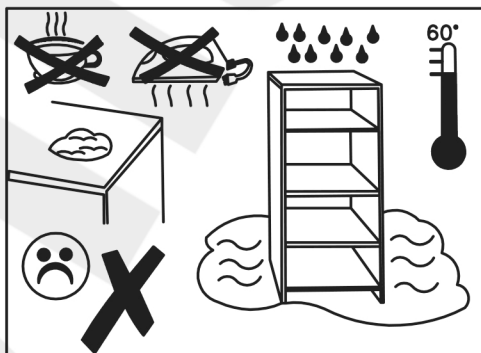
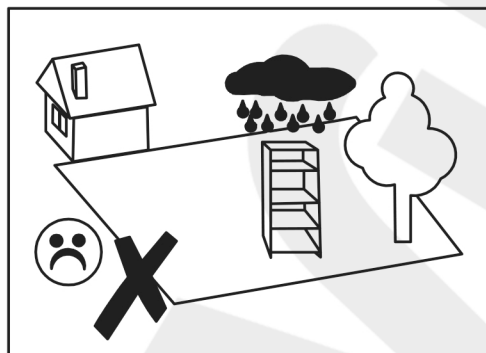

SENSO D

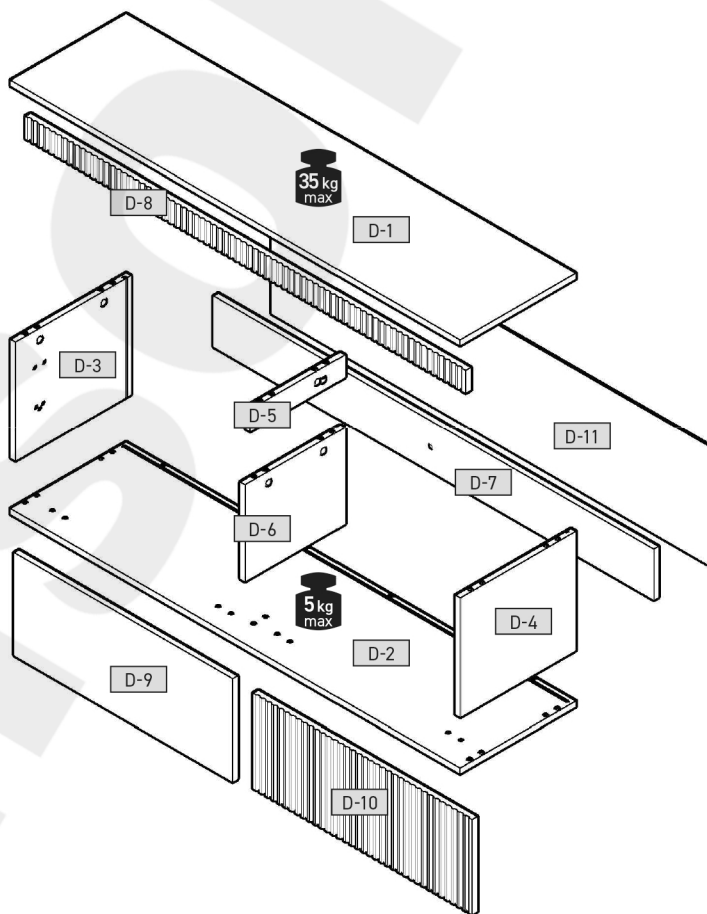
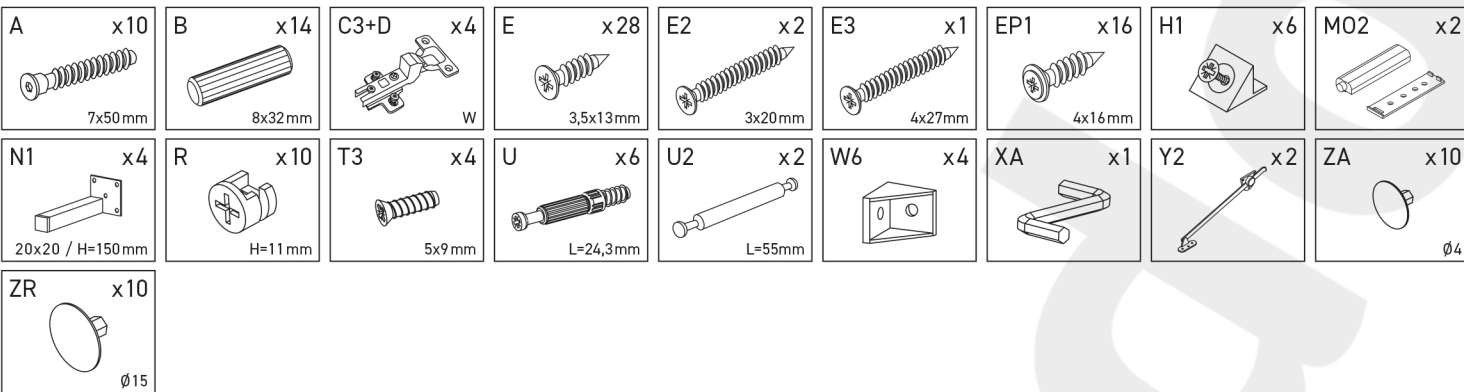
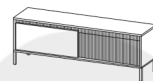

D-1	1535	395	16	x 1	1/1
D-2	1535	395	16	x 1	1/1
D-3	352	394	16	x 1	1/1
D-4	352	394	16	x 1	1/1
D-5	66	322	16	x 1	1/1
D-6	286	340	16	x 1	1/1
D-7	1502	150	16	x 1	1/1
D-8	1502	66	18	x 1	1/1
D-9	740	304	16	x 1	1/1
D-10	752	280	18	x 1	1/1
D-11	1516	366	3	x 1	1/1

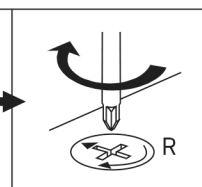
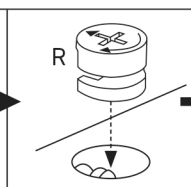
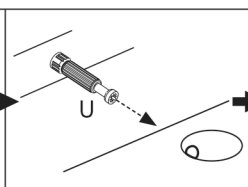
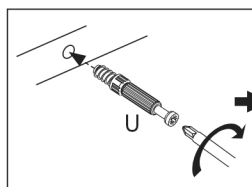
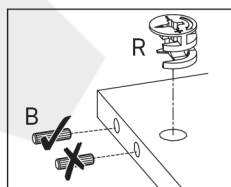
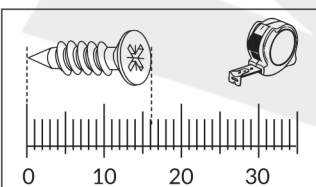

SENSO D

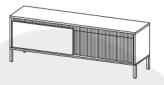

1

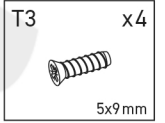
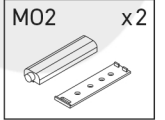
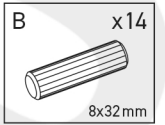
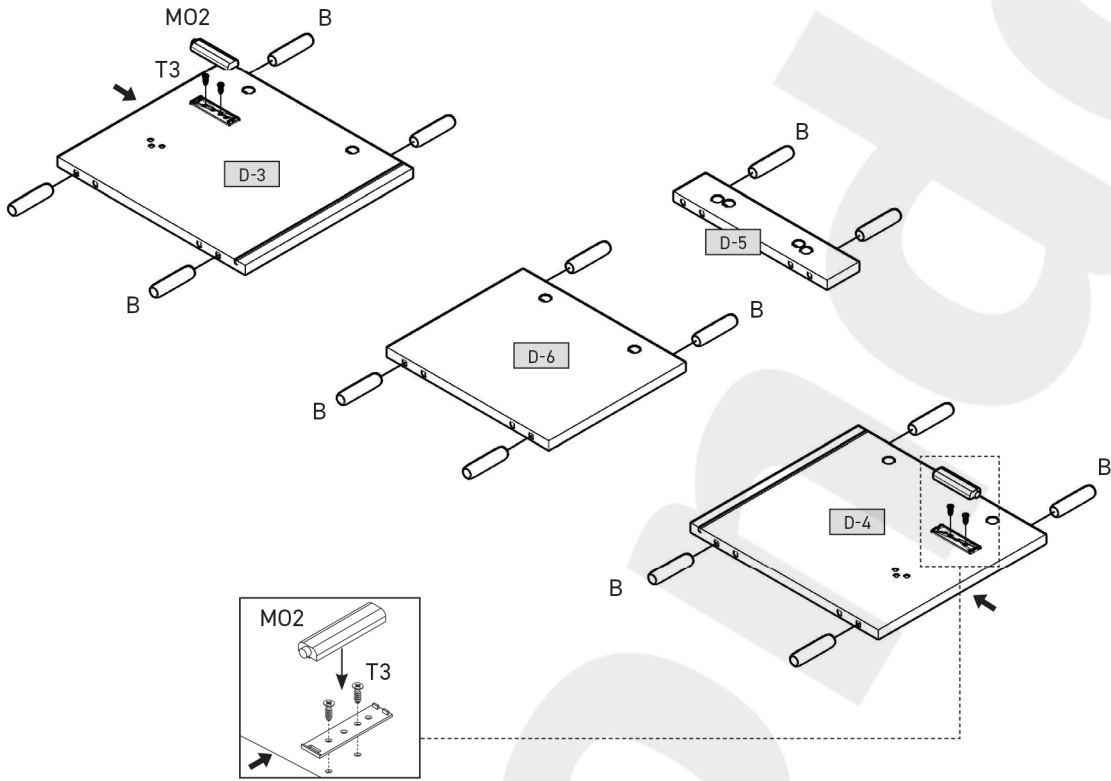

2

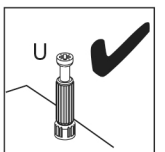
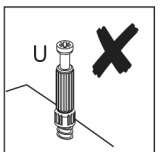
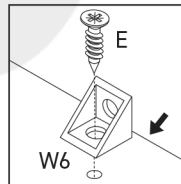
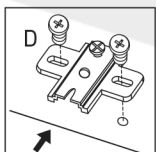
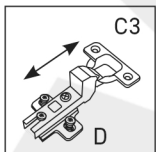
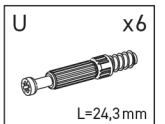
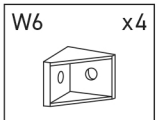
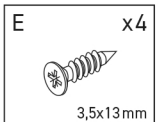
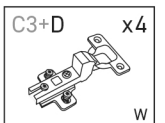
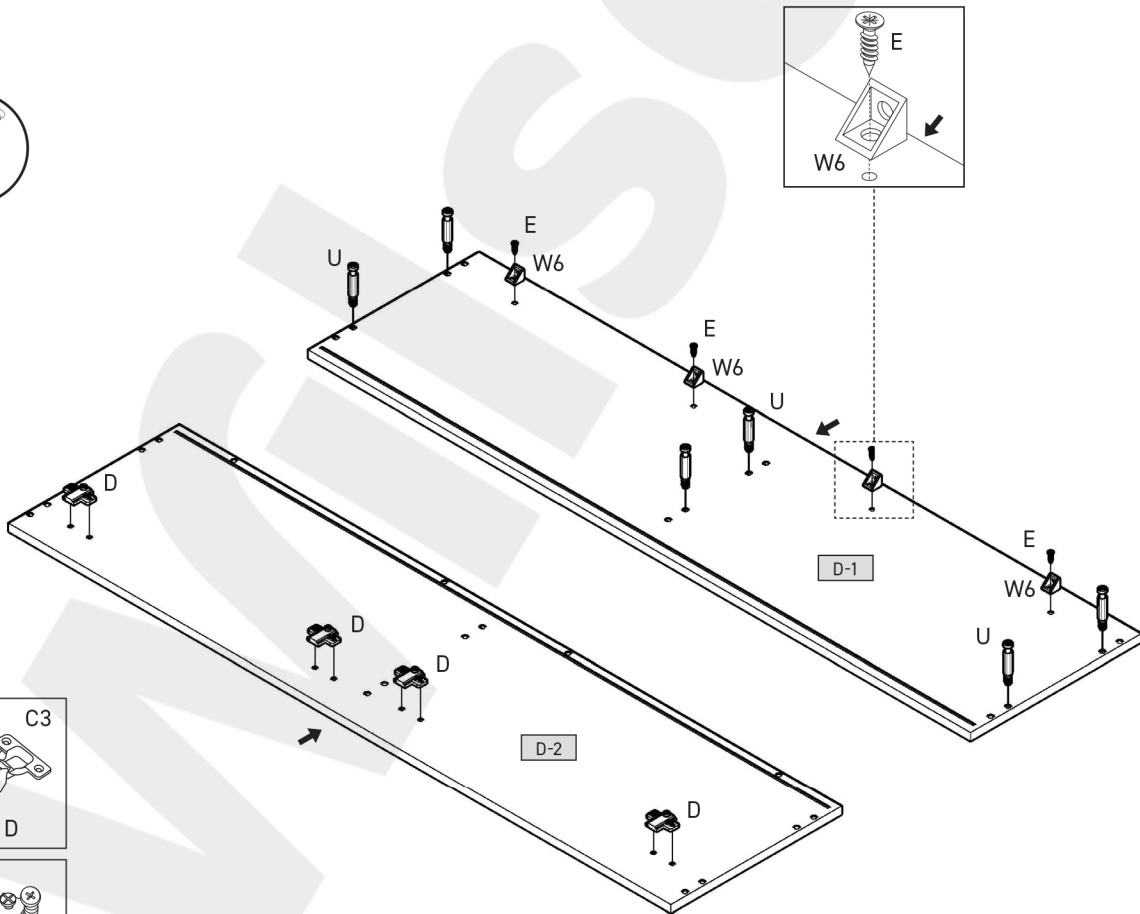

SENSO D

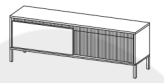

3

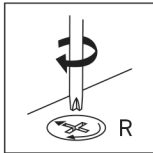
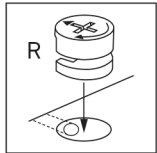
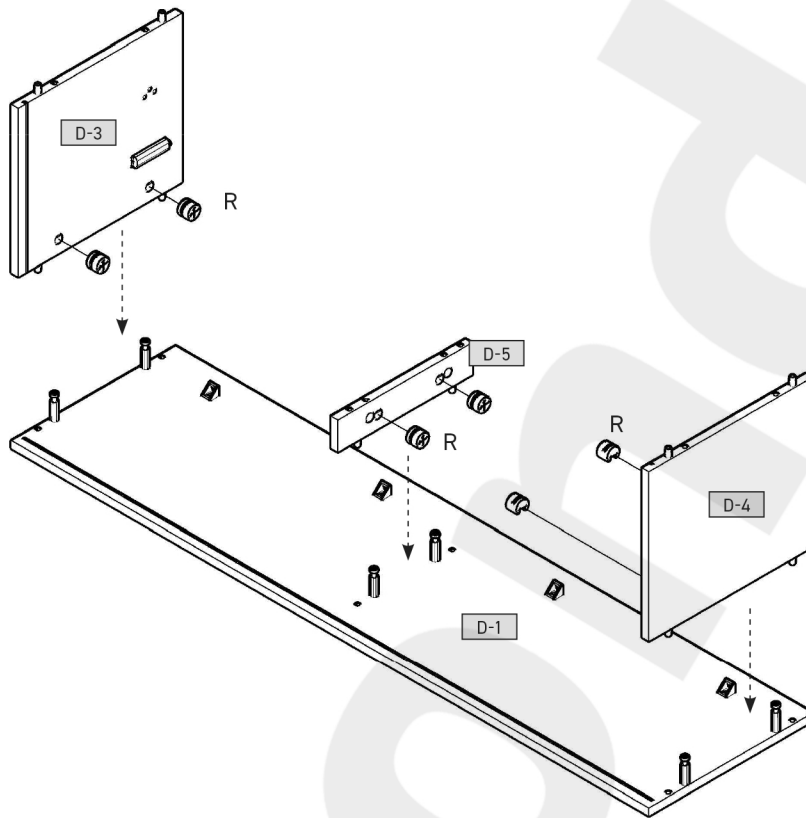
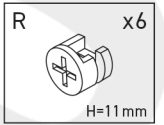

4

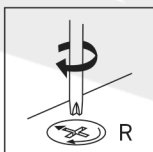
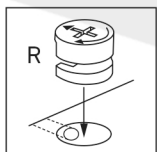
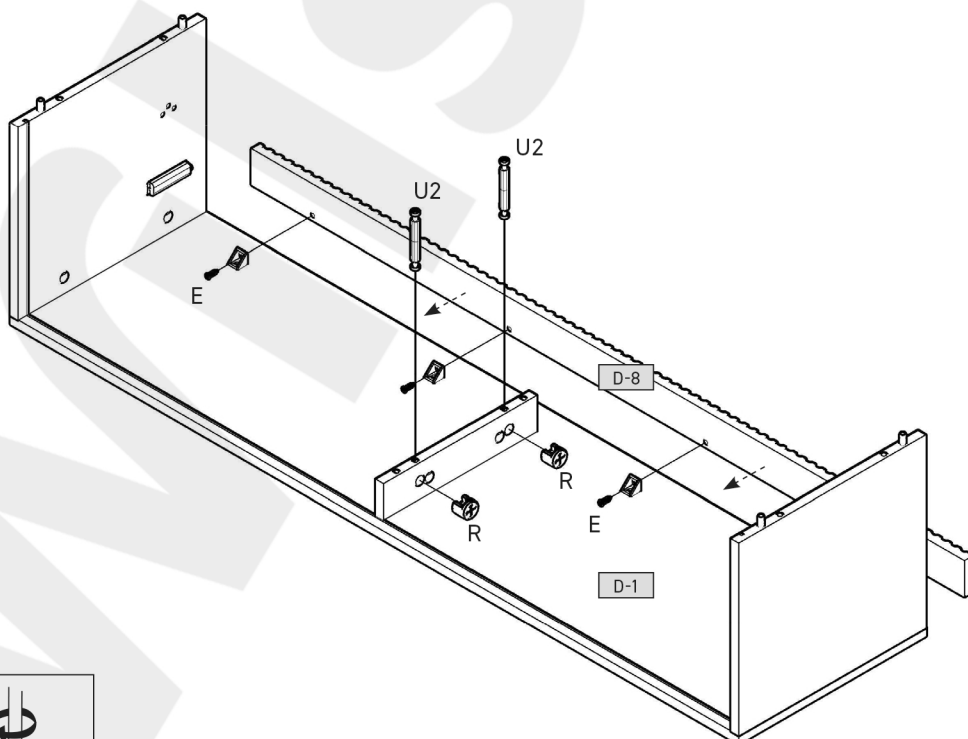
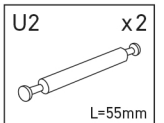
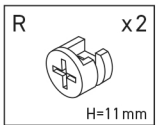
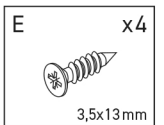

SENSO D

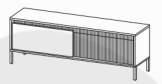

5

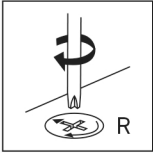
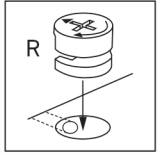
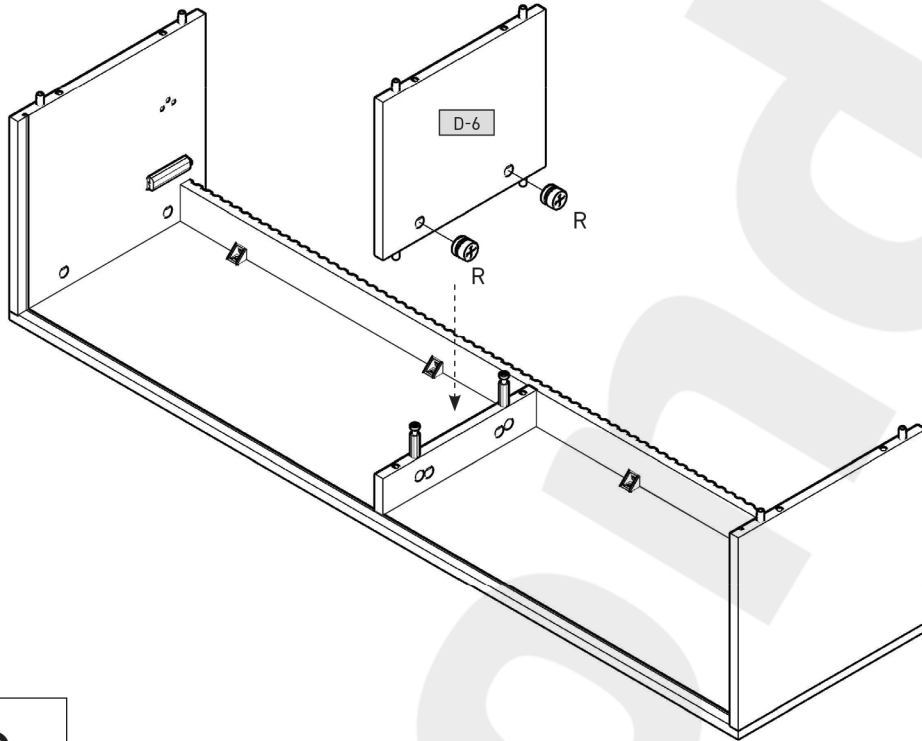
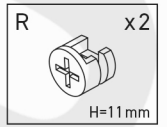

6

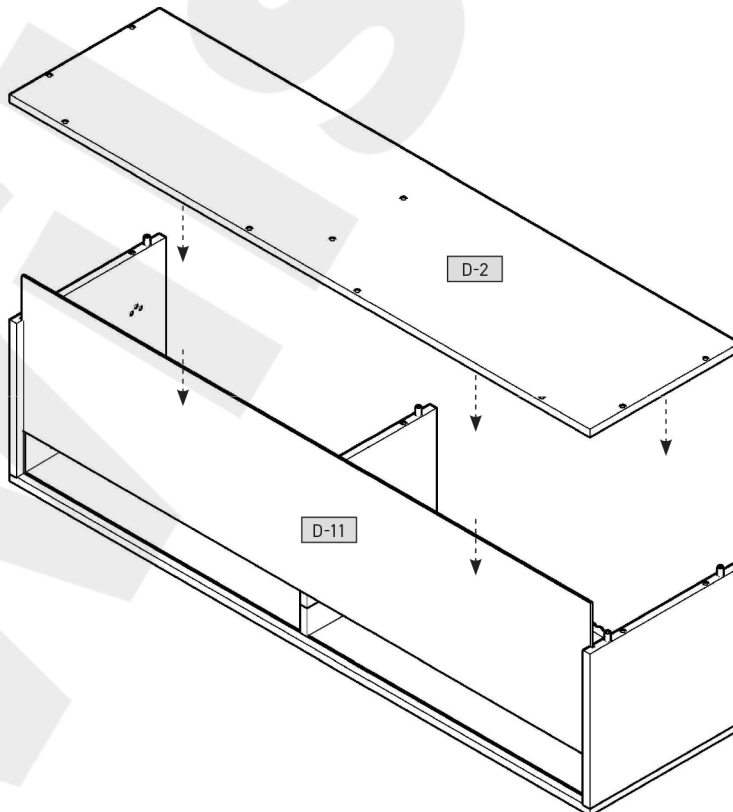

SENSO D

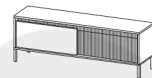

7

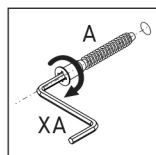
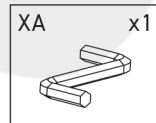
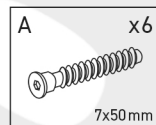
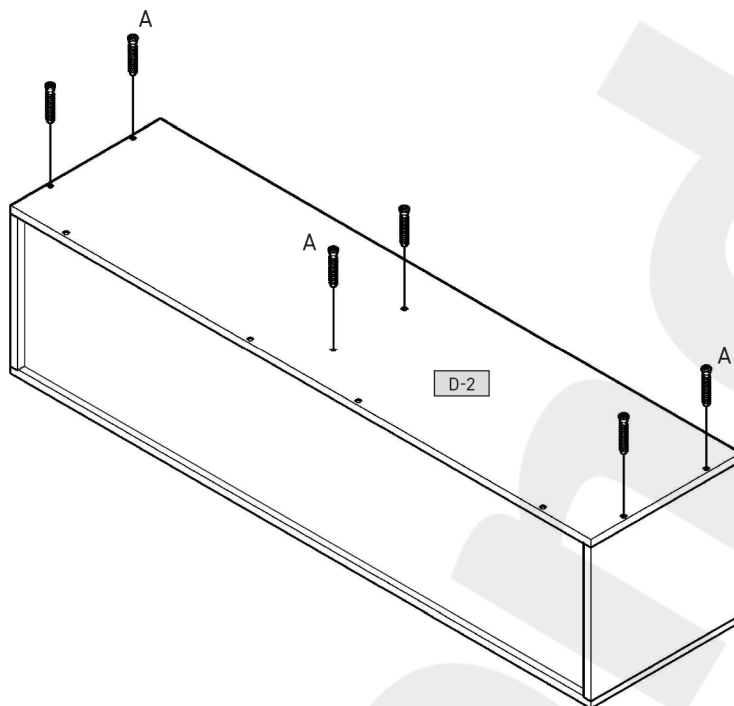

8

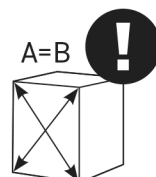
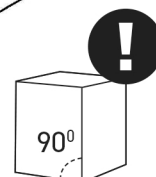
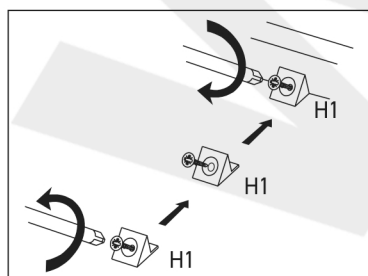
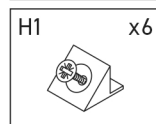
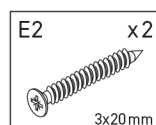
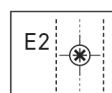
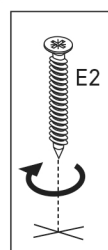
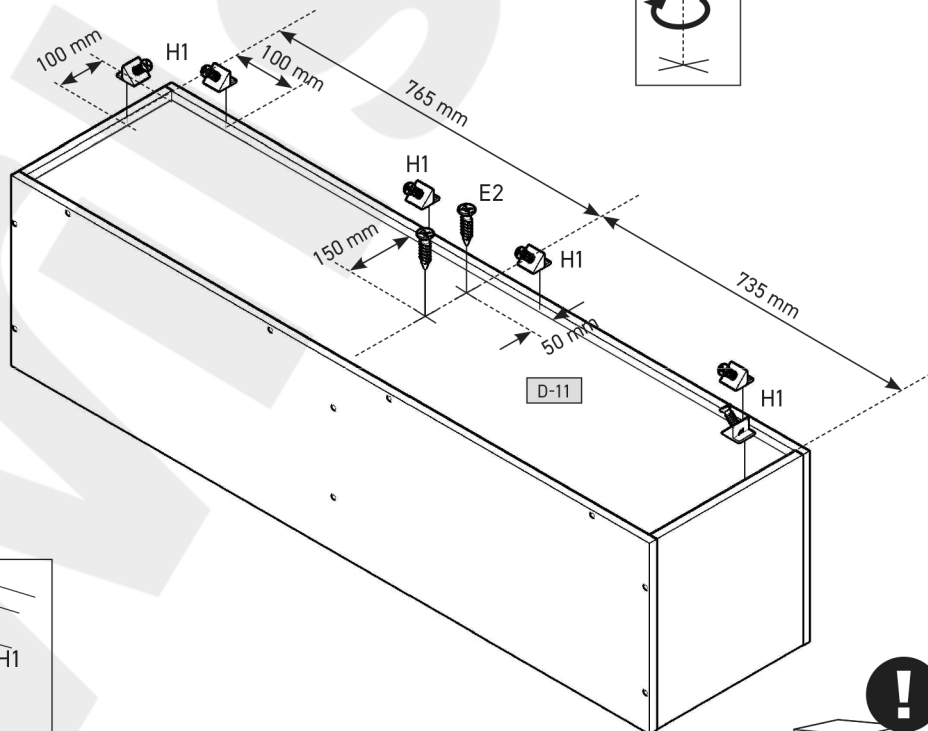

SENSO D

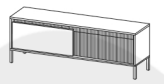

9

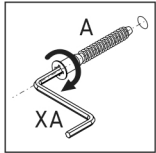
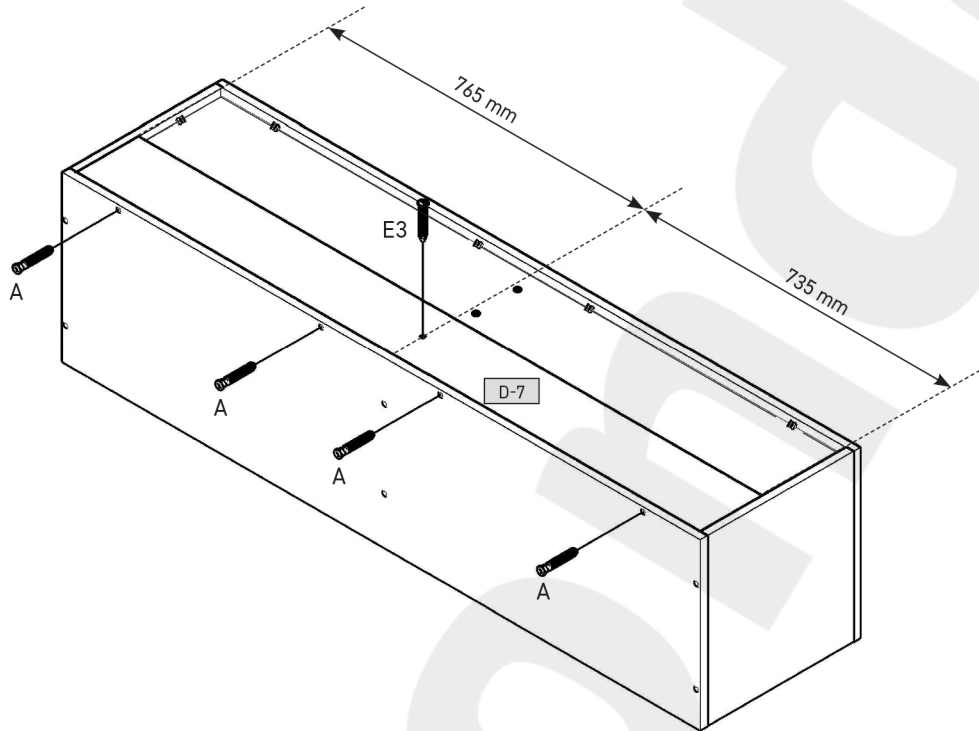
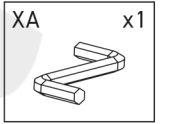
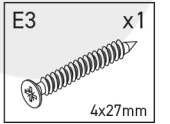
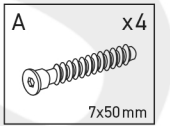

10

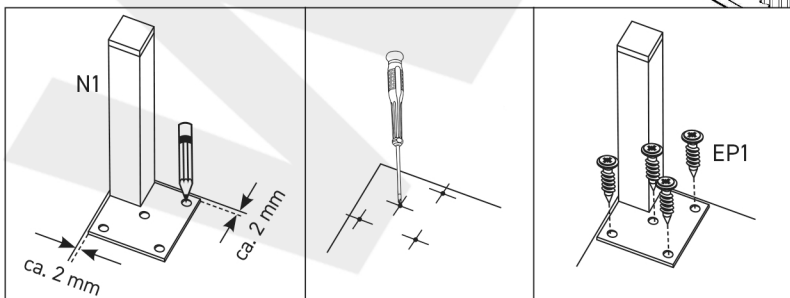
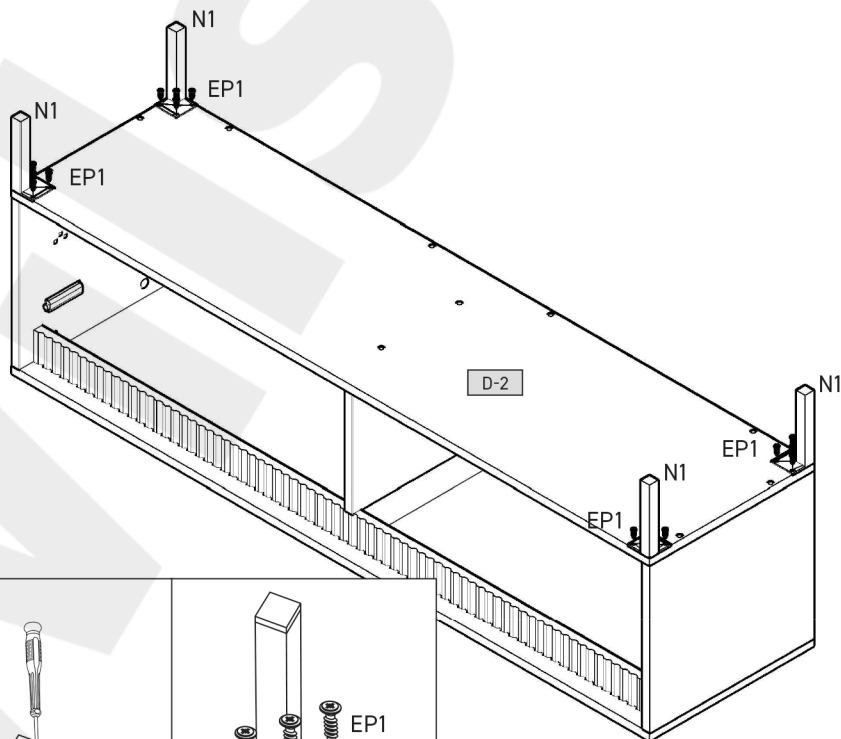
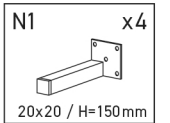
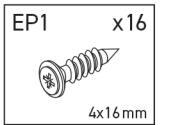

SENSO D

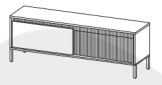

11

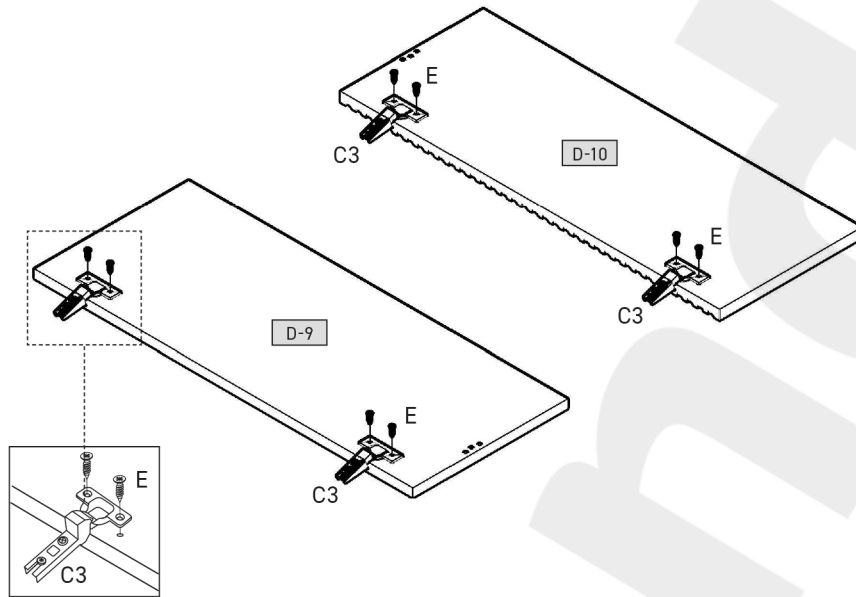
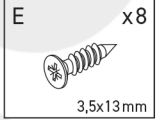
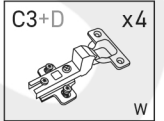

12

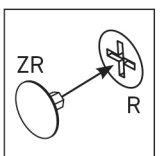
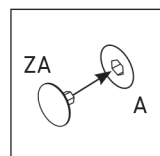
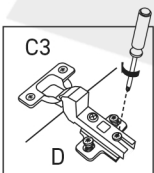
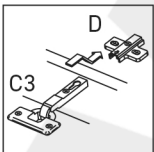
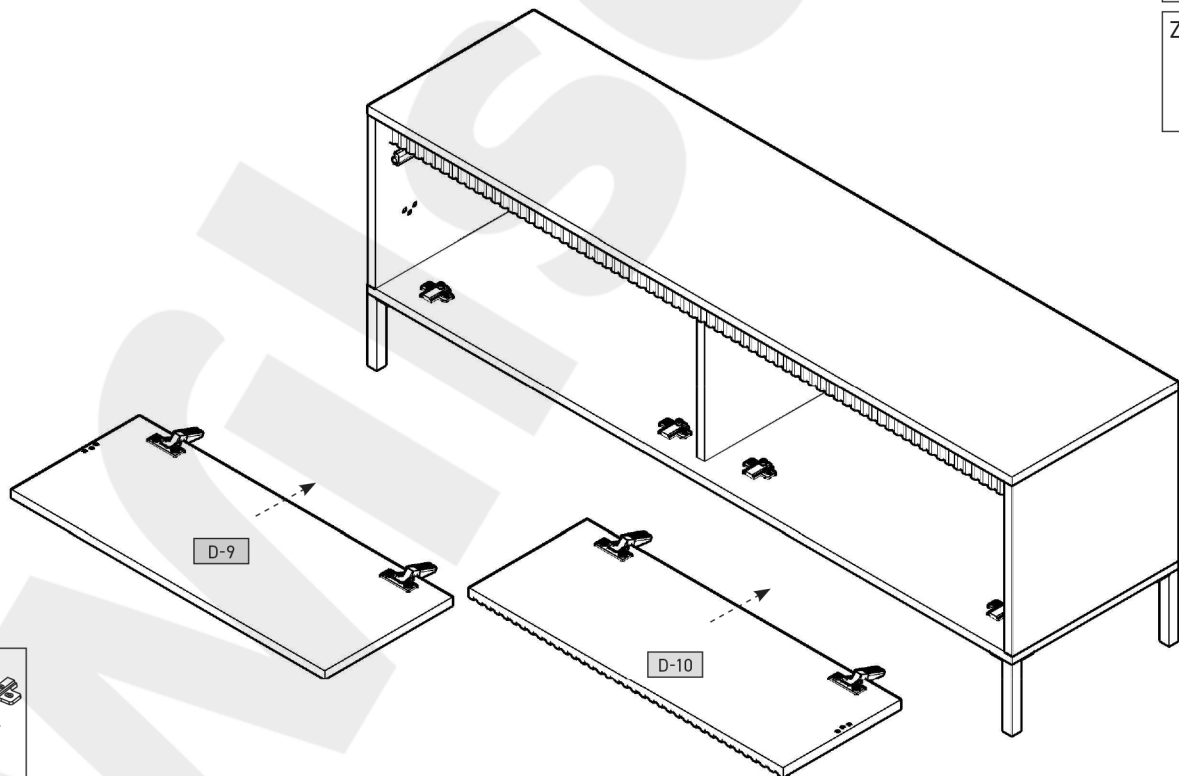
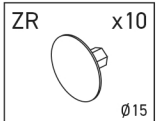

SENSO D

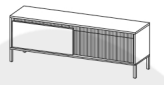

13

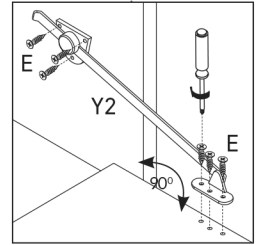
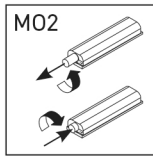
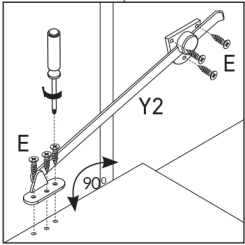
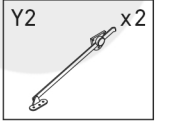
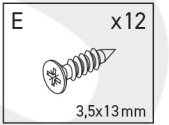
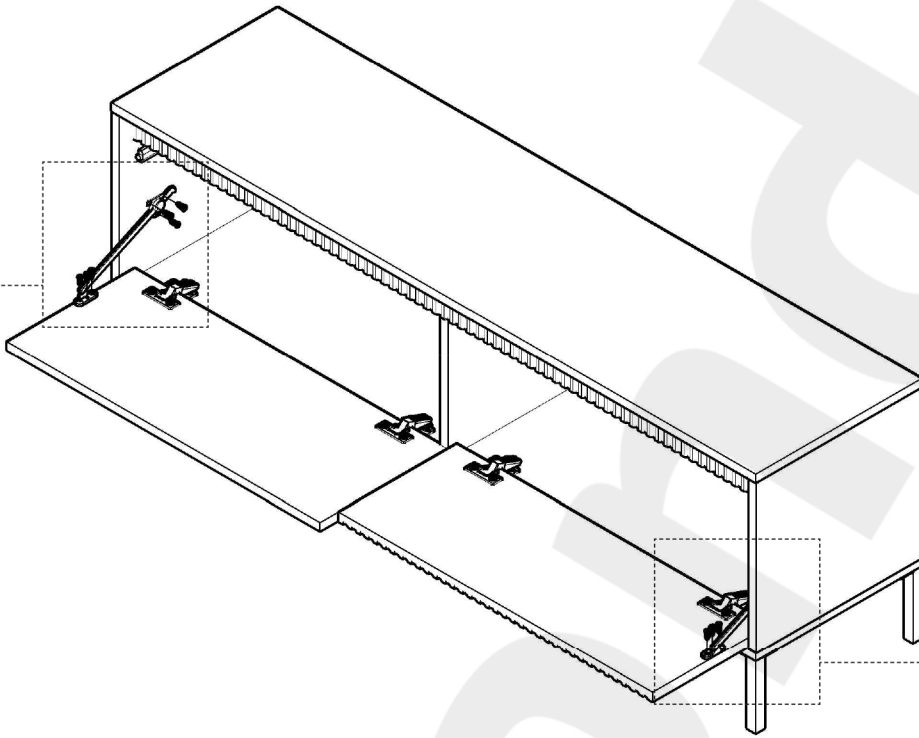
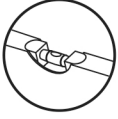

14

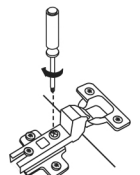
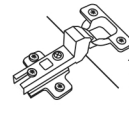
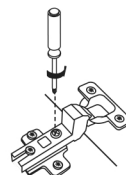
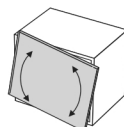
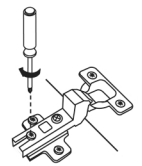
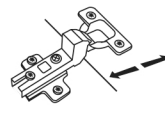
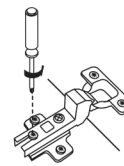
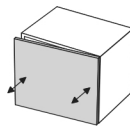
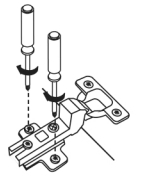
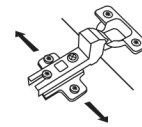
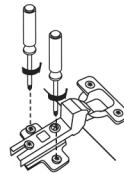
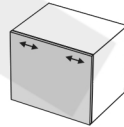
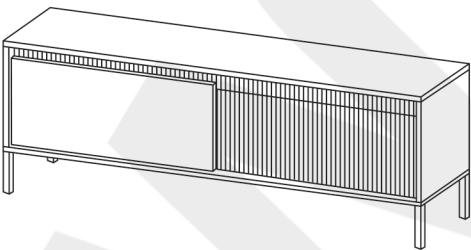

SENSO D

Nr. __ / Typ. D

Service • Assistenza • Dienstverlening • Serwis
 Servis • Szerviz • Сервисная служба

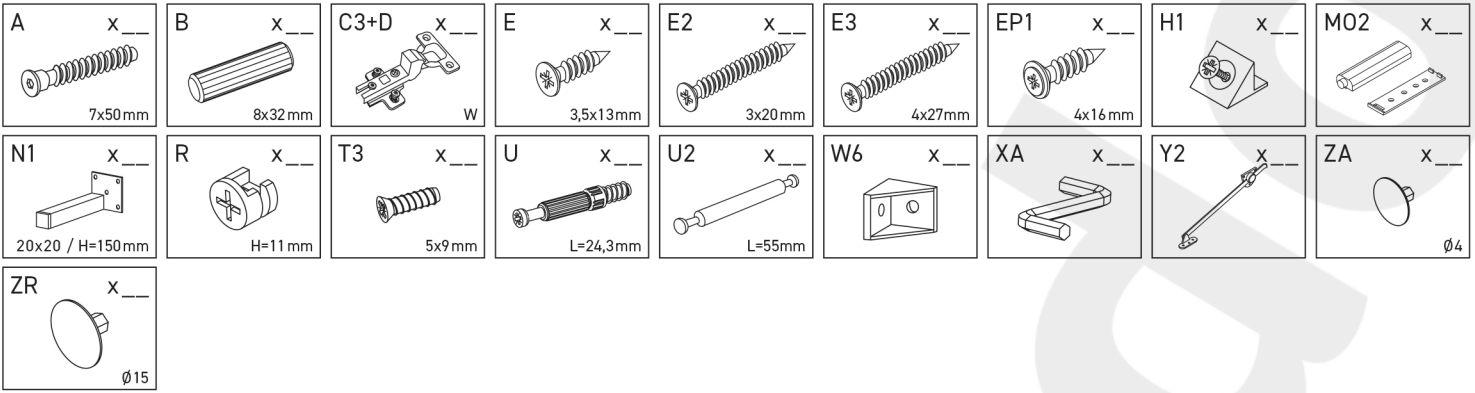

D-1	1535	395	16	x 1	1/1
D-2	1535	395	16	x 1	1/1
D-3	352	394	16	x 1	1/1
D-4	352	394	16	x 1	1/1
D-5	66	322	16	x 1	1/1
D-6	286	340	16	x 1	1/1
D-7	1502	150	16	x 1	1/1
D-8	1502	66	18	x 1	1/1
D-9	740	304	16	x 1	1/1
D-10	752	280	18	x 1	1/1
D-11	1516	366	3	x 1	1/1

