

- (D) Montageanleitung
- (GB) Assembly Instructions
- (FR) Notice de montage
- (IT) Istruzioni di montaggio
- (NL) Handleiding voor de montage
- (PL) Instrukcja montażu
- (CZ) Montážní návod
- (SK) Návod na montáž
- (HU) Szerelési útmutató
- (RO) Instrucțiuni de montaj
- (TR) Montaj talimatı
- (RU) Инструкции по монтажу
- (E) Instrucciones de montaje

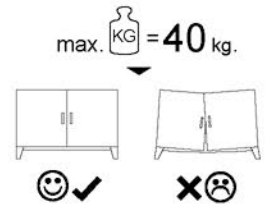
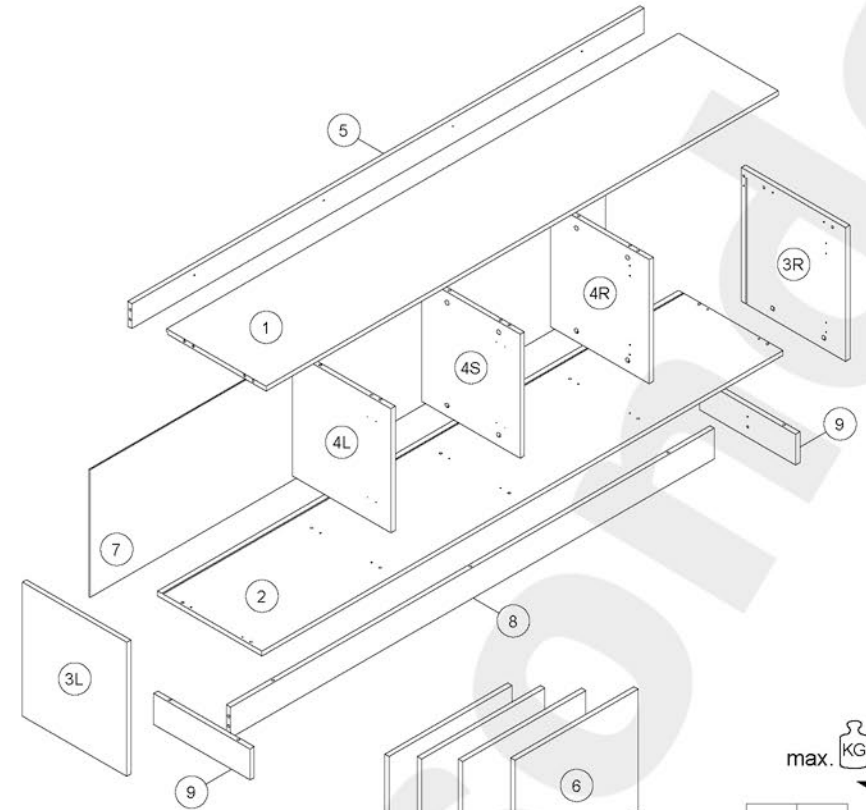

A	8x32	B	x31	C	x28	GLUE	x1
H0	x8	KG	x4	N	3x20	ND	3.5x16
ST	x1	SPO	x7	W	x8	X	x11
						Z	x16

	1916	373	16	x1	1 / 2
1	1916	373	16	x1	1 / 2
2	1949	390	16	x1	1 / 2
3L	434	390	16	x1	2 / 2
3R	434	390	16	x1	2 / 2
4L	402	369	16	x1	2 / 2
4S	402	369	16	x1	2 / 2
4R	402	369	16	x1	2 / 2
5	1916	80	16	x1	1 / 2
6	396	461	16	x4	2 / 2
7	1928	414	2.5	x1	1 / 2
8	1809	100	16	x1	1 / 2
9	360	100	16	x2	1 / 2

14.04.2026

⚠ **Uwaga • Upozornění • Achtung • Attention • Caution • Flygelem**  
**Attenzione • Opgelet • Внимание • Atenție • Upozornenie • Dikkat** ⚠

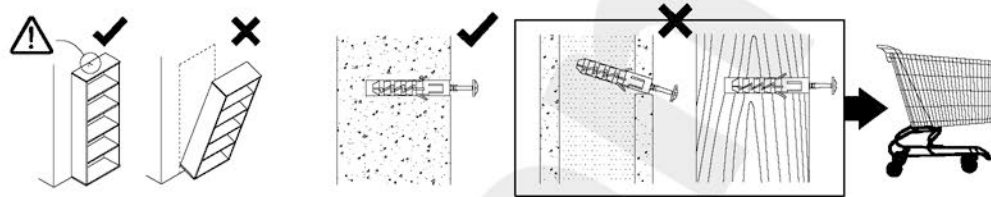
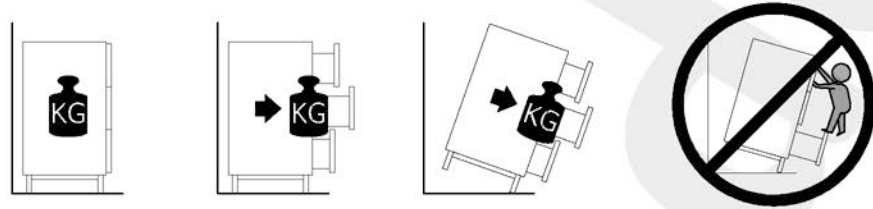

⚠ **Uwaga • Upozornění • Achtung • Attention • Caution • Flygelem**  
**Attenzione • Opgelet • Внимание • Atenție • Upozornenie • Dikkat** ⚠

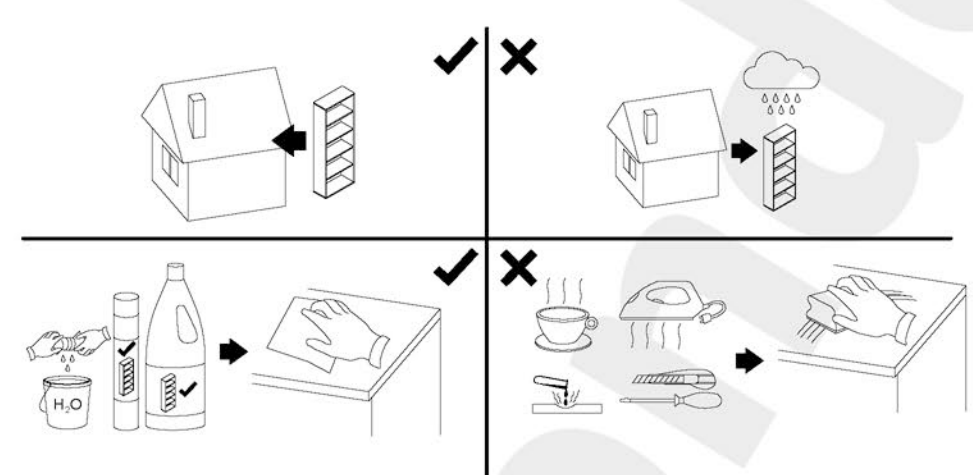

PL	Mocowanie do ściany jest jednocześnie zabezpieczeniem przed przewróceniem - konieczne zamontować! Do niektórych rodzajów ścian konieczne zastosować specjalne kołki mocujące.
CZ	Montáž na stěnu slouží jako ochrana proti převrnutí - bezpodmínečně umístěte! U některých typů stěn může být zapotřebí speciální hmoždinka!
DE	Wandbefestigung dient als Kippschutz - unbedingt anbringen! bei einigen Wandtypen kann ein Spezialdübel erforderlich sein!
GB	The wall fastening serves to prevent tipping - be absolutely sure to mount it! For certain wall types, a special wall plug may be necessary!
FR	La fixation murale sert de protection contre le basculement - à installer impérativement! Pour certains types de murs il faut des chevilles spéciales!
NL	De muurbevestiging is ook een anti-kantelbeveiliging - moet worden gemonteerd! Voor bepaalde soorten muren is het nodig speciale bevestigingspluggen te gebruiken.
IT	Il fissaggio alla parete serve da protezione anti-ribaltamento-attaccarla assolutamente! Per alcune strutture di parete può essere necessario un tassello speciale!
HU	A termékét a falhoz kel rögzíteni, különben az felborulhat! Egyes fal típusoknál speciális tiplét kell használni!
RU	Обязательно установите крепление на стене во избежание опрокидывания! Для некоторых типов стен может потребоваться специальный дюбель!
RO	Sistemul de fixare la perete servește ca protecție la răsturnare - de montat obligatoriu! Pentru unele tipuri de pereți este posibil să fie necesar un diblu special!
SK	Upevnenie na stenu slúži ako ochrana proti prevráteniu - bezpodmienečne použite! Pre niektoré druhny stein môže byť potrebná špeciálna hmoždinka!
TR	Duvardaki sabitleme, devrilmeye karşı bir emniyet tedbiridir ve mutlaka monte edilmelidir! Bazi duvar tiplerinde bunun için özel bir dübel gerekli olabilir!
E	Fijarlo a la pared también protege contra vuelcos. ¡Asegúrese de instalarlo! Para algunos tipos de paredes, es necesario utilizar pasadores de montaje especiales.

PL	Czyszczenie należy wykonać wyłącznie za pomocą ściereczki lub lekko nawilżonego ręcznika. Nie stosować środków czyszczących do szorowania.
CZ	Čištění je nutné vykonávat výhradně pomocí utěrky nebo lehce navlženého ručníku. Nepoužívejte čisticí prostředky obsahující abrazivní částice.
DE	Bitte nur mit einem Staubtuch oder leicht feuchtem Lappen reinigen. Keine scheuernden Putzmittel verwenden.
GB	Please only clean with a duster or damp cloth. Do not use any abrasive cleaners.
FR	Le nettoyage se fait uniquement à l'aide d'un torchon ou d'une serviette légèrement mouillée.
NL	Reinigen met een zachte doek of een licht vochtige doek. Geen schurende middelen gebruiken.
IT	Pulire esclusivamente con un panno o un asciugamano umido.
HU	A tisztítás kizárólag törölrüha vagy enyhén nedvesített törölköző segítségével végezhető. Súroló hatású tisztítószereket nem szabad használni.
RU	Очищайте от пыли тряпкой или слегка влажной ветошью. Не допускается применение чистящих средств, не предназначенных для ухода за мебелью.
RO	Curățarea trebuie efectuată numai cu o cârpă sau cu un prosop ușor umezit. Nu utilizați agenți de curățare abrazivi.
SK	Čistení je nutné vykonávať výhradne pomocí utierky alebo ľahko zvlhnutým ručníkom. Nepoužívajte čistiace prostriedky obsahujúci abrazívne častice.
TR	Lütfen sadece bir toz beziyile veya hafif nemli yumuşak bir bezle siliniz. Aşındırıcı temizlik malzemeleri kullanmayınız.
E	La limpieza debe realizarse únicamente con un paño o una toalla ligeramente humedecida. No utilizar productos de limpieza abrasivos.

1

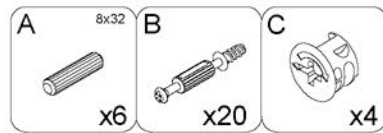
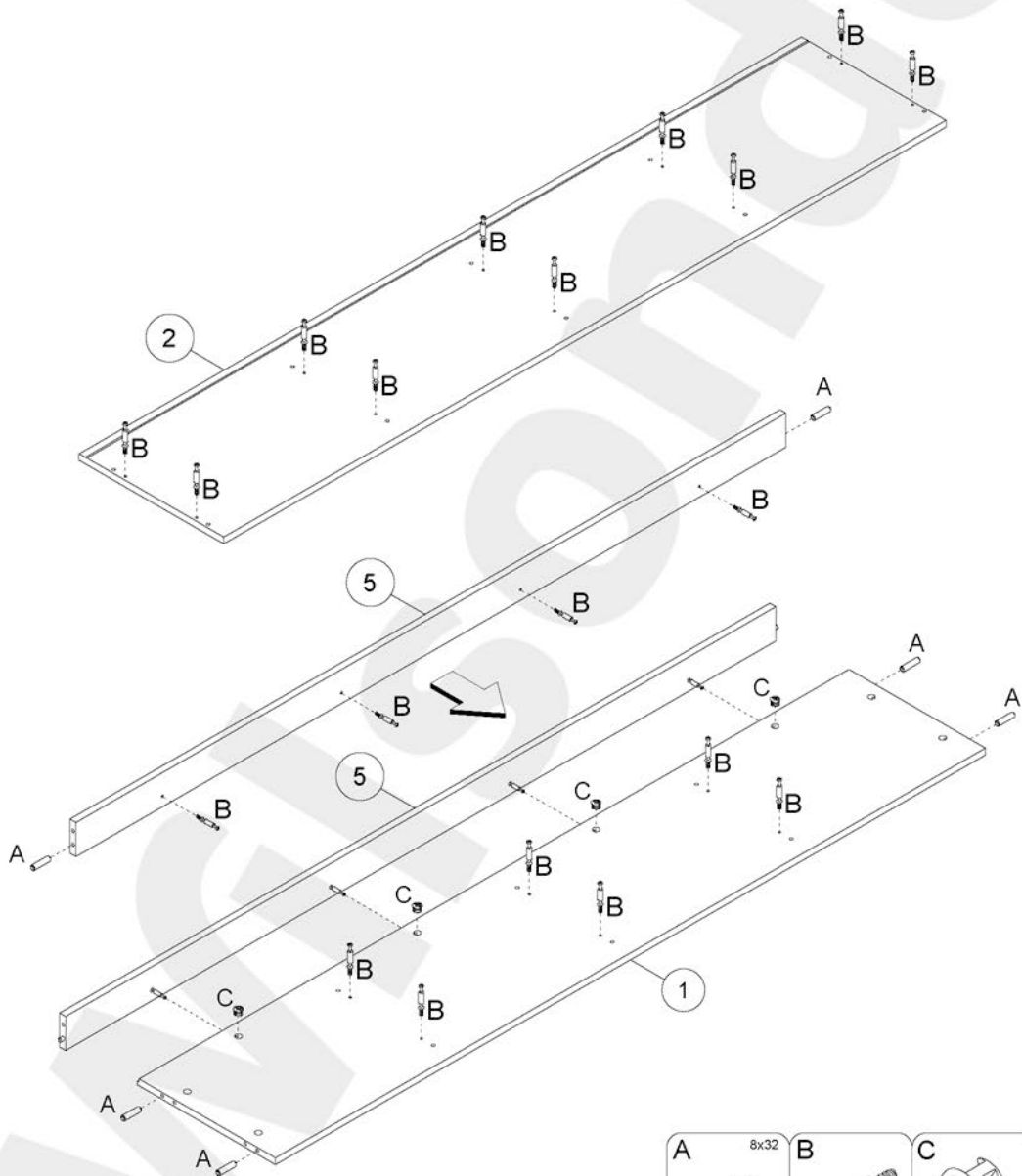
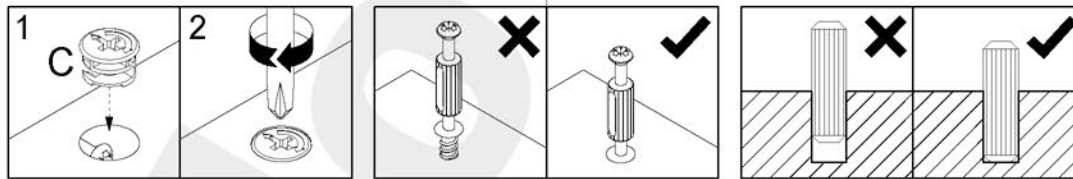

2

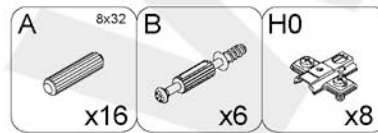
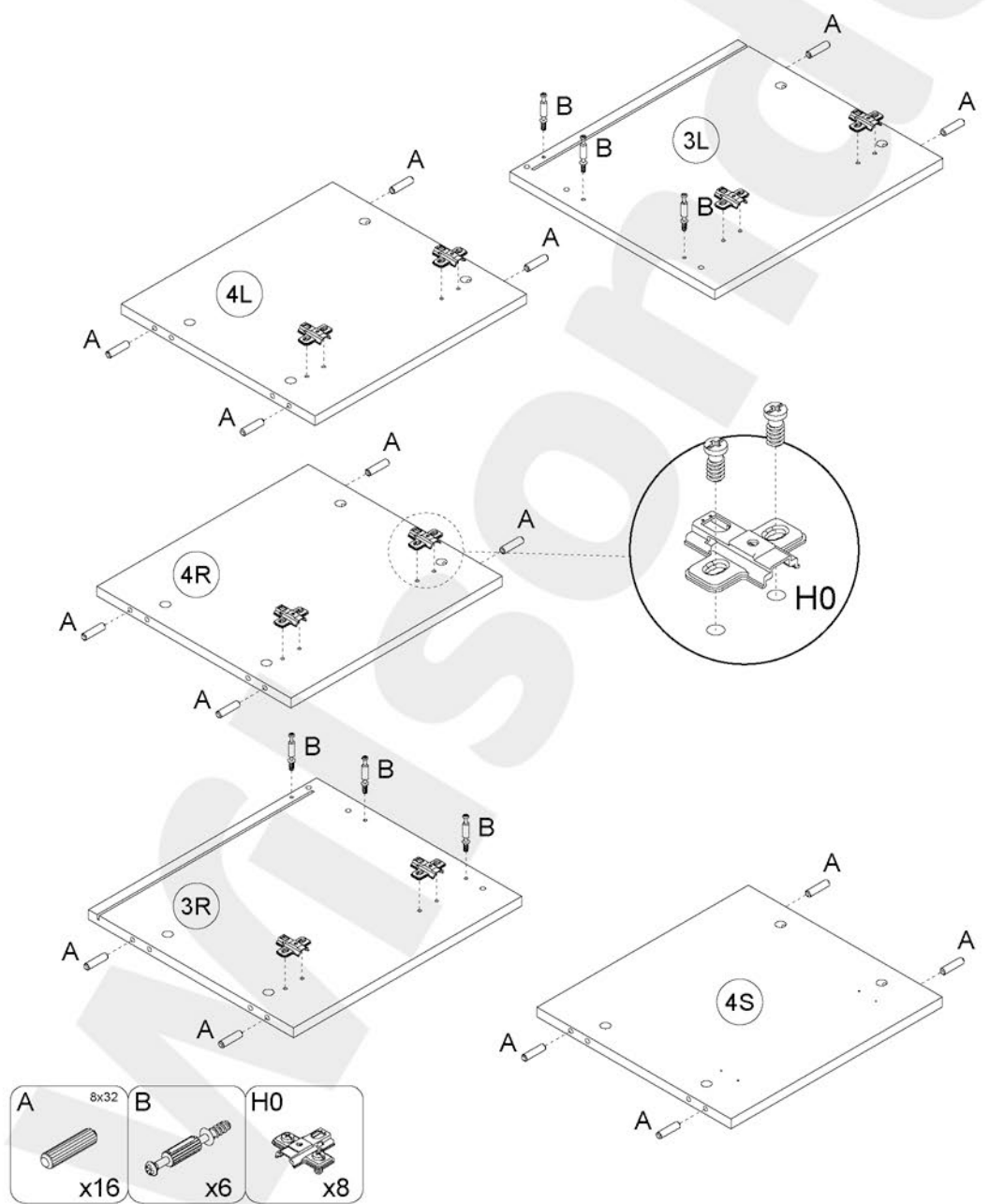

3

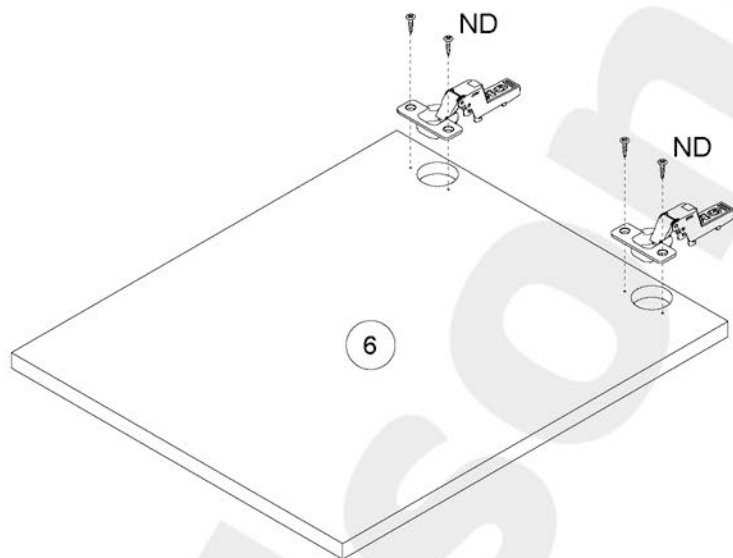
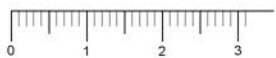
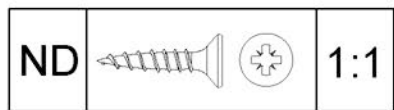

x4

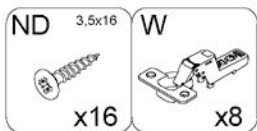
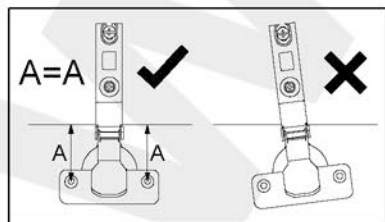

4

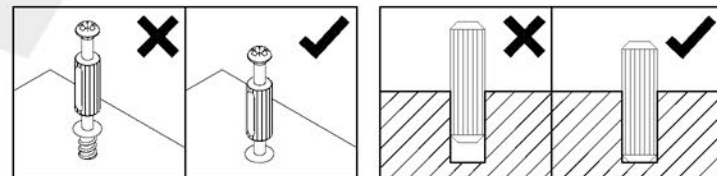
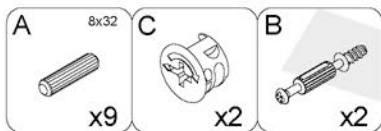
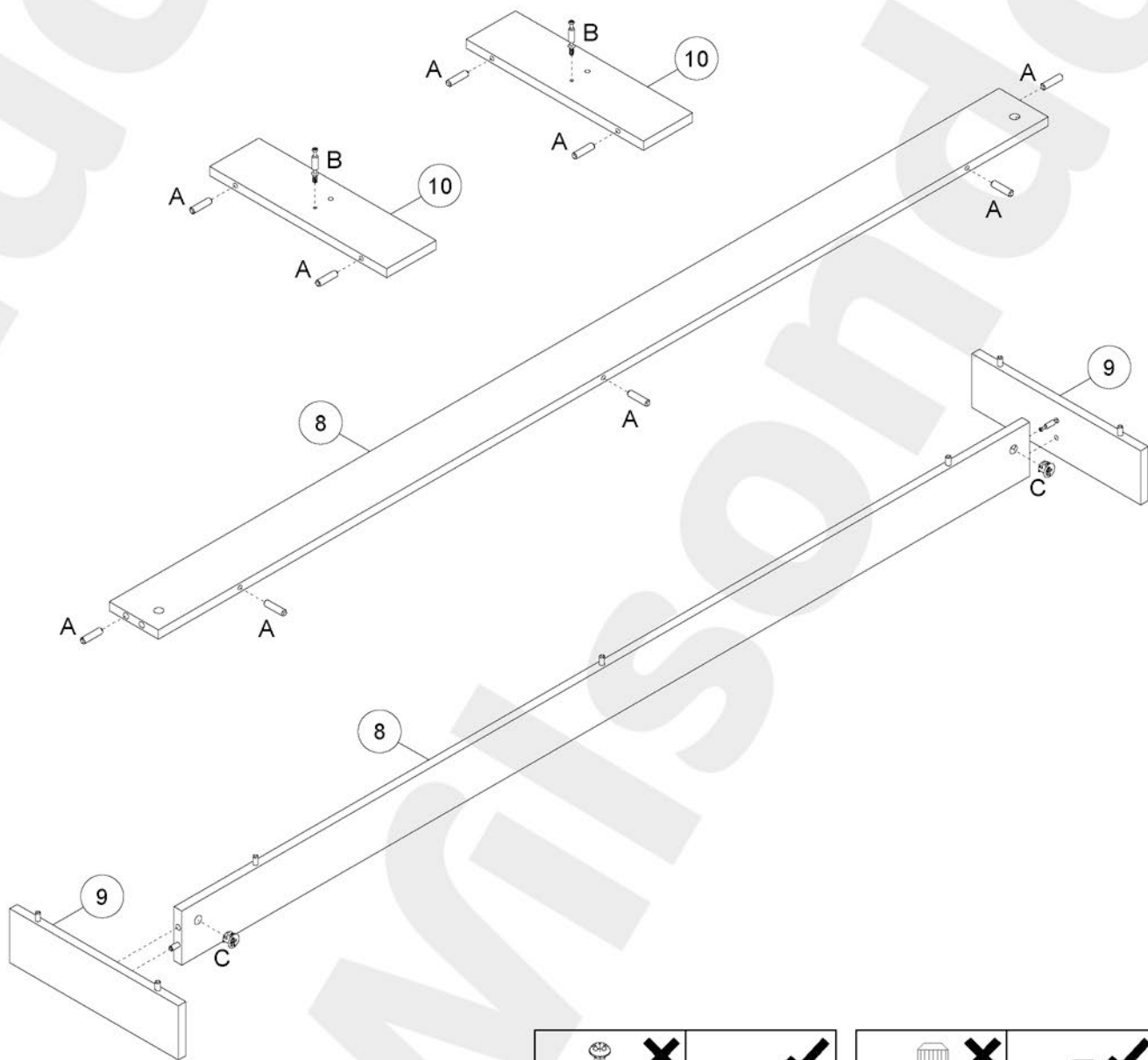

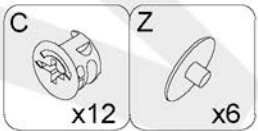
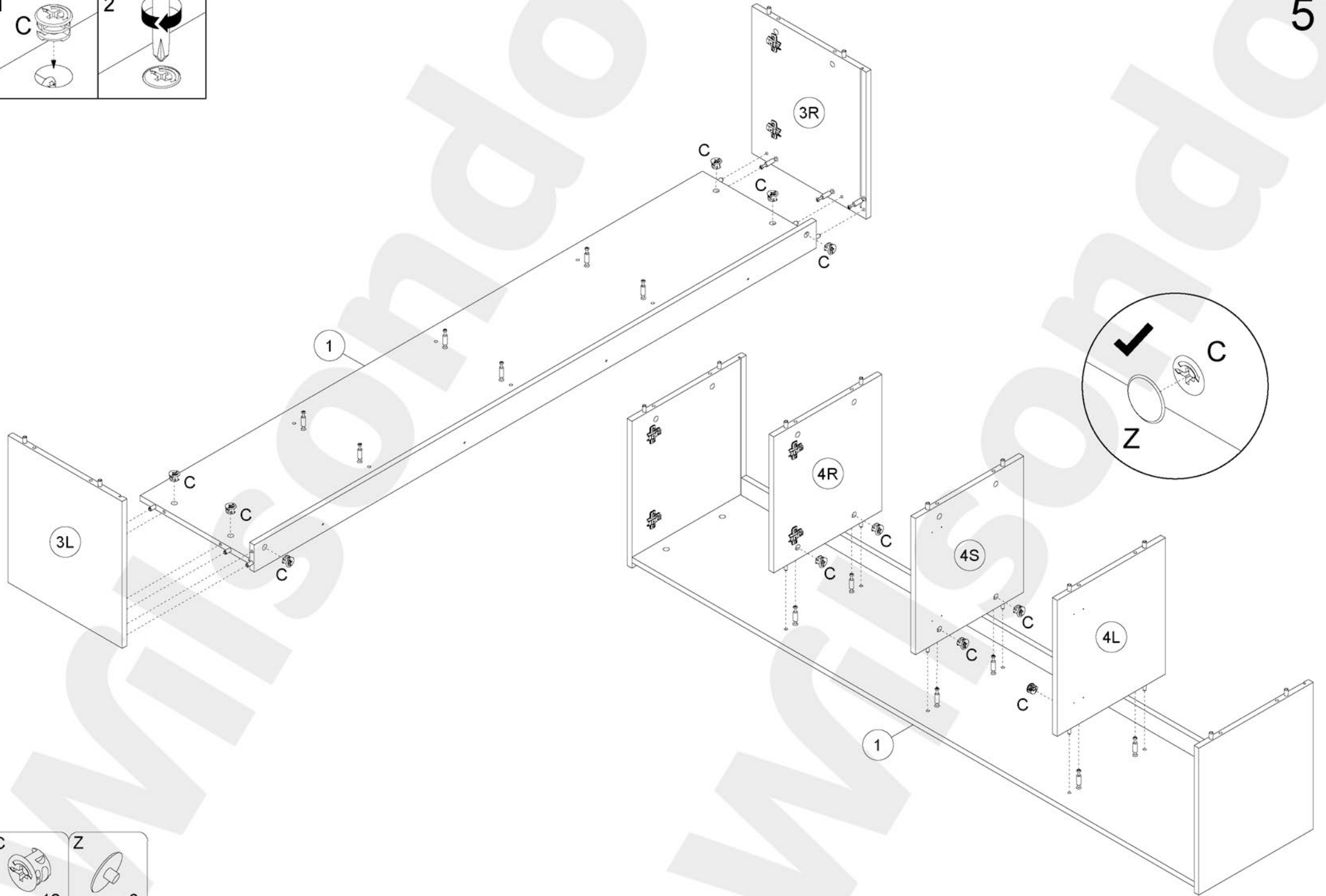
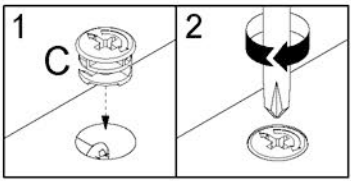

6

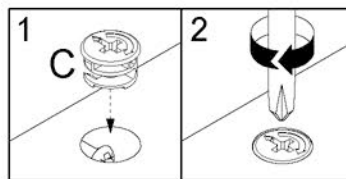
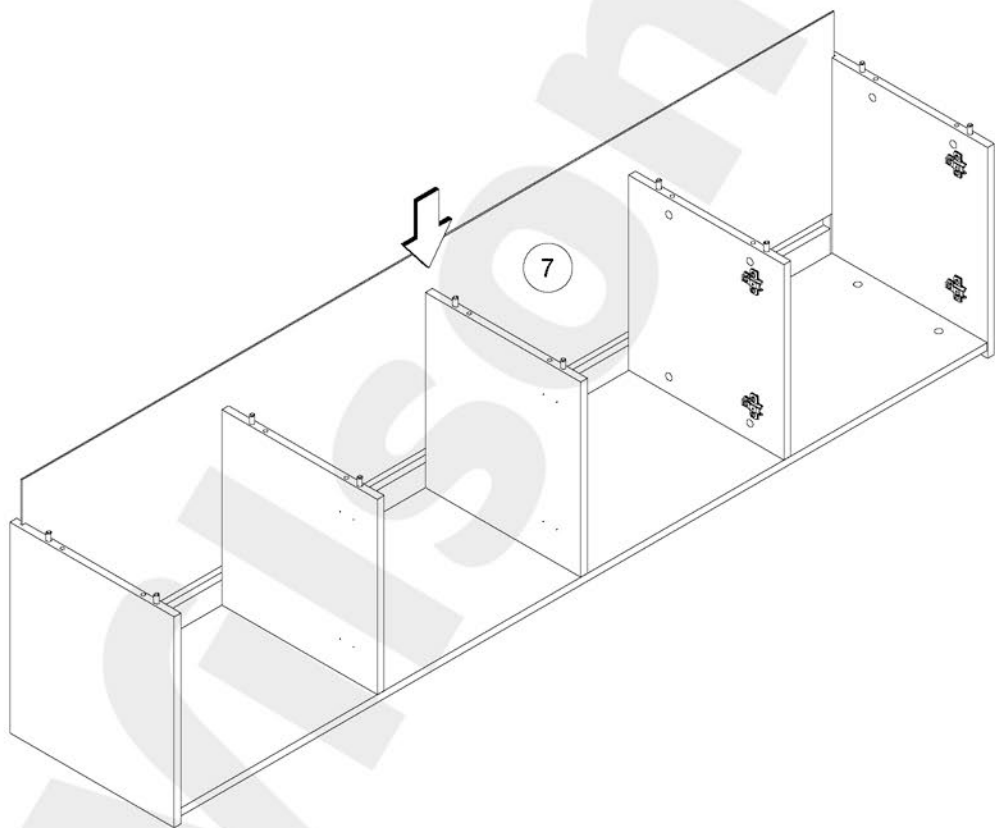

7

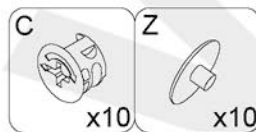
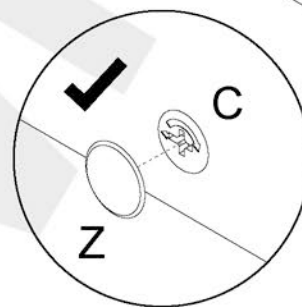
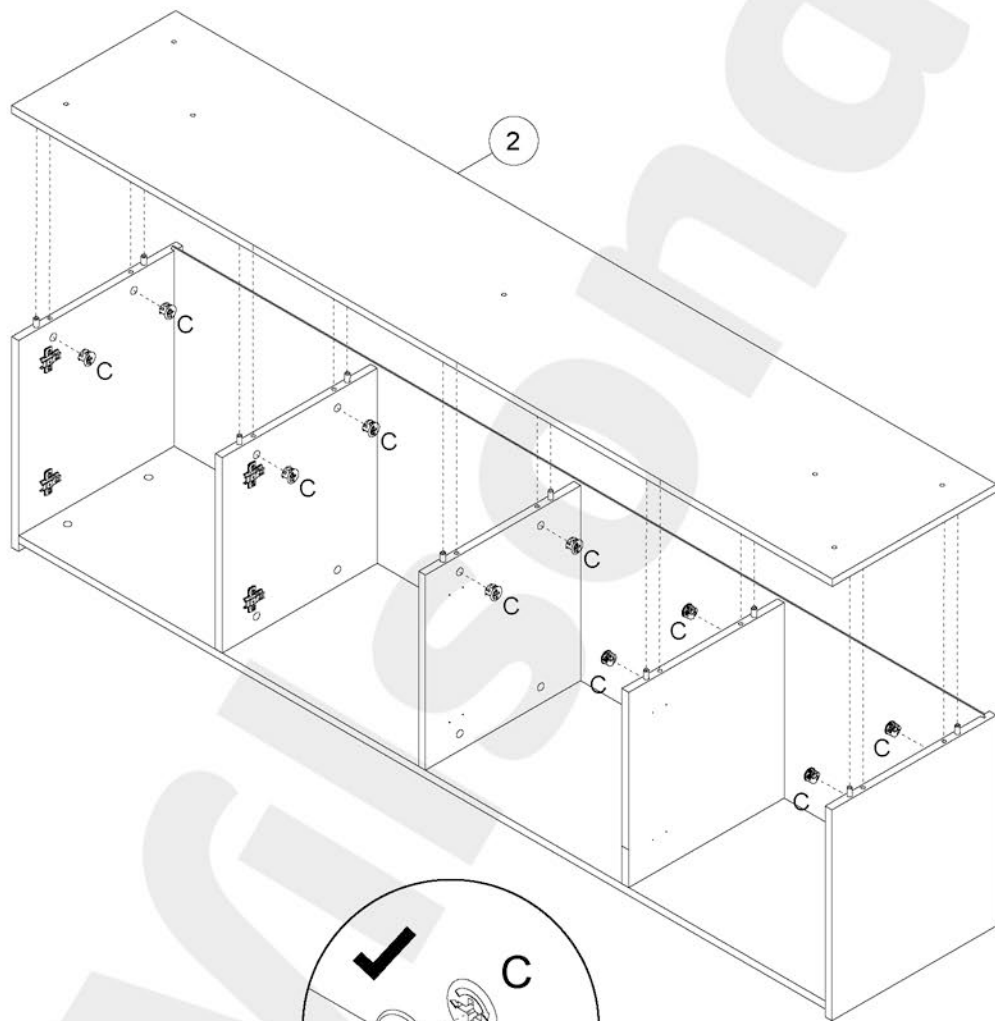



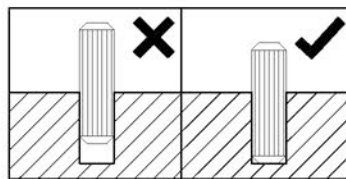
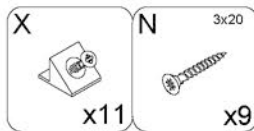
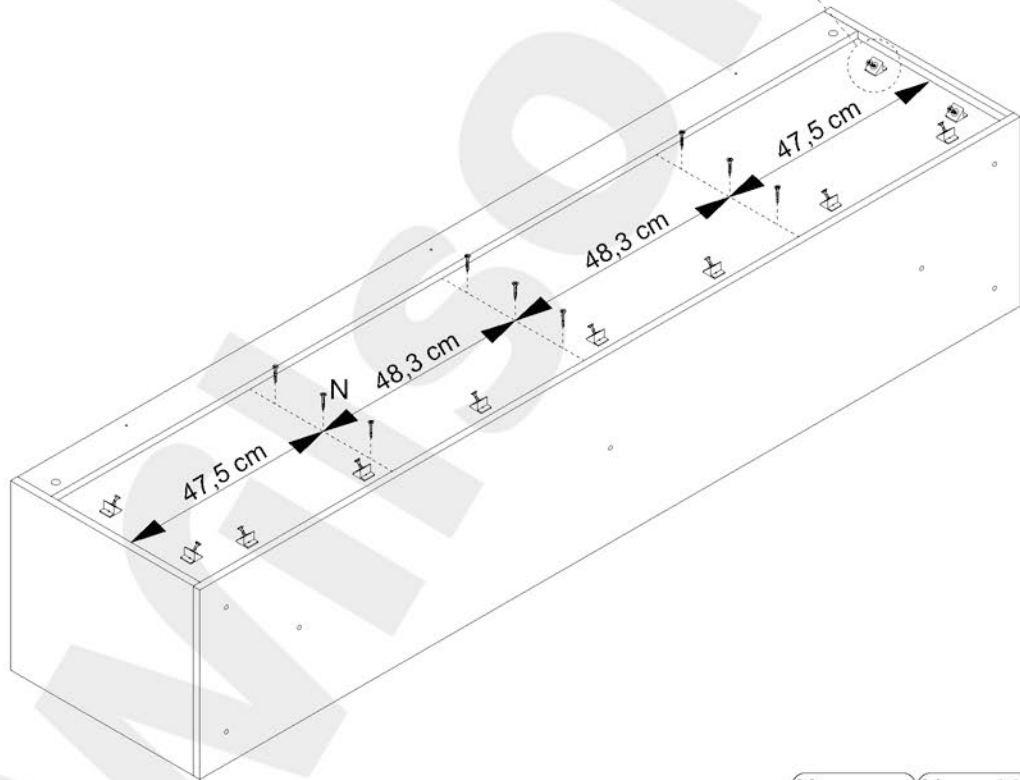
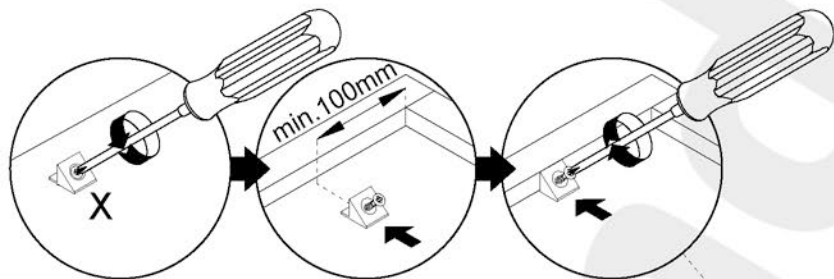
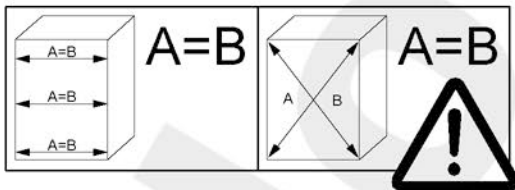
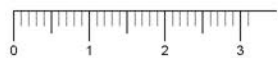
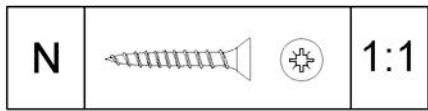

8

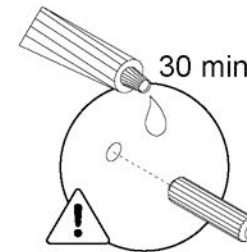
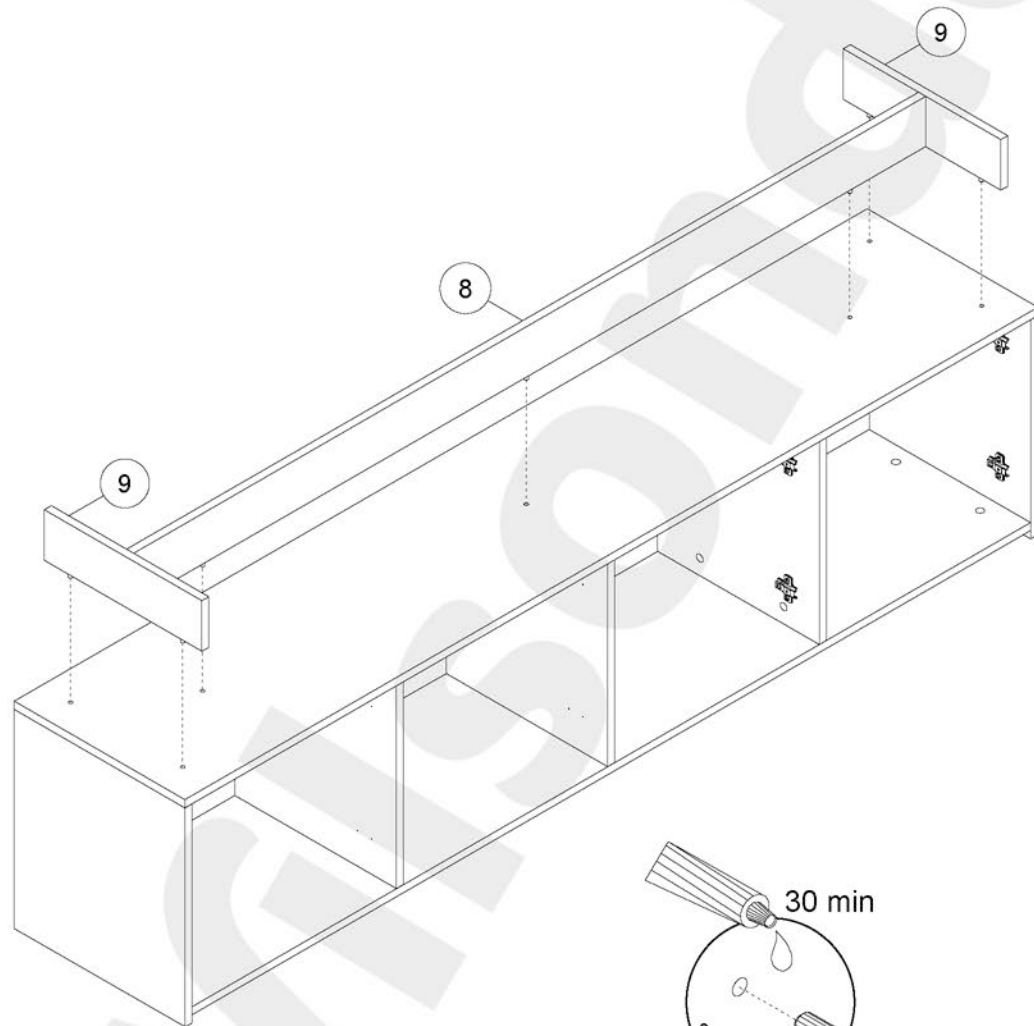

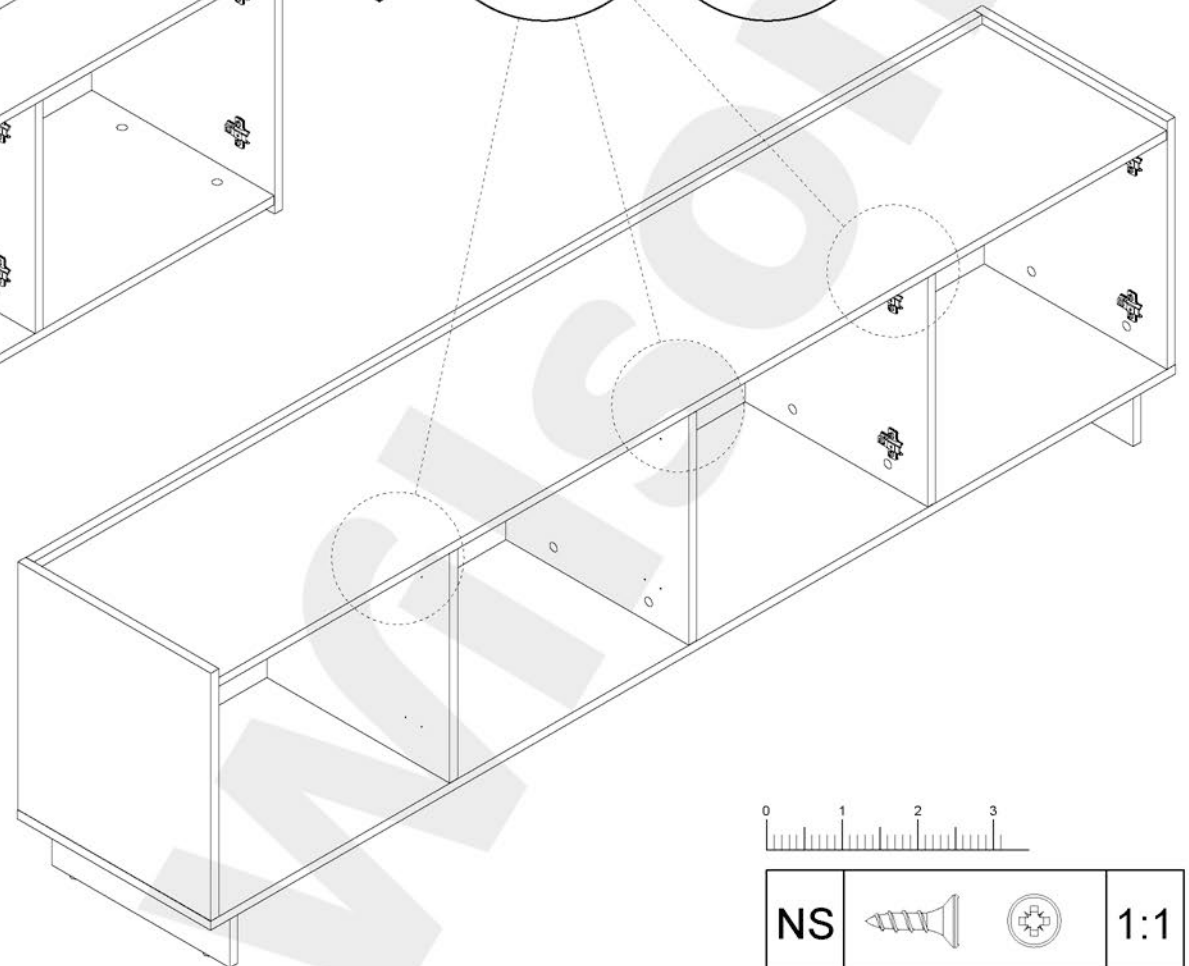
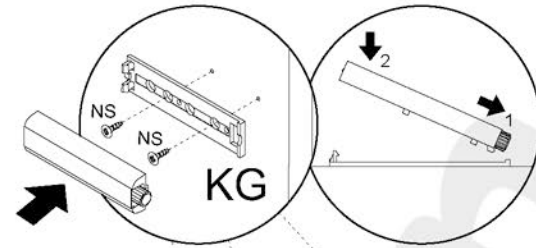
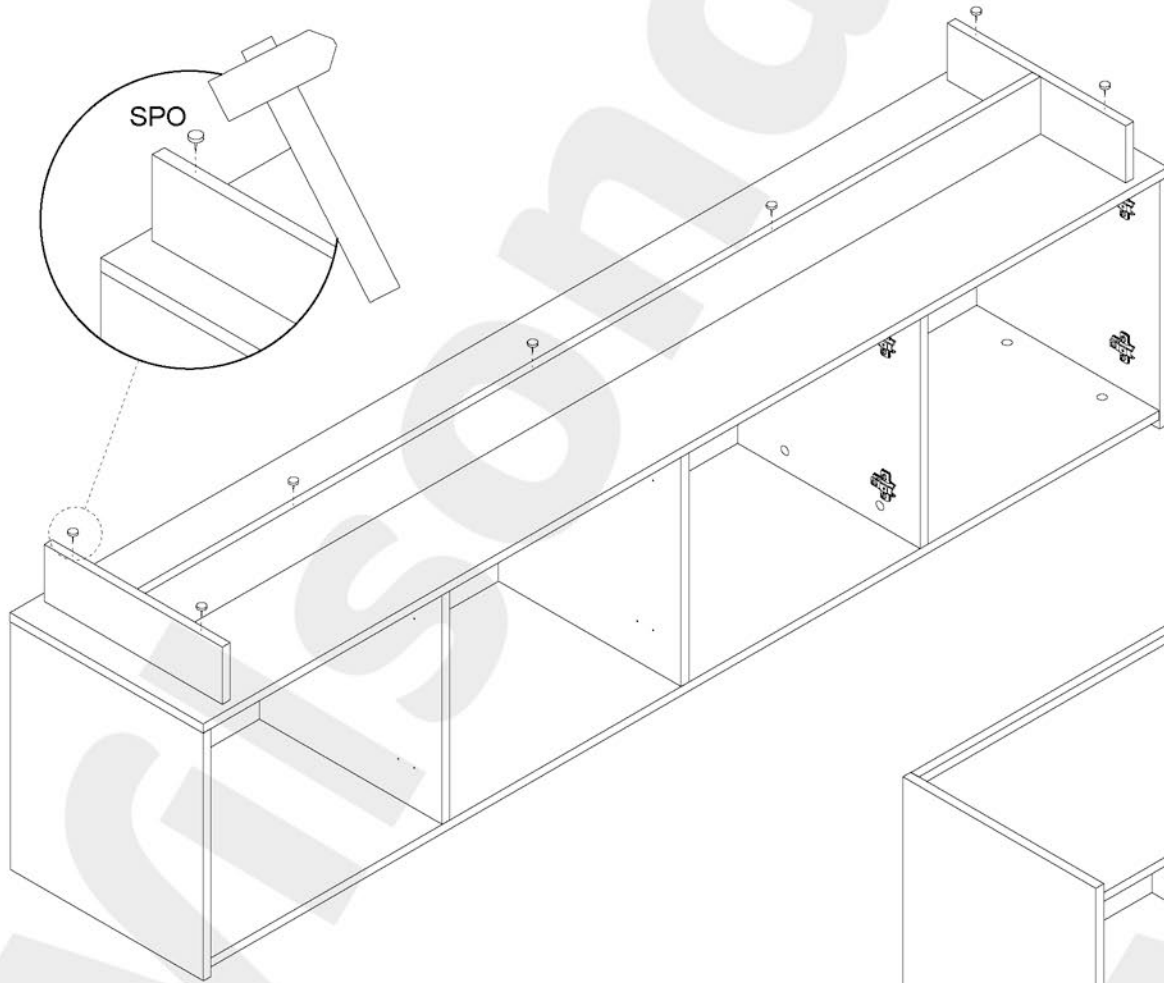

9





<b>SPO</b>  x7	<b>KG</b>  x4	<b>NS 3,5x13</b>  x8
--	--	---



<b>NS</b>			<b>1:1</b>
-----------	---	---	------------

